



Inrush current mitigation in three-phase transformers with isolated neutral



Ramón Cano-González^{a,*}, Alfonso Bachiller-Soler^a, José Antonio Rosendo-Macías^a, Gabriel Álvarez-Cordero^b

^a Department of Electrical Engineering, University of Sevilla, Escuela Superior de Ingenieros, Camino de los Descubrimientos s/n, 41092 Sevilla, Spain

^b Red Eléctrica de España (Spanish TSO), Paseo del Conde de los Gaitanes 177, 28109 Alcobendas, Madrid, Spain

ARTICLE INFO

Article history:

Received 29 July 2014

Received in revised form

28 November 2014

Accepted 30 November 2014

Available online 18 December 2014

Keywords:

ATP-EMTP

Controlled switching

Inrush current

Power transformer

Residual flux

Isolated neutral

ABSTRACT

In this paper, a new method for inrush current mitigation of three-phase transformers with isolated neutral is presented. The method uses controlled switching and requires independent-pole-operated circuit breakers. Two switching operations are proposed at time instants that achieve optimal mitigation of inrush current.

© 2014 Elsevier B.V. All rights reserved.

1. Introduction

Uncontrolled energization of power transformers can create large flux asymmetries and saturation of the transformer magnetic core. This saturation results in high current magnitudes with a wide harmonic spectrum and a high direct-current component [1].

Inrush currents can cause false operation of protective relays [2,3], reduce transformer lifecycle [4,5], and usually reduce power quality on the system [6,7]. The magnitudes reached by these currents depend on two principal factors: the point on the voltage waveform at which the switches are closed; and the residual fluxes in the transformer core [8].

Several methods, such as series compensator [9,10], sequential phase energization with a grounding resistor [11,12] and controlled switching [1,8,13,14], have been developed to reduce the inrush current. Among these, the controlled switching that takes into account the core residual flux constitutes the most promising method. Its basic principle is to guarantee that the residual fluxes are equal to the prospective fluxes at the instant of energization.

A prospective flux is the steady-state flux if the supply source is already connected to the transformer.

The success of the controlled switching techniques requires independent pole operated circuit breakers, whose closing characteristics are stable and repeatable. The desired closing time deviations are less than ± 1 ms [13]. This could result in an additional cost which may be offset by the reduction of maintenance costs of the breaker and transformer [15]. However, when the safety and reliability of the power system are involved, the incremental cost of implementing controlled switching is negligible.

In particular, in [1,8], controlled energization has been applied to three-phase transformers whose neutral is earthed. In these cases, one phase is energized at the optimal point on the voltage waveform, and the remaining two phases are energized later. This method is widely used in earthed-neutral systems but cannot be applied when the neutral is isolated, since, in this case, closing one pole of a three-phase breaker applies no voltage to any transformer winding.

A controlled switching method for isolated neutral systems has been described in [16]. This method is based on prospective and residual fluxes computed from phase-to-phase voltages, but it does not provide an analytical expression of the proper closing instants. In this paper, optimal switching instants are determined analytically based on the solution of a min-max problem in order to minimize flux asymmetry during transformer energization.

* Corresponding author. Tel.: +34 954 455 2814; fax: +34 954556218.

E-mail addresses: ramoncano@us.es (R. Cano-González), abslhm@us.es (A. Bachiller-Soler), rosendo@us.es (J.A. Rosendo-Macías), galvarez@ree.es (G. Álvarez-Cordero).

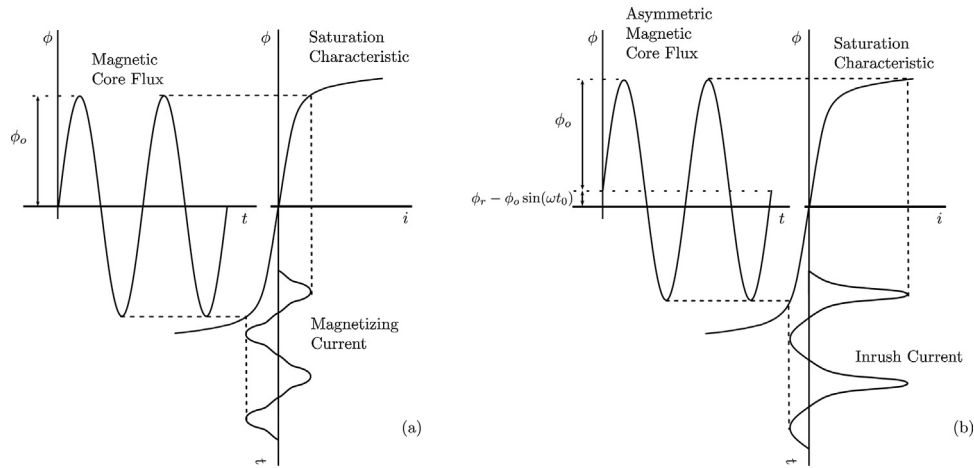

Fig. 1. Inrush current generated when flux exceeds saturation limit.

Furthermore, residual fluxes are computed from phase-to-ground voltage. The voltage signals needed by the controller for this process may be taken from Voltage Transformers (VTs) or Capacitor Voltage Transformers (CVTs) which are commonly installed adjacent to the transformer. This new approach achieves optimal mitigation of inrush current.

Section 2 focuses on the controlled switching principles to reduce inrush current. Section 3 describes the residual flux measurement in ungrounded transformers using phase-to-ground voltage. Section 4 describes the proposed controlled energization method, while Section 5 presents the simulation results which verify inrush current elimination during energization. The results of this paper are summarized in Section 6.

2. Controlled switching principles

Suppose a voltage $u(t) = U_o \cos(\omega t)$ is applied to an unloaded transformer at instant t_0 . It is well known that the core flux is the integral of the applied voltage and can be expressed as

$$\phi(t) = \phi_r + \frac{1}{N} \int_{t_0}^t u(\tau) d\tau = \phi_r - \phi_o \sin(\omega t_0) + \phi_o \sin(\omega t) \quad (1)$$

where $\phi_o = U_o / (N\omega)$ is the sinusoidal flux amplitude, and ϕ_r is the residual flux prior to instant t_0 . ϕ_r is a permanent magnetization of the core that remains due to hysteresis of the ferromagnetic material when the transformer is de-energized.

From (1), the maximum possible value of the flux $\phi(t)$ upon energization is $2\phi_o + \phi_r$. Power transformers are designed to operate at a rated voltage and flux close to the saturation knee point (Fig. 1a). The core enters deep saturation as soon as the core flux exceeds the rated value, resulting in a large magnetizing current (Fig. 1b).

Fig. 2 illustrates the basic principle for the elimination of the core flux asymmetry: the prospective flux (indefinite integral of the applied voltage) at the instant of energization must equal the residual flux. This is equivalent to selecting the energization instant t_0 such that $\phi_r = \phi_o \sin(\omega t_0)$, in accordance with (1).

3. Measurement of residual magnetic fluxes in ungrounded transformers

The residual fluxes can be obtained by integrating the corresponding phase voltages during de-energization, in accordance with Faraday’s law. For this purpose, the three voltages between the lines and the transformer neutral point are required. For economic reasons, the neutral may not be located outside the tank, thereby

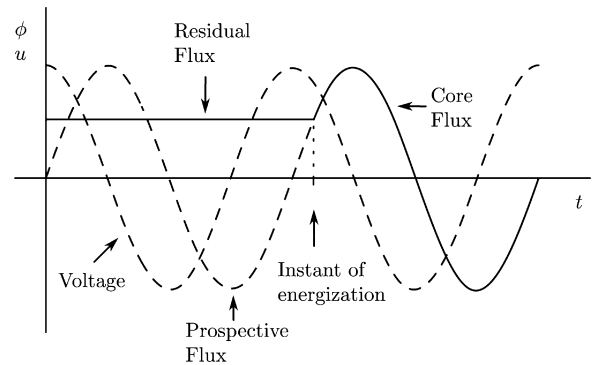

Fig. 2. Optimal energization to eliminate core flux asymmetry.

saving the cost of a bushing. Therefore, the transformer neutral point is occasionally inaccessible. However, the phase voltages of the transformer can be obtained from the phase-to-ground voltages. Fig. 3 shows a simplified system to energize the ungrounded transformer. The following equations hold:

$$\begin{aligned} u_{AN} - u_{BN} &= u_{AG} - u_{BG} \\ u_{BN} - u_{CN} &= u_{BG} - u_{CG} \\ u_{CN} - u_{AN} &= u_{CG} - u_{AG} \end{aligned} \quad (2)$$

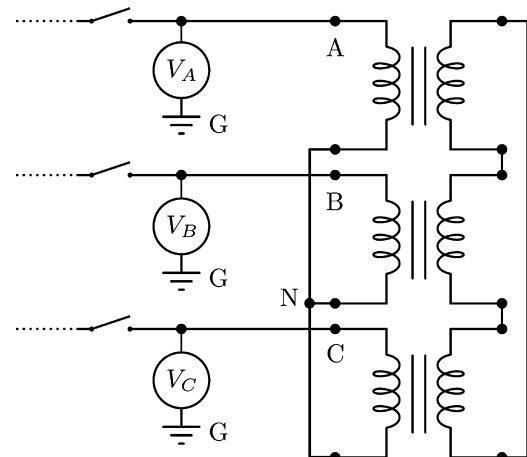

Fig. 3. Simplified system to energize the ungrounded transformer.

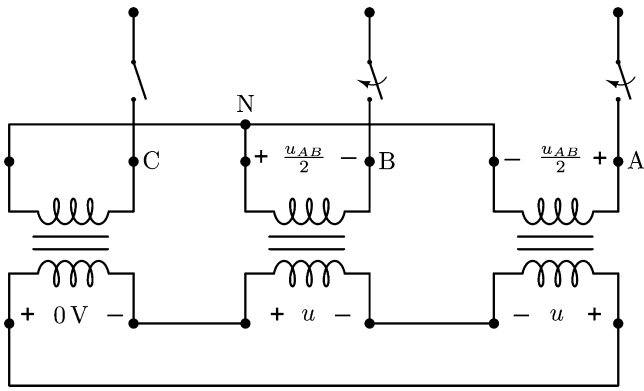

Fig. 4. Three-phase transformer, neutral point ungrounded.

Since the secondary winding is connected in delta:

$$u_{AN} + u_{BN} + u_{CN} = 0 \quad (3)$$

From Eqs. (2) and (3), the phase voltages of the transformer can be obtained:

$$\begin{aligned} u_{AN} &= \frac{1}{3}(2u_{AG} - u_{BG} - u_{CG}) \\ u_{BN} &= \frac{1}{3}(2u_{BG} - u_{CG} - u_{AG}) \\ u_{CN} &= \frac{1}{3}(2u_{CG} - u_{AG} - u_{BG}) \end{aligned} \quad (4)$$

Finally, the respective fluxes $\phi_A(t)$, $\phi_B(t)$, and $\phi_C(t)$ can be obtained by integrating the corresponding phase voltages of the transformer.

4. Proposed method

In this section, a controlled energization method for a three-phase transformer with isolated neutral is described. The method can be applied to three-phase transformers energized from a wye winding connection where the sum of the three winding fluxes is equal to zero, that is, three-legged-core transformers or transformers with a delta connection in another winding.

Initially, for clarity, the proposed method is presented under the assumption that residual fluxes present a symmetric pattern (+R, -R, 0), with near zero residual flux in one phase, and a plus finite value and a minus finite value in the other two phases. This pattern can be forced, or at least closely approximated, by properly controlled de-energization [14,17,18].

The method is then extended to include any residual flux pattern. In the case where there is an unplanned de-energization, e.g. a fault occurs, the sum of residual fluxes remains zero, but any pattern can be found in the magnetic core, R_1, R_2, R_3 , with $R_1 + R_2 + R_3 = 0$. In this situation, the method can be applied with minor modifications. Inrush current can be completely eliminated in both cases.

4.1. Switching method with residual flux pattern +R, -R, 0

Fig. 4 shows the electrical schema of a Y-Δ three-phase transformer to illustrate the method.

The phase notation in this work will assume that the residual fluxes are $\phi_{Ar}=R, \phi_{Br}=-R, \phi_{Cr}=0$, although this method could easily be adapted to other cases.

First, the method proposes energizing the two phases with residual fluxes +R and -R, i.e., A and B phases, at the time instant t_0 , when the prospective fluxes $\phi_{Ap}(t_0)$ and $\phi_{Bp}(t_0)$ are equal to the residual fluxes, $\phi_{Ap}(t_0)=R$ and $\phi_{Bp}(t_0)=-R$.

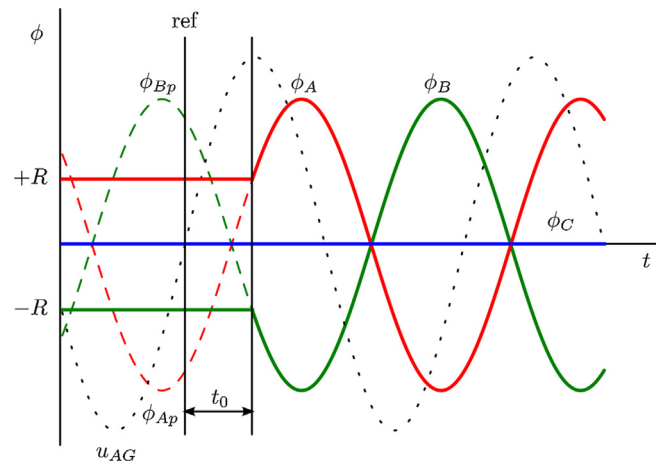

Fig. 5. Actual (solid lines) and prospective (dash lines) core fluxes for the switching of phases A and B at t_0 . Symmetric pattern case.

For $t > t_0$, $u_{AN}(t) = -u_{BN}(t) = u_{AB}(t)/2$, and $u_{CN}(t) = 0$, and the corresponding fluxes have the same relationships as the voltages, i.e., $\phi_A(t) = -\phi_B(t)$, $\phi_C(t) = 0$.

Fig. 5 illustrates the actual fluxes (solid lines) and the prospective fluxes (dashed lines), as well as the phase-A-to-ground voltage, u_{AG} , as a time reference. Note that when $t < t_0$, the actual core fluxes are residual fluxes, but when $t > t_0$, the three fluxes follow the corresponding prospective fluxes (phase C remains zero).

By using the zero crossing of voltage u_{AG} with positive derivative as reference, the first possible switching time, t_0 , is obtained by

$$t_0 = \frac{\arcsin(2R/\sqrt{3}\phi_0) + \pi/3}{2\pi f} \quad (5)$$

Where:

$$\phi_0 = \frac{U}{4.44nf} \quad (6)$$

is the flux peak value when the nominal phase-to-neutral voltage, with the rms value given by U , is applied to a transformer winding; f is the network frequency; and n is the number of winding turns.

Finally, the method proposes closing the third pole at instant t_1 , when the actual fluxes, after the closing at t_0 , match all three new prospective fluxes corresponding to the balanced system,

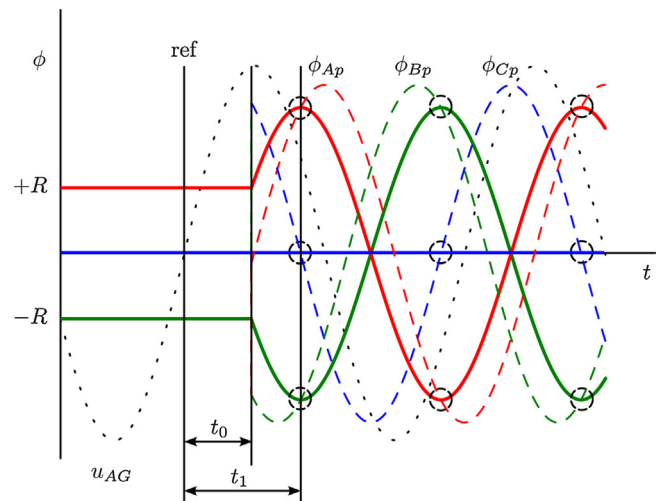

Fig. 6. Optimal closing instant for phase C. Symmetric pattern case. Actual fluxes (solid lines) and prospective fluxes (dash lines).

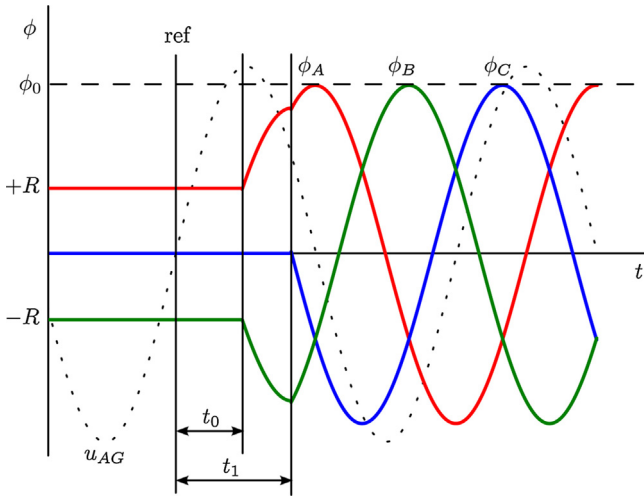

Fig. 7. Fluxes during the whole energization process. Symmetric pattern case.

as illustrated in Fig. 6, that is, $\phi_{Ap}(t_1)=\phi_A(t_1)$, $\phi_{Bp}(t_1)=\phi_B(t_1)$, $\phi_{Cp}(t_1)=\phi_C(t_1)=0$.

The method takes advantage of the fact that all three equations are simultaneously satisfied at the zero crossings of $\phi_{Cp}(t)$, i.e., twice per cycle, as marked by circles in Fig. 6. The solution is found by means of

$$t_1 = \frac{\arcsin(\phi_{Cr}/\phi_0) - \pi/6}{2\pi f} \quad (7)$$

By taking into consideration that $\phi_{Cr}=0$, then the first positive solution is $t_1=T/2 - T/12=5T/12$, where $T=1/f$ is the wave period.

The whole energization process is shown in Fig. 7, where the first two phases are energized at t_0 and the third phase at t_1 . It can be seen that the fluxes do not exceed their nominal amplitudes, ϕ_0 , at any time, and therefore have no core saturation, thereby achieving optimal inrush-current mitigation.

4.2. Switching method with asymmetric residual fluxes

If the symmetric pattern of the residual fluxes $+R, -R, 0$ cannot be obtained during de-energization, then certain changes must be made to generalize the method. In order to describe the energization process more clearly, it is assumed that $\phi_{Ar}=R_1$, $\phi_{Br}=R_2$, $\phi_{Cr}=R_3$ with $|R_1|, |R_2| \geq |R_3|$ and $R_1 > 0$.

As in the previous case, the two phases with the highest residual flux are the first to close, but now the prospective fluxes $\phi_{Ap}(t)$ and $\phi_{Bp}(t)$ do not match the residual fluxes ϕ_{Ar} and ϕ_{Br} at any instant. However, there is an optimal instant t_0 that can be found as the solution of the following min–max problem.

$$\min_{\omega t \in [0, 2\pi]} \max \{ |\phi_{Ap}(t) - R_1|, |\phi_{Bp}(t) - R_2| \} \quad (8)$$

As Fig. 8 shows, the min–max problem in (8) has two solutions per period, shown here using circles, where the greatest difference between the residual and prospective fluxes of the two phases is at its minimum. Graphically, it can be observed that solutions occur when $|\phi_{Ap}(t_0) - R_1| = |\phi_{Bp}(t_0) - R_2|$ and the instant t_0 can be analytically found by means of

$$t_0 = \frac{\arcsin(R_1 - R_2/\sqrt{3}\phi_0) + \pi/3}{2\pi f} \quad (9)$$

Fig. 9 shows actual and prospective fluxes after energization phases A and B. As can be observed, at $t=t_0$ the residual fluxes of phases A and B are not equal to the corresponding prospective fluxes. However, the difference is the minimum that can be obtained.

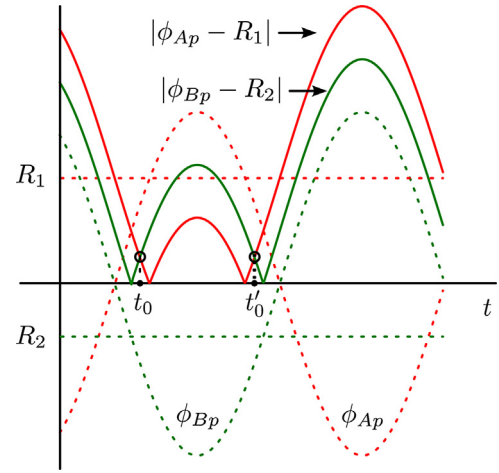

Fig. 8. Optimal close instant as solution of min–max problem.

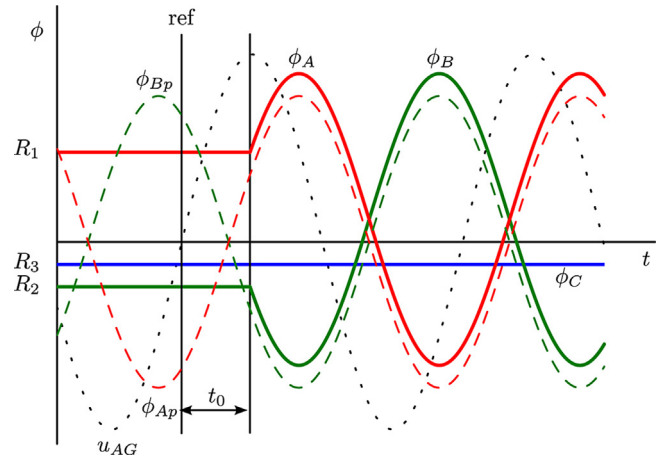

Fig. 9. Actual (solid lines) and prospective (dash lines) core fluxes for the switching of phases A and B at t_0 . Asymmetric pattern case.

In Fig. 10, it can be observed that, after the closing at t_0 , the actual fluxes (solid lines) match all three new prospective fluxes (dashed lines), corresponding to the balanced system, twice per cycle. The third pole, phase C, can be closed at t_1 , when residual

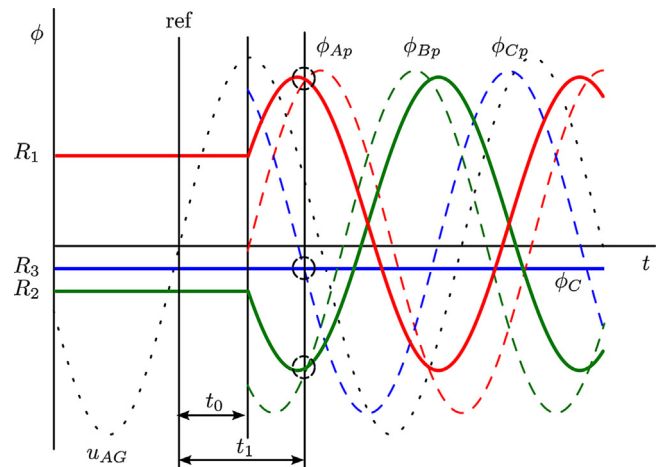

Fig. 10. Actual (solid lines) and prospective (dash lines) core fluxes for the switching of phase C at t_1 . Asymmetric pattern case.

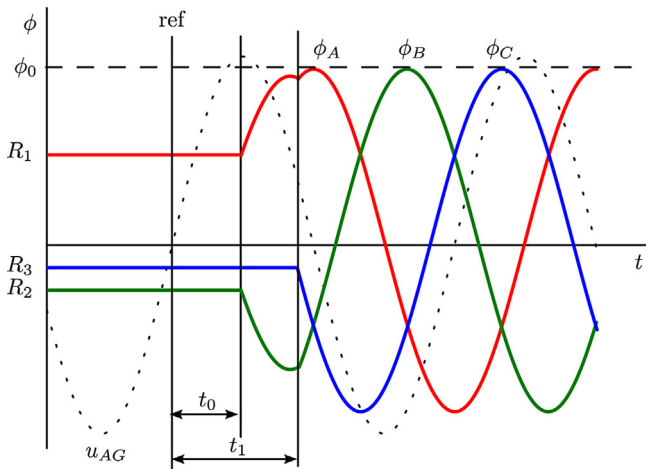

Fig. 11. Fluxes during the whole energization process. Asymmetric pattern case.

fluxes match prospective fluxes $\phi_{Ap}(t_1)=\phi_A(t_1)$, $\phi_{Bp}(t_1)=\phi_B(t_1)$ and $\phi_{Cp}(t_1)=\phi_C(t_1)=R_3$. The value of instant t_1 can be obtained by

$$t_1 = \frac{\arcsin(R_3/\phi_0) - \pi/6}{2\pi f} \quad (10)$$

Following the method shown, core fluxes after complete energization are equal to fluxes in the steady-state balanced system, see Fig. 11.

In the interval between t_0 and t_1 , magnetic fluxes have a small DC component, but the flux rate value ϕ_0 is not exceeded since the voltage applied to the transformer winding is lower than the rated value. Therefore, the transformer core is not driven into saturation during energization and inrush current is reduced to the unloaded magnetizing current.

If the presented methods for energizing the transformer, with symmetric and asymmetric patterns of residual fluxes, are analyzed, it is easy to see that the former is merely a particular case of the latter. Hence, only one algorithm has to be programmed into the controlled switching device. The pseudo-code of the proposed algorithm is as follows:

1. Measure the phase-to-ground voltages during de-energization.
2. Calculate the phase voltages of the transformer according to (4).
3. Calculate the residual fluxes by integrating the corresponding phase voltages.
4. Close the two phases with highest residual flux at the instant given by (9).
5. Close the third phase when its residual and prospective fluxes are equal, whose instant is given by (10).

5. Simulation of ungrounded transformer switching

A number of simulations were conducted using the electro-magnetic transient program ATP/EMTP to verify the proposed strategy. The test system employed to carry out the simulations, shown in Fig. 12, is composed of a 220 kV, 50Hz voltage source and a 160 MVA, 220/70.9/24 kV, three-legged-core transformer connected in Yyd. The transformer has been modeled using the Hybrid transformer model, whose parameters have been obtained from standard test data provided by the manufacturer. The Hybrid transformer model can give an accurate representation of the transformer cores [19–21].

Random energization of this transformer may produce core saturation and large dynamic fluxes. This saturation results in high magnitude currents, as can be observed in Fig. 13.

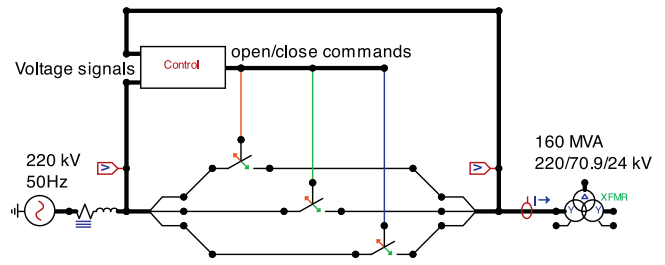

Fig. 12. ATPDraw circuit for system simulation.

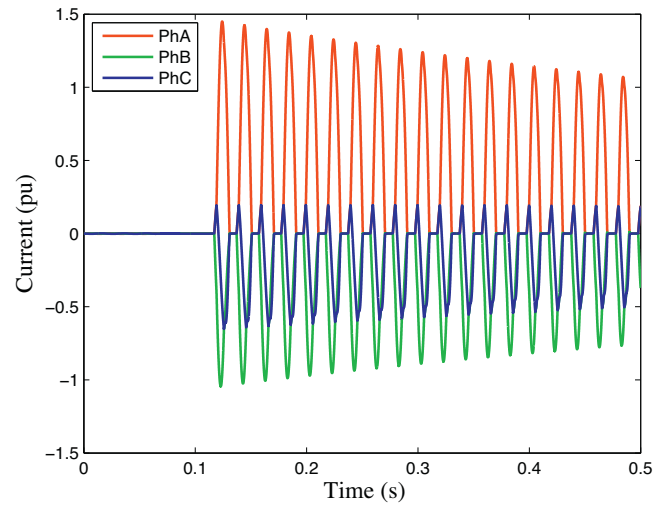

Fig. 13. Inrush current during uncontrolled energization.

Inrush current can be eliminated through the control of transformer energization by the proposed method. During de-energization, the residual fluxes were calculated by integrating the corresponding phase voltages from (4), yielding, in this case, $\phi_{Ar}=0.56\text{pu}$, $\phi_{Br}=-0.22\text{pu}$, and $\phi_{Cr}=-0.34\text{pu}$ (Fig. 14).

Fig. 14 shows core flux evolution during energization following the method described in the previous section. The two phases with the highest residual flux, phases A and C, are closed at instant t_0 , given by (9). Phase B is closed when its prospective flux is equal to its residual flux ϕ_{Br} at instant t_1 , given by (10).

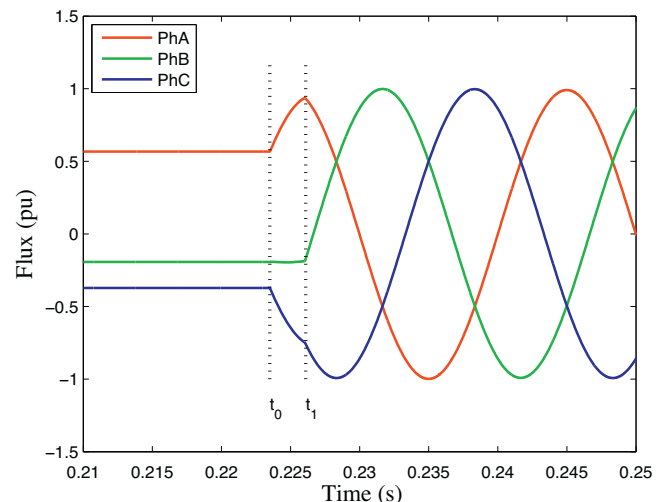

Fig. 14. Core fluxes during energization.

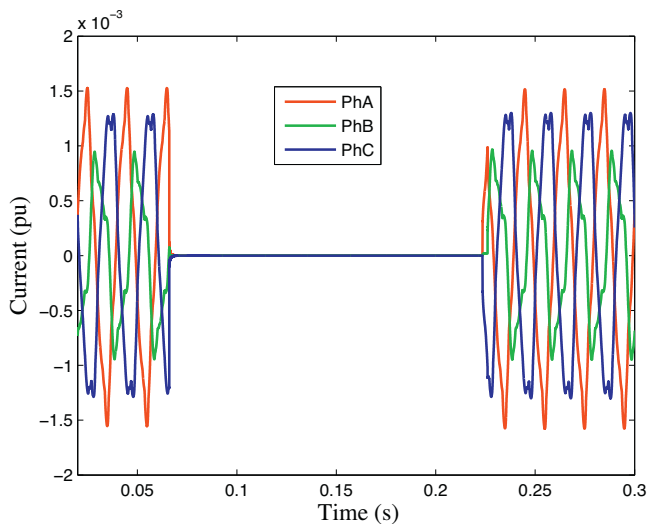

Fig. 15. Currents during de-energization and energization process.

Since the flux does not exceed the rated value, the saturation phenomenon does not appear in magnetic core and the current during energization is the same as the unloaded transformer magnetizing current in steady state, as illustrated in Fig. 15.

6. Conclusions

In this work, a method has been proposed for inrush current mitigation of three-phase transformers with isolated neutral for controlled switching. The method requires independent-pole-operated circuit breakers and phase-to-ground voltage measurement for the determination of the residual flux. Two switching operations are required: the first energizes the phases with higher residual flux; the second operation energizes the third phase. Optimal switching instants are analytically obtained: the first instant, t_0 , as a function of the residual fluxes; and the second instant, t_1 , at a later time instant where all the actual fluxes perfectly and simultaneously match their prospective fluxes, thereby providing optimal inrush current mitigation.

In order to verify the feasibility and performance of the proposed method, an experimental prototype is being developed. The authors intend to report the results in a future paper.

Acknowledgement

The authors would like to acknowledge the financial support of Red Eléctrica de España (Spanish TSO) under grant PI-0939/2012.

References

- [1] J.H. Brunke, K.J. Frohlich, Elimination of transformer inrush currents by controlled switching. Part I. Theoretical considerations, *IEEE Trans. Power Deliv.* 16 (2) (2001) 276–280.
- [2] A. Hosny, V.K. Sood, Transformer differential protection with phase angle difference based inrush restraint, *Electr. Power Syst. Res.* 115 (0) (2014) 57–64, <http://dx.doi.org/10.1016/j.epsr.2014.03.027>, special issue based on selected expanded contributions from the 10th International Conference on Power System Transients (IPST).
- [3] R. Hamilton, Analysis of transformer inrush current and comparison of harmonic restraint methods in transformer protection, *IEEE Trans. Ind. Appl.* 49 (4) (2013) 1890–1899.
- [4] M. Steurer, K. Frohlich, The impact of inrush currents on the mechanical stress of high voltage power transformer coils, *IEEE Trans. Power Deliv.* 17 (1) (2002) 155–160.
- [5] W. Neves, D. Fernandes, F.J.A. Baltar, A.J.P. Rosentino, E. Saraiva, A.C. Delaiba, R. Guimaraes, M. Lynce, J.C.D. Oliveira, A comparative investigation of electromechanical stresses on transformers caused by inrush and short-circuit currents, in: 11th International Conference on Electrical Power Quality and Utilisation (EPQU), 2011, pp. 1–6.
- [6] M. Nagpal, T.G. Martinich, A. Moshref, K. Morison, P. Kundur, Assessing and limiting impact of transformer inrush current on power quality, *IEEE Trans. Power Deliv.* 21 (2) (2006) 890–896.
- [7] L.F. Blume, G. Camilli, S.B. Farnham, H.A. Peterson, Transformer magnetizing inrush currents and influence on system operation, *Trans. Am. Inst. Electr. Eng.* 63 (6) (1944) 366–375.
- [8] J.C. Oliveira, C.E. Tavares, R. Apolonio, A.B. Vasconcellos, H.S. Bronzeado, Transformer controlled switching to eliminate inrush current - Part I: Theory and laboratory validation, in: Transmission and Distribution Conference and Exposition: Latin America, TDC'06, IEEE/PES, 2006, pp. 1–5.
- [9] H.-T. Tseng, J.-F. Chen, Bidirectional impedance-type transformer inrush current limiter, *Electr. Power Syst. Res.* 104 (0) (2013) 193–206, <http://dx.doi.org/10.1016/j.epsr.2013.06.007>.
- [10] A. Ketabi, A.R.H. Zavareh, New method for inrush current mitigation using series voltage-source pwm converter for three phase transformer, in: Power Electronics, Drive Systems and Technologies Conference (PEDSTC), 2011, pp. 501–506.
- [11] Y. Cui, S.G. Abdulsalam, S. Chen, W. Xu, A sequential phase energization technique for transformer inrush current reduction - Part I: Simulation and experimental results, *IEEE Trans. Power Deliv.* 20 (2) (2005) 943–949.
- [12] S.G. Abdulsalam, W. Xu, A sequential phase energization method for transformer inrush current reduction: Transient performance and practical considerations, *IEEE Trans. Power Deliv.* 22 (1) (2007) 208–216.
- [13] J.H. Brunke, K.J. Frohlich, Elimination of transformer inrush currents by controlled switching. Part II. Application and performance considerations, *IEEE Trans. Power Deliv.* 16 (2) (2001) 281–285.
- [14] L. Prikler, G. Bánfai, G. Bán, P. Becker, Reducing the magnetizing inrush current by means of controlled energization and de-energization of large power transformers, *Electr. Power Syst. Res.* 76 (8) (2006) 642–649, <http://dx.doi.org/10.1016/j.epsr.2005.12.022>, selected Topics in Power System Transients.
- [15] D. Goldsworthy, T. Roseburg, D. Tziouvaras, J. Pope, Controlled switching of HVAC circuit breakers: application examples and benefits, in: 2008 61st Annual Conference for Protective Relay Engineers, 2008, pp. 520–535, <http://dx.doi.org/10.1109/CPRE.2008.4515078>.
- [16] T. Koshizuka, H. Kusuyama, M. Saito, H. Maehara, Y. Sato, H. Toda, Controlled switching for energizing 3-phase transformers in isolated neutral system, in: Transmission and Distribution Conference and Exposition: Asia and Pacific, 2009, pp. 1–4.
- [17] A. Ebner, M. Bosch, R. Cortesi, Controlled switching of transformers - effects of closing time scatter and residual flux uncertainty, in: 43rd International UPEC 2008 Universities Power Engineering Conference, 2008, pp. 1–5.
- [18] N. Chiesa, B.A. Mork, H.K. Høidalen, Transformer model for inrush current calculations: simulations, measurements and sensitivity analysis, *IEEE Trans. Power Deliv.* 25 (4) (2010) 2599–2608.
- [19] B.A. Mork, F. Gonzalez, D. Ishchenko, D.L. Stuehm, J. Mitra, Hybrid transformer model for transient simulation - Part I: Development and parameters, *IEEE Trans. Power Deliv.* 22 (1) (2007) 248–255.
- [20] B.A. Mork, F. Gonzalez, D. Ishchenko, D.L. Stuehm, J. Mitra, Hybrid transformer model for transient simulation-Part II: Laboratory measurements and benchmarking, *IEEE Trans. Power Deliv.* 22 (1) (2007) 256–262.
- [21] H.K. Høidalen, B.A. Mork, F. Gonzalez, D. Ishchenko, N. Chiesa, Implementation and verification of the hybrid transformer model in ATPDraw, *Electr. Power Syst. Res.* 79 (3) (2009) 454–459, <http://dx.doi.org/10.1016/j.epsr.2008.09.003>, special Issue: Papers from the 7th International Conference on Power Systems Transients (IPST).