



King Saud University  
**Journal of King Saud University – Engineering Sciences**

www.ksu.edu.sa  
 www.sciencedirect.com



## ORIGINAL ARTICLES

# Evaluation of V–t characteristics caused by lightning strokes at different locations along transmission lines

Mohammed Qais\*, Usama Khaled<sup>1</sup>

*Electrical Engineering Department, College of Engineering, King Saud University, Saudi Arabia*

Received 30 December 2015; accepted 17 February 2016

## KEYWORDS

Transmission lines;  
 Sag;  
 Lightning;  
 PSCAD;  
 Back flashover;  
 Arrester

**Abstract** Lightning stroke causes a current injection into transmission lines at the point of contact. The lightning performance can be difficult to understand without using simulation programs. PSCAD a powerful software was selected to develop the appropriate data required to investigate this phenomena.

In this paper, two points along transmission line are selected for studying voltage–time (V–t) characteristics when any of those points is subjected to lightning strokes separately. The first assumed point is taken when lightning current is injected to the shielding wire at the top of the transmission tower, while, the other assumed point is taken when surge current is injected to the shielding wire at maximum sag location in the mid-span between two towers. The sag of transmission line has been newly developed and simulated using PSCAD.

Both transmission line containing sag as well as lightning injection current are modeled. Fast transient of flashover as well as back flashover occurrence is investigated. The results revealed that the sag of transmission line has considerable influence on flashover and induced voltages across line insulators and phase lines as well. The influence of connecting surge arrester in substations is investigated. A proper transmission line arrester (TLA) is designed in order to minimize the occurrences of overvoltages due to flashover and consequently back flashover across insulators.

© 2016 The Authors. Production and hosting by Elsevier B.V. on behalf of King Saud University. This is an open access article under the CC BY-NC-ND license (<http://creativecommons.org/licenses/by-nc-nd/4.0/>).

\* Corresponding author.

E-mail addresses: [mqais@ksu.edu.sa](mailto:mqais@ksu.edu.sa) (M. Qais), [ukhaled@ksu.edu.sa](mailto:ukhaled@ksu.edu.sa) (U. Khaled).

<sup>1</sup> On leave: Faculty of Energy Engineering, Aswan University, Egypt.

Peer review under responsibility of King Saud University.



Production and hosting by Elsevier

## 1. Introduction

One of the natural sources of transient overvoltage in the power system is lightning strokes. Lightning stroke is an impulsive transient variation which is unidirectional in polarity (positive or negative). Overhead transmission line is the most part subjected to the lightning phenomena. Transmission lines are protected from the direct lightning by shield wires. The lightning current injection to shield wires or tower body will

<http://dx.doi.org/10.1016/j.jksues.2016.02.003>

1018-3639 © 2016 The Authors. Production and hosting by Elsevier B.V. on behalf of King Saud University.

This is an open access article under the CC BY-NC-ND license (<http://creativecommons.org/licenses/by-nc-nd/4.0/>).

Please cite this article in press as: Qais, M., Khaled, U. Evaluation of V–t characteristics caused by lightning strokes at different locations along transmission lines. Journal of King Saud University – Engineering Sciences (2016), <http://dx.doi.org/10.1016/j.jksues.2016.02.003>

cause induced voltage across insulators and phase lines (Bollen et al., 2005).

In previous works, most researchers had studied several parameters that affect the lightning performance on transmission system. The common parameters of lightning are: front time, tail time, peak lightning current, tower geometry, footing resistance, corona, flashover, etc (Chowdhuri, 2001; Talib et al., 2012; Yadee and Prem, 2007).

In addition, the striking distance of lightning stroke is a very important parameter to study the performance of lightning on transmission system (Mazur and Ruhnke, 2003).

The mountainous places are mostly subjected to the lightning phenomena where the striking distances are small and the resistivity of rocky mountainous soil is very high.

This paper presents a prediction of V-t characteristics when a simulated lightning current injected at the top of transmission tower or at the maximum sag location of 500 kV overhead transmission line with and without using surge arresters. The induced voltages across insulator as well as in the phase conductors resulting from lightning strikes hitting the ground wires at sag locations are investigated. The obtained results report that the sag of transmission line has an obvious effect not only on V-t characteristics of phase conductors but also on line insulators when surge lightning hits the shielding wire. This study could be useful for predicting and improving transient overvoltage protection system.

## 2. Modeling of 500 kV transmission system

### 2.1. Tower module

Tower type and geometry used in this work is shown in Fig. 1. This type of tower can be modeled in PSCAD by representing main legs and cross arms with its equivalent surge impedances and propagation velocity. The surge impedance for each part of tower is  $200 \Omega$  and the propagation velocity is  $2.5 \times 10^8$  m/s. Each part of tower is modeled as transmission line model consisting of Bergeron model and manual entry of surge impedance  $Z_0$ , propagation velocity and length (Martinez-Velasco and Castro-Aranda, 2005; Zakaria et al., 2002) as shown in Fig. 2. Line conductor radius is 15.3 mm and its assumed dc resistance is  $0.0511 \Omega/\text{km}$ , while ground conductor radius is 5.6 mm and its assumed dc resistance is  $0.564 \Omega/\text{km}$ .

### 2.2. Footing resistance

Generally there are two types of footing resistance models that can be used: one is simplified constant resistance model, the other model is dependent on surge current magnitude and soil ionization (Yadee and Prem, 2007; Sun and Tremouille, 2012).

In this paper, the footing resistance is kept constant and the effect of soil resistivity is considered. The footing resistance value is taken as  $80 \Omega$ .

### 2.3. Insulator module

The equivalent capacitance of insulator can be used to simplify the modeling of insulator in PSCAD. The insulator (cap and pin) equivalent capacitance is assumed to be  $100 \text{ pF}$ . It is

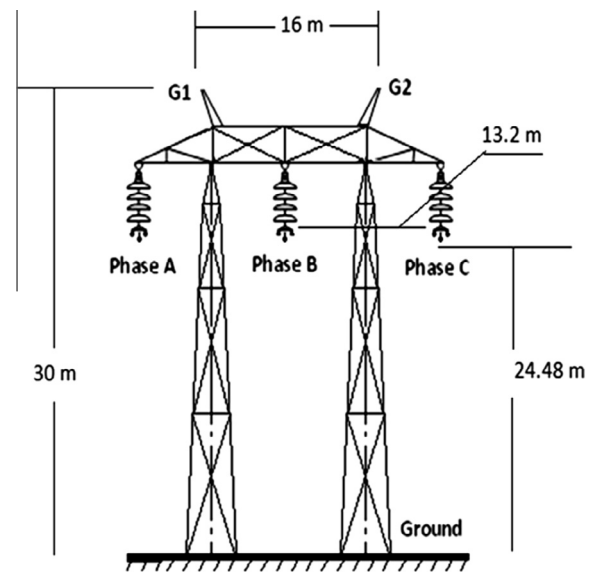

Figure 1 Typical configuration of 500 kV transmission tower.

assumed that the 500 kV insulator consists of 26 disks, having a total equivalent capacitance of  $3.94 \text{ pF}$ .

### 2.4. Back flashover module

Flashover occurs due to increase in the voltage across insulators. This voltage across insulators is increased due to the injection of lightning current into the top of the tower or the shield wires. If the voltage at the top of tower exceeds the insulator withstand voltage level, then a back flashover occurs (Sun and Tremouille, 2012).

Two models are recommended by IEC 60071-4 to represent the back flashover: critical flashover voltage (CFO) model and volt-time curve flashover model. In this work the volt-time characteristic model is used as follows:

$$V_{f0} = 400l + \frac{710l}{t^{0.75}} \quad (1)$$

where  $V_{f0}$  is flashover voltage in (kV),  $l$  is the length of insulator in (m) and  $t$  is time in ( $\mu\text{s}$ ).

The back flashover is represented by parallel switch across the insulator as shown in Fig. 3. The parallel switch is modeled and controlled by comparing the volt-time characteristics in (1) with the induced voltage across the insulator as shown in Fig. 4.

### 2.5. Surge arrester module

Surge arrester is a protective device used for limiting overvoltage on power system by discharging surge current to ground. IEEE had developed a model in which the non-linear V-I characteristic is represented by two sections of non-linear resistances designated by A0 and A1. These non-linear resistances are separated by an R-L filter as in Fig. 5.

For fast front surges, the impedance of the R-L filter becomes more significant (IEEE working groups, 1992).

For 500 kV transmission system, the maximum line to line voltage with 10% regulation becomes  $500 \times 1.1 = 550 \text{ kV}$ . The

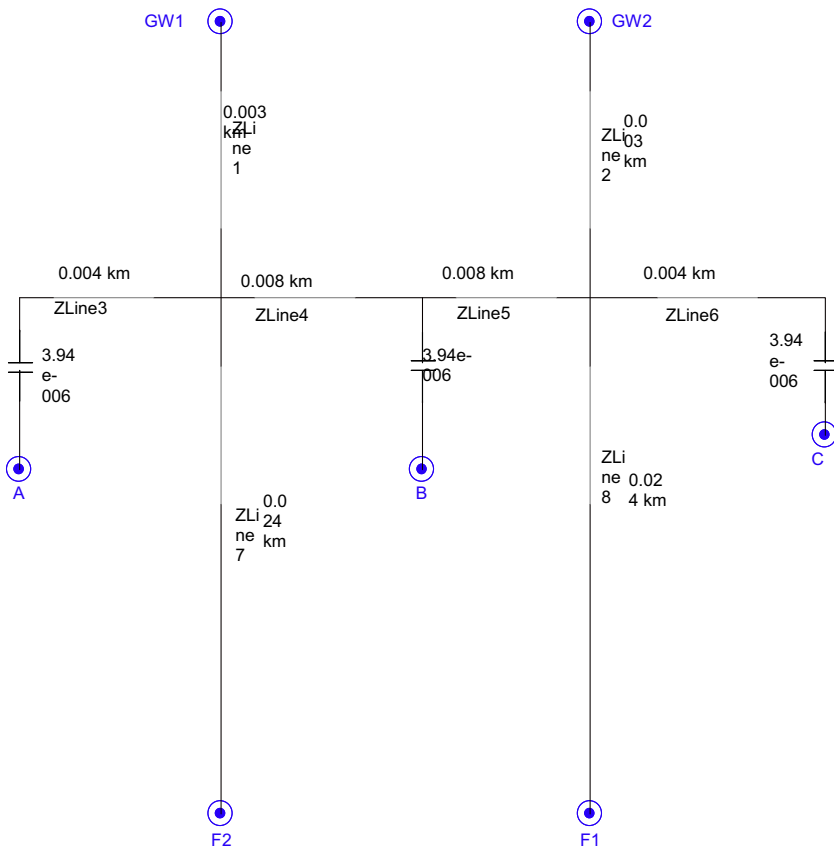

Figure 2 Equivalent PSCAD model of tower.

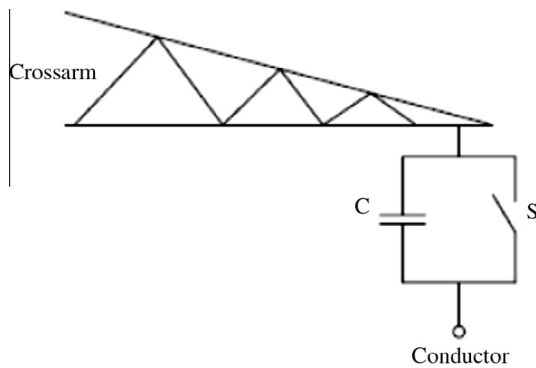

Figure 3 Equivalent circuit of insulator string and flashover.

line to ground maximum continuous operating voltage MCOV is  $(550)/\sqrt{3} = 317.54 \approx 318$  kV. The rated voltage of arresters is  $318 * 1.05 * 1.25 = 417.375$  kV  $\approx 420$  kV/rms. The other components are assumed as  $L_1 = 21.75 \mu\text{H}$ ,  $L_0 = 0.29 \mu\text{H}$ ,  $R_1 = 94.25 \Omega$ ,  $R_0 = 145 \Omega$  and  $C = 68.97$  pF (Meister et al., 2011; Steinfeld et al., 2002; IEEE std c62.22, 2009).

2.6. Transmission line sag module

The transmission line sag effects or the clearance from the earth, as shown in Fig. 6, is important to study lightning phenomenon especially at mountainous locations. In order to

study this case, the sag of transmission line (400 m of span) is modeled by dividing span into three transmission lines: T1 (150 m), T2 (100 m), and T3 (150 m). T2 is the location of sag with proposed length of 100 m and modified dimensions to adapt the sag as shown in Fig. 7.

2.7. 500 kV transmission system module

The proposed 500 kV power system has been modeled and simulated using PSCAD as shown in Fig. 8. The earth resistance at the ends of shield wires is assumed as 350  $\Omega$ . The footing resistance is considered constant and taken as 80  $\Omega$ .

2.8. Transmission line arresters

Transmission line arrester (TLA) is a protective device used for limiting excessive overvoltage due to incident lightning on shielding wires by discharging surge current onto phase conductors through insulators. Thus, TLA is connected in parallel with insulators of transmission lines in order to reduce the hazards of insulator flashover during the lightning.

The selection of MCOV rating of TLA is different than in distribution or substation arrester. In the case of TLA, the main objective is only to protect insulators from the undesirable back flashover during lightning surges. In this case, the increase in MCOV rating more than that of substation arrester is more effective.

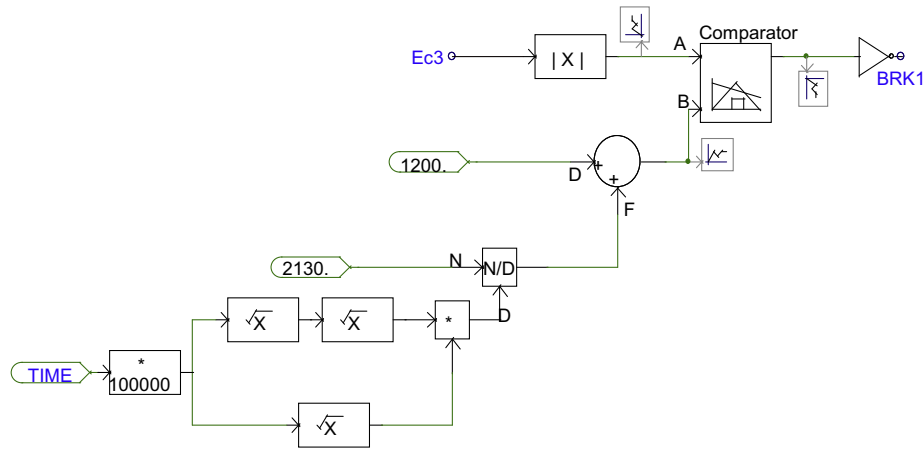

Figure 4 Controlling the parallel switch across the insulator in PSCAD.

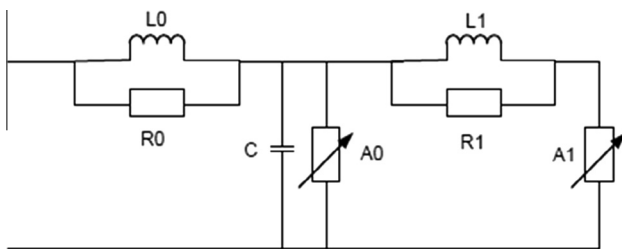

Figure 5 IEEE surge arrester model.

According to IEEE standard C62.22-1991 the duty cycle rating for surge arrester on 500 kV system ranges from 396 to 564 (kV/rms) (IEEE std C62.22, 1992). 560 kV/rms is taken in this work.

2.9. Lightning stroke module

The lightning stroke current is modeled according to (IEEE std C62.22, 1992):

$$i(t) = kI_p(e^{-\alpha t} - e^{-\beta t}) \tag{2}$$

where  $k$  is correction factor,  $I_p$  is peak current,  $\alpha$  and  $\beta$  are wave head and wave tail attenuation quotient of lightning, respectively.

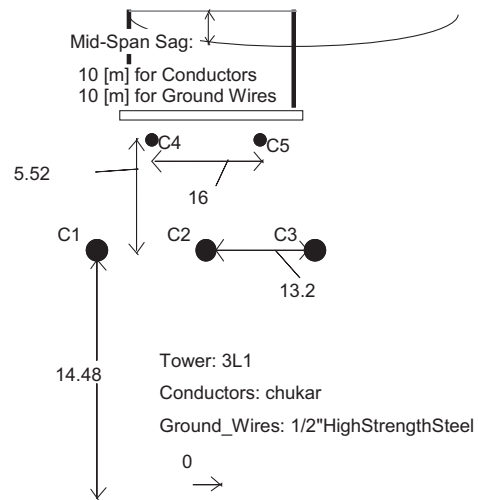

Figure 7 Modified dimensions used for sag location.

Lightning current injection is modeled as shown in Fig. 9, where  $k = 1.043$ ,  $\alpha = 14,730$ ,  $\beta = 2,080,000$  and  $I_p = 100$  kA.

Lightning impulse waveform with peak current 100 kA and 1.2/50  $\mu$ s is shown in Fig. 10. The lightning current is injected at the top of the tower and the sag location used as shown in Fig. 8.

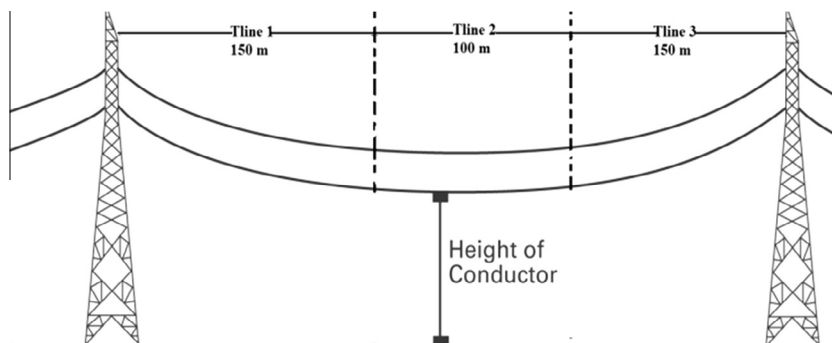

Figure 6 Representation of transmission line sag.

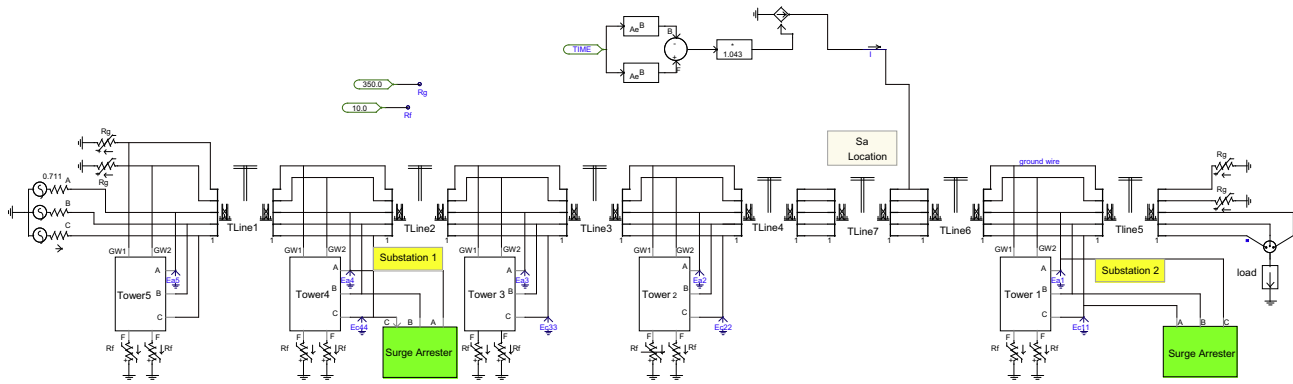

Figure 8 PSCAD model of 500 kV power transmission system.

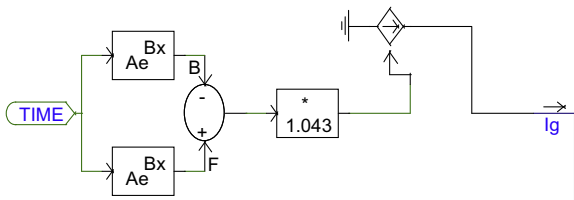

Figure 9 Lightning current modeling.

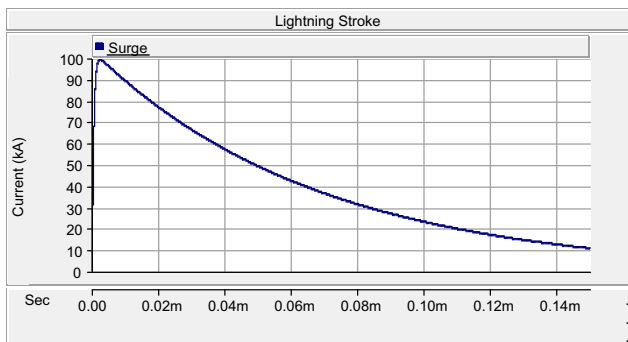

Figure 10 Lightning impulse waveform.

### 3. Results and discussion

The induced voltages, when lightning current is injected to the shielding wire at the top of transmission tower, is represented as lightning at zero sag location of transmission line. On the other hand, the induced voltage at maximum sag location is considered in the mid-span between two towers. Thus, comparing between the above two scenarios would be sufficient to clarify the effect of natural lightning performance along transmission lines on flashover and overvoltages on the phase lines and across insulators as well.

#### 3.1. Striking without substation arresters and without flashover

The V-t characteristics results shown in this study are for phase A and across its insulator. Similar trends are observed for overvoltage induced in phases B and C, as well.

##### 3.1.1. Lightning at top of tower

Lightning current is injected at the top of the tower 1 which will induce voltages in the line conductors and across the insulators. The induced voltages in phase (A) for different towers (Ea1, Ea2, Ea3, and Ea4) are shown in Fig. 11. The span between towers is 400 m. The maximum induced voltage occurred at the same stroked tower and will attenuate along the transmission line. The maximum induced voltage is 850 kV which is 2.08 times the peak voltage of line to ground voltage.

The induced voltages across the insulators at different towers Ec1, Ec2, Ec3, and Ec4 are shown in Fig. 12. The induced voltage at the stroked tower 1 exceeds 3000 kV and in the far-away towers is less than 1 MV so the chance of flashover occurrence is the highest at the stroked tower while there is no chance in the other towers.

##### 3.1.2. Lightning at sag location

For this simulation, the lightning current is injected to the sag location which is in the mid-span between the two towers 1 and 2. The induced voltages in phase conductors at different towers are shown in Fig. 13. The induced voltage in phase lines reaches 2000 kV which is 5 times the peak voltage of system and 2.35 times the induced voltage shown in Fig. 11.

The induced voltages across insulators at different towers due to lightning current injection into the sag location are shown in Fig. 14. The peak value of induced voltage in this case is about 4500 kV at both towers close to the sag. The maximum induced voltage measured at the other towers is 2000 kV. By comparing Figs. 12 and 14, it is clear that the risk of flashover occurrence is very high at all towers when the lightning hits the sag location.

### 3.2. Striking without substation arrester and with flashover

#### 3.2.1. Lightning at top of tower

If the induced voltage across the insulator due to the striking on the top of tower 1 is more than the volt-time characteristic of flashover voltage, then the back flashover will occur.

Fig. 15 shows the occurrence of back flashover when the induced voltage across the insulator intersects the volt-time characteristics of flashover voltage. Cascaded flashovers happen where the back flashover may result from increasing the induced voltage of phase lines.

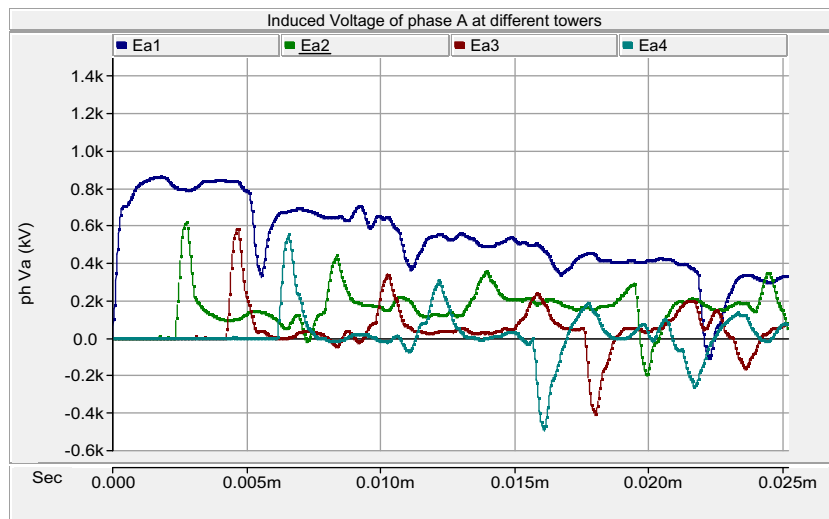

**Figure 11** Induced voltage of phase A at different towers.

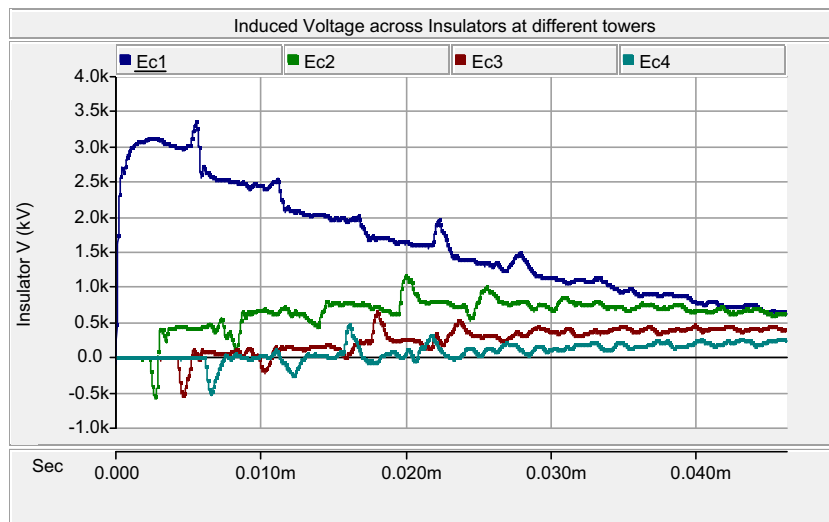

**Figure 12** Induced voltage across insulators at different towers.

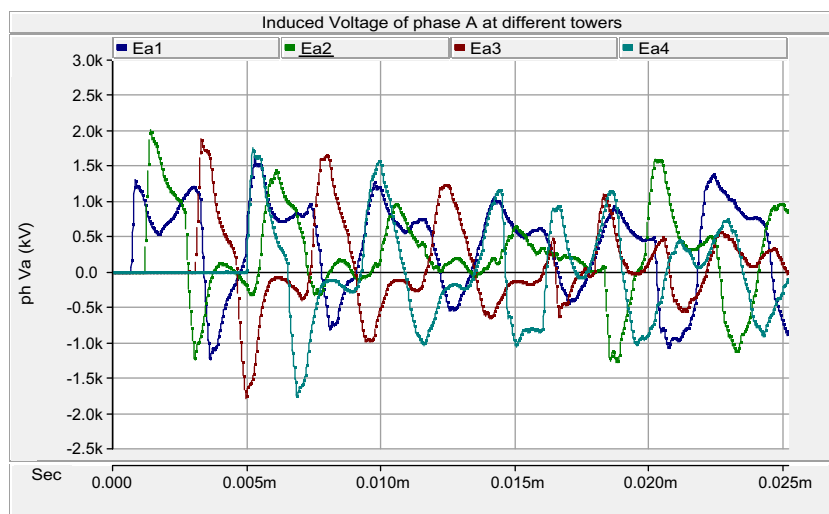

**Figure 13** Induced voltage of phase A when lightning hits sag location.

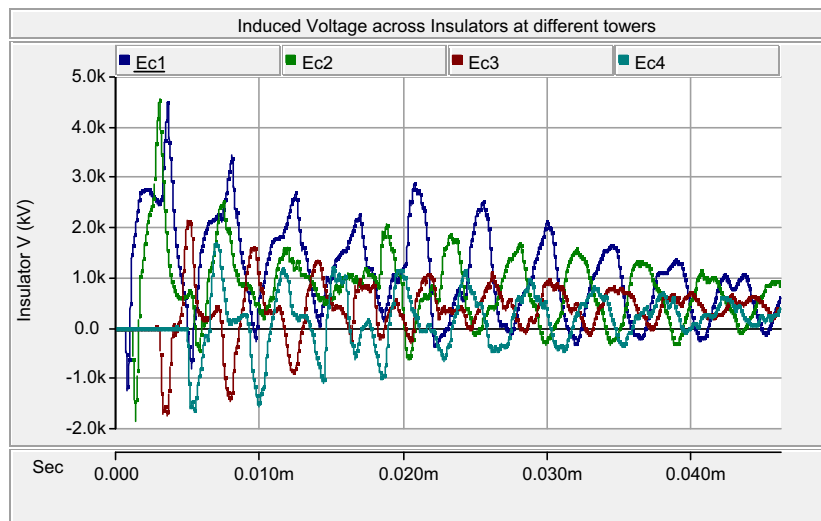

**Figure 14** Induced voltage across insulator when lightning hits sag location.

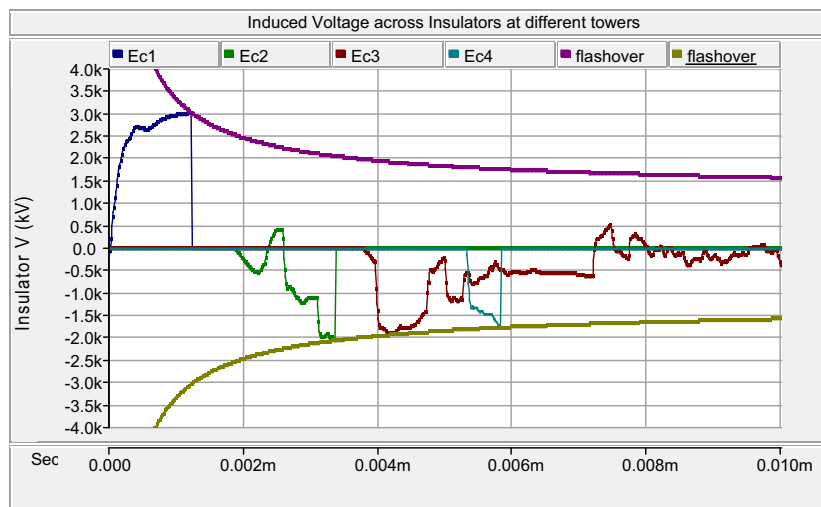

**Figure 15** Back flashover occurrence when induced voltage across insulator crosses volt-time characteristics.

Fig. 16 shows the induced voltage in phase A at different towers when the lightning current is injected at the top of tower 1.

### 3.2.2. Lightning at sag location

When the lightning current is injected to the mid-span (sag location) between towers 1 and 2, it causes cascaded back flashovers. Fig. 17 shows that the number of back flashover occurrences is more than in Fig. 15.

Fig. 18 shows the induced voltages in phase line A at different towers when lightning strikes the sag location and results in back flashover. It is obvious that the average peak of induced voltages at all towers is almost 1500 kV and the maximum peak voltage is almost of 3000 kV.

### 3.3. Striking with substation arrester and with flashover

In this section, the surge arresters are placed at substations 1 and 2 where the towers 1 and 4 are terminated. The lightning

performance with existence of substation arresters is simulated and studied.

#### 3.3.1. Lightning at top of tower

Fig. 19 shows that there is only back flashover at stroked tower 1. The substation arrester decreased the number of flashovers in this case.

Fig. 20 shows that the substation arrester reduced the peak values of induced voltage in phase A at different towers. Substation arresters have significant influence in the case of the lightning current injected at the top of tower 1.

#### 3.3.2. Lightning at sag location

In this case the lightning current is injected to the sag location between towers 1 and 2 and the substation arresters exist at substations 1 and 2.

Fig. 21 shows that a number of back flashover still occurs but are less than those shown in Fig. 17.



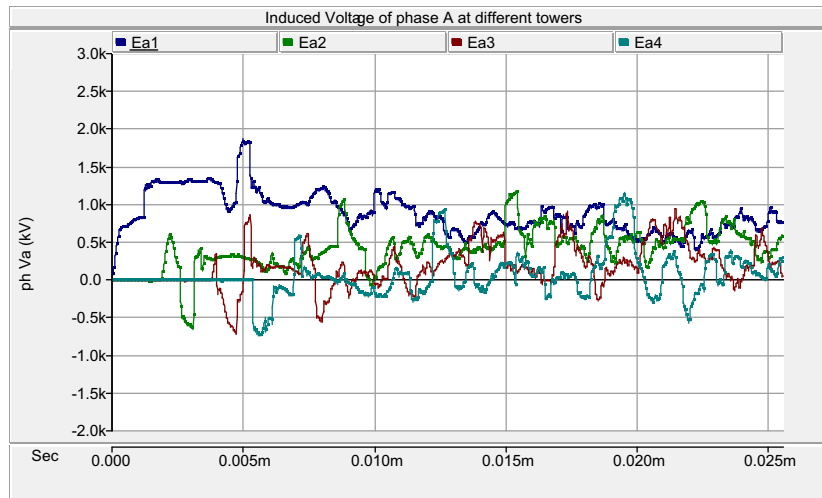

Figure 16 Induced voltage in phase A when striking top of tower 1.

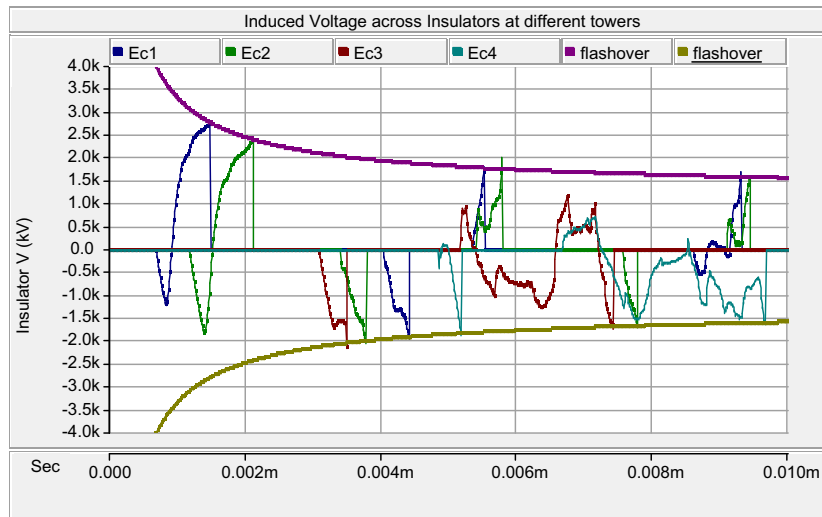

Figure 17 Back flashover and flashover across insulator of towers when striking the sag location.

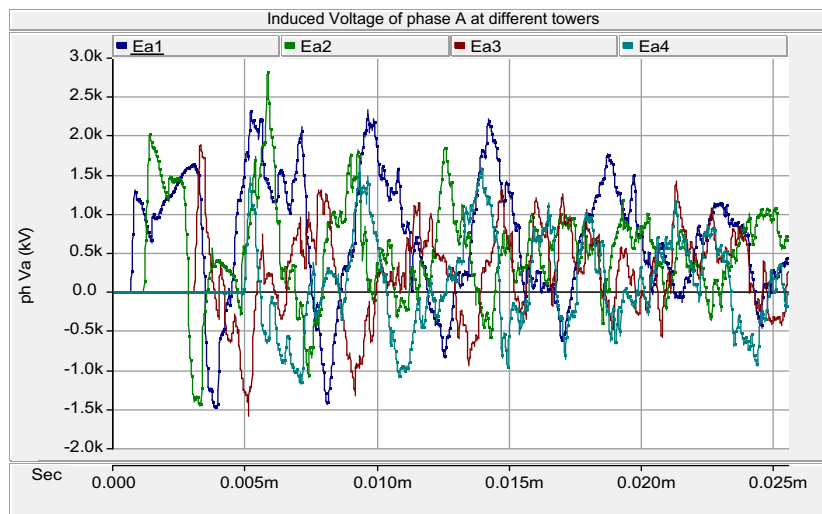

Figure 18 Induced voltage in line conductor A with flashover when stroke hits sag location.



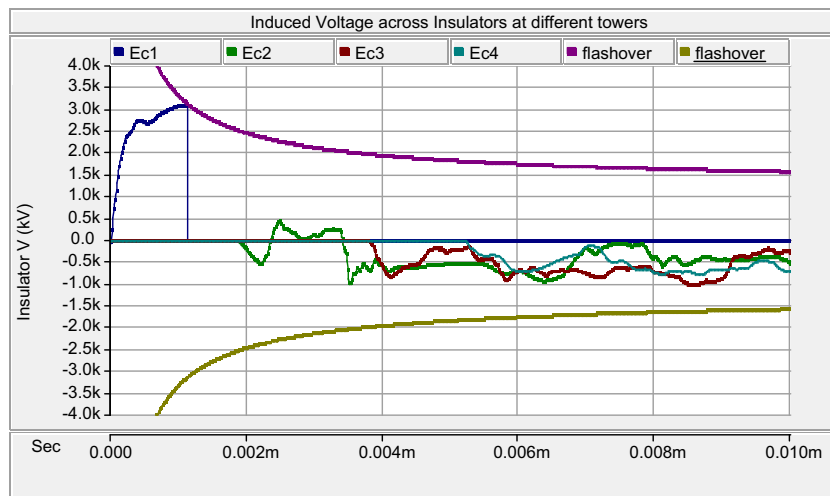

Figure 19 Induced voltage across insulators at different towers by connecting surge arresters at substations 1 and 2.

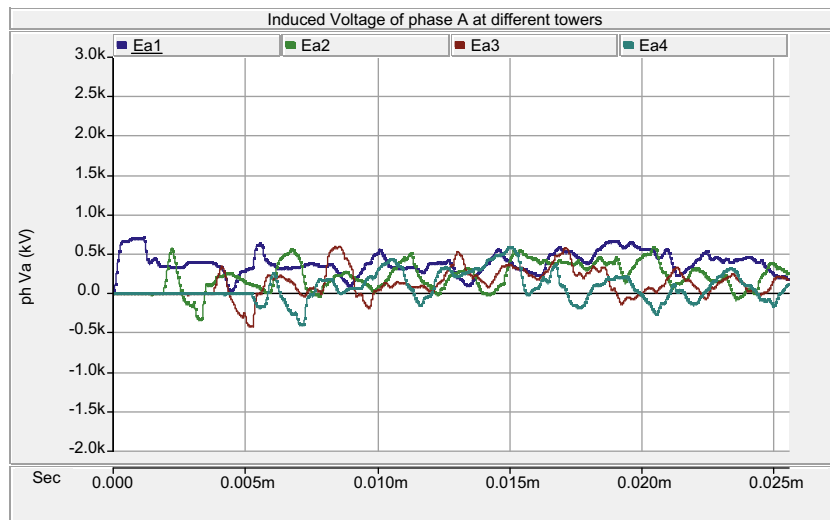

Figure 20 Induced voltage in phase A when striking top of tower 1 and with surge arrester connected to substations 1 and 2.

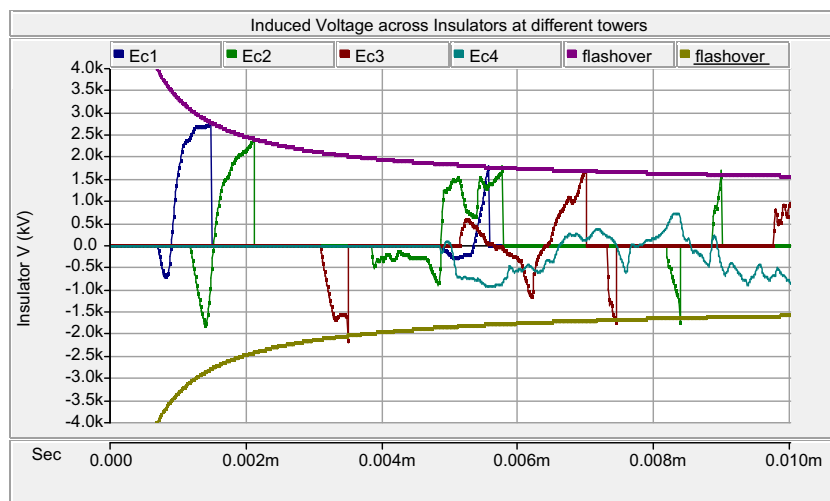
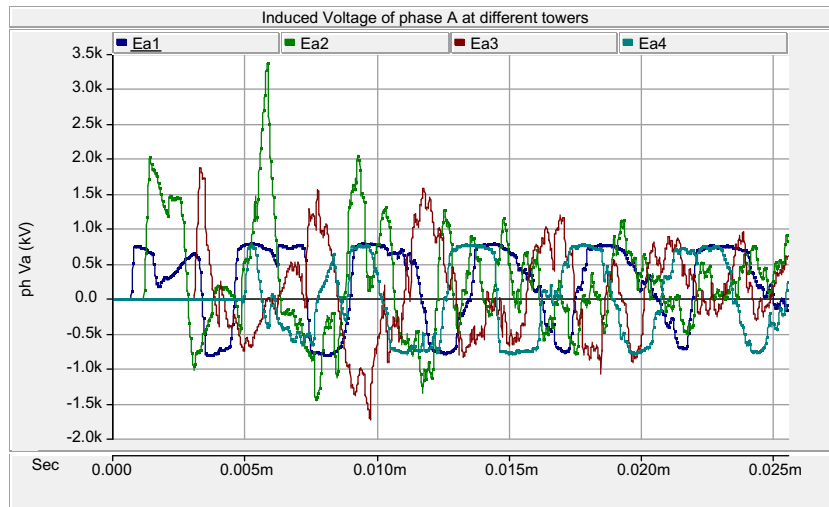
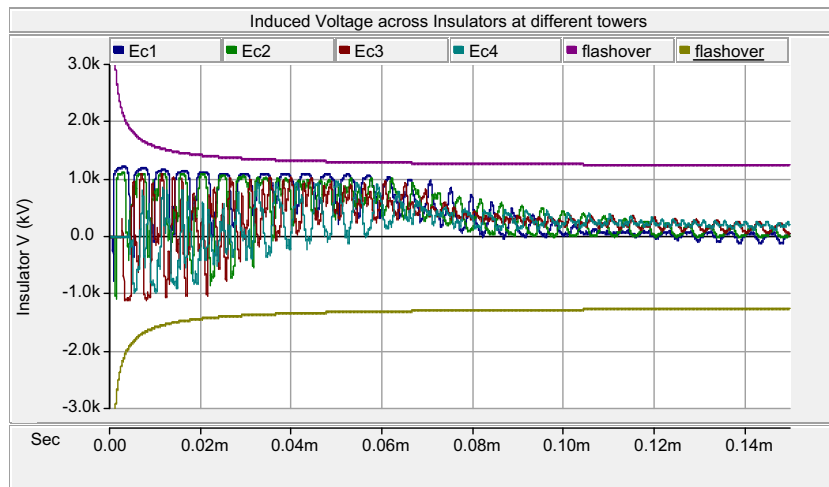

Figure 21 Induced voltage across insulators at different towers when lightning strikes sag location with the connecting of surge arresters at substations 1 and 2.



**Figure 22** Induced voltage in line conductor A when striking sag location and with surge arrester connected at substations 1 and 2.



**Figure 23** Induced voltage across insulator with the presence of TLA.

Fig. 22 shows that the induced voltages in phase A at substations are reduced. The induced voltage in the line at the other towers is still very high. The increase in induced voltage in lines can cause flashover across insulators.

#### 3.4. Striking with the presence of TLA

It is obvious that substation arresters didn't reduce the back flashovers as shown in Fig. 21. In this case transmission line arresters TLA across insulators are used to eliminate the flashovers across insulators. Fig. 23 shows how the TLA eliminates the back flashover occurrences safely without exceeding voltage-time curves of flashover.

#### 4. Conclusion

In this paper, the effect of lightning current injected at the top of transmission tower as well as at maximum sag location of 500 kV transmission system is simulated with and without using surge arresters. The obtained results report that the sag of transmission line has an obvious effect on V-t characteristics

caused by lightning surges and consequently transient over-voltage protection.

Based on the obtained results, it was found that the surge arresters which connected to substations have only a considerable influence on reducing induced voltage of phase conductors under lightning conditions. Surge arresters failed to reduce all induced back flashovers especially across line insulators.

On the other hand, not only induced voltage is obviously reduced but also back flashover across insulators is affected by the presence of transmission line arresters, while, both transient overvoltages and back flashover across insulators are not affected by the connecting of substation surge arresters. Thus, installation of transmission line arresters across insulators are the proper solution in order to minimize back flashovers as revealed from the obtained results.

#### Acknowledgments

The authors would like to thank the Deanship of Scientific Research and Research Center at the College of Engineering,

King Saud University for the financial support to carry out the research work reported in this paper. Special gratitude is due to Prof. S. Alghuainam and Prof. N. Malik for their technical guidance and participation to accomplish this work.

## References

- Bollen, M.H.J., Styvaktakis, E., Gu, I.Y.H., 2005. Categorization and analysis of power system transients. *IEEE Trans. Power Delivery* 20 (3), 2298–2306.
- Chowdhuri, P., 2001. Parameters of lightning strokes and their effects on power system. In: *Transmission and Distribution Conference and Exposition, Atlanta, GA*.
- IEEE Guide for the Application of Metal-Oxide Surge Arresters for Alternating-Current Systems, 1992, IEEE Std C62.22-1991, p. 0\_1.
- IEEE Guide for the Application of Metal-Oxide Surge Arresters for Alternating-Current Systems – Redline, 2009, IEEE Std C62.22-2009 (Revision of IEEE Std C62.22-1997) – Redline, pp. 1–177.
- IEEE working groups, 1992. Modeling of metal oxide surge arresters. *IEEE Trans. Power Delivery* 7 (1), 8.
- Martinez-Velasco, J.A., Castro-Aranda, F., 2005. Modeling of overhead transmission lines for lightning studies. In: *International Conference on Power Systems, Montreal, Canada*.
- Mazur, V., Ruhnke, L.H., 2003. Determining the striking distance of lightning through its relationship to leader potential. *J. Geophys. Res. Atmos.* 108 (D14), 4409.
- Meister, A., Shayani, R.A., Oliveira, M.A.G.d., 2011. Comparison of metal oxide surge arrester models in overvoltage studies. *Int. J. Eng. Sci. Technol.* 3 (11), 11.
- Sun, S., Tremouille, G., 2012. Lightning Invasion Overvoltage Study for UHVAC Substation. *CIGRE*.
- Steinfeld, K., Gohler, R., Fredersdorff, A.L., 2002. Rating and design of metal-oxide surge arresters for high voltage AC systems. In: *Power System Technology, 2002. Proceedings. PowerCon 2002. International Conference on*.
- Talib, D.N.A., Bakar, A.H.A., Mokhlis, H., 2012. Parameters affecting lightning backflash over pattern at 132kV double circuit transmission lines. In: *Power and Energy (PECon), 2012 IEEE International Conference on*.
- Yadee, P., Prem, S., 2007. Analysis of tower footing resistance effected back flashover across insulator a transmission system. In: *International Conference on Power Systems Transients, Lyon, France*.
- Zakaria, Z. et al, 2002. Simulation of lightning surges on tower transmission using PSCAD/EMTDC, A comparative study. In: *Student Conference on Research and Development Proceedings, Shah Alam, Malaysia*.