

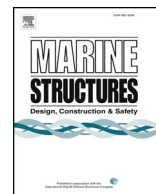

Contents lists available at ScienceDirect

Marine Structures

journal homepage: www.elsevier.com/locate/marstruc

Prototype testing for the partial removal and re-penetration of the mooring dolphin platform with multi-bucket foundations

Le Conghuan^{a,b,c,*}, Ding Hongyan^{a,b,d}, Zhang Puyang^{a,b}

^a State Key Laboratory of Hydraulic Engineering Simulation and Safety, Tianjin University, Tianjin 300072, China

^b School of Civil Engineering, Tianjin University, Tianjin 300072, China

^c State Key Laboratory of Coastal and Offshore Engineering, China

^d Key Laboratory of Coast Civil Structure Safety (Tianjin University), Ministry of Education, Tianjin 300072, China

ARTICLE INFO

Keywords:

Multi-bucket foundations
Shear strength factor
Mooring dolphin platform
Removal
Prototype testing

ABSTRACT

The partial removal, adjusting, and re-penetrating tests were carried out on a mooring dolphin platform with three-bucket foundations after a seven-year service. When the bucket foundations were penetrated by internal and external pressure differential, the soil shear strength around the bucket skirt was different from that of the intact soil after installation. The side shear strength along the skirt may be increased with time due to the set-up effect. The shear strength factor α is an important time-varying factor to determine the skin friction of the foundation during installation and removal operations. The shear strength factors obtained by prototype records and theoretical methods in cohesive soils are compared, from total stress to effective stress methods. In addition, the prototype tests show that the foundations will be able to resist removal forces that are significantly larger than penetration forces due to the set-up effect after a long working time. The results show an 85% increase in the soil resistance after seven years for the three-bucket foundations with diameters of 6 m and penetration depths of 8.5 m. Meanwhile, the construction procedure and operation of the three-bucket foundations and the analysis of the extraction forces are also given for the partial removal. The test results support the successful removal by a reasonable overpressure without soil plug failure inside the buckets by controlling the pump discharge inside the buckets and reutilizing the structure with multi-bucket foundations after an initial service period of seven years.

1. Introduction

Bucket foundations are a promising cost-effective type of foundation for ocean engineering [1–6]. Among the costs of geo-technical investigation, material, fabrication and installation, the most significant savings are from installation due to self-installed technology. No complex installation equipment and expensive large crane barges are required. The installation time, which is normally within 24 h, is greatly shortened compared with the several days required for a conventional platform foundation. First, the bucket foundation partially penetrates the soils under its dead weight. Then, the differential pressure across the top of the foundation, between the hydrostatic water pressure outside of the bucket and the reduced water pressure inside the bucket, created by pumping out the water trapped inside the bucket chamber from the top of the bucket, in addition to the weight, can trigger further penetration of the foundation to the desired depth. Bucket foundations also have significant bearing capacity, high positioning accuracy, and mobility, which have been successfully applied as effective solutions for anchoring in deep water and have also been applied as the

* Corresponding author. State Key Laboratory of Hydraulic Engineering Simulation and Safety, Tianjin University, Tianjin 300072, China.
E-mail addresses: leconghuan@163.com, lch@tju.edu.cn (C. Le).

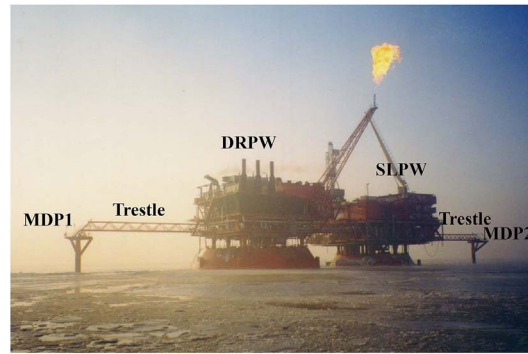

Fig. 1. MDP and other structures at Bohai Sea site.

foundations of jacket structures, jack-up rigs, mooring structure and offshore wind turbines [7–12]. Meanwhile, relocatable structures with bucket foundations can be reused at different sites, and the removal of the structure also provides a clean site after exploitation which accommodates environment-friendly concerns.

Two mooring dolphin platforms (MDP1 and MDP2) with multi-bucket foundations were installed in the JZ9-3 field of the Bohai Sea in 1999 [13,14]. They are located on two sides of the drilling & accommodation wellhead platform (DRPW) and storage loading platform (SLPW). As shown in Fig. 1, MDP1 and MDP2 are connected to the main platforms by the trestles. The mooring dolphin platforms have been in operation for many years, and the removal process of the three-bucket foundation platform had not undergone prototype testing until 2006. An illustration of the prototype test processing and the analysis of the removal forces observed in the test are provided in the paper. The results have certain implications on how to guide the construction procedure and further studies on removal forces. The prototype tests provide an enhancement of the bearing capacity due to an increase of side friction resistance on the bucket skirts during the seven years. In fact, self-weight penetration is similar to the installation of open-ended piles, with significant amounts of the soils replaced by the skirt wall moving outside the skirt wall. When underpressure is applied, the soils replaced by the skirts will mainly move into the skirt compartment. A thin zone of soils along the skirts will be remolded in both phase, and the shear strength along the skirts will be reduced to the remolded shear strength. There will be a set-up effect, with the shear strength increasing with time due to the dissipation of excess pore pressure after penetration, increased horizontal normal effective stress and thixotropy (gain in shear strength with time with no change in volume) [15].

The penetration resistance is made up of the side friction resistance along the skirt walls and the bearing resistance at the skirt tip. When the bucket foundations are penetrated by suction or underpressure, soil shear strength around the skirt is different from that of the intact soil after installation. The suction pressure inside the bucket foundations may induce seepage flows around and inside the buckets, which will result in a reduction of penetration resistance at the skirt tip and along the inner skirts. This characteristic in sandy soils with high permeability can more evidently promote the installation of bucket foundation than in clayey soils with low permeability. The lower permeability soils need more time and suction to set up seepage flows to lower the soil resistance during the penetration phase or larger water pressure inside the bucket foundations during the removal phase. The reduction in resistance by seepage should be considered in the calculation. As a contingency during installation or if the foundation will be removed after an operation, recovery can be achieved by pumping water into the confined compartment, thus creating an overpressure that will drive the foundation out of the ground [15–21]. The same equations used for the penetration analysis are employed for the removal analysis. The side shear along the skirt may be higher than during penetration due to “set-up” with time. The relative importance factor during the operation in clay is the shear strength factor α varying with time. Typical α values have been found to increase from installation to extraction after limited consolidation (a minimum of 10 days at prototype scale) [22,30]. This paper mainly concentrates on the shear strength factor α in penetration and removal analyses.

2. Site characteristics and testing procedures

The mooring dolphin platform consists of three-bucket foundations, a mooring dolphin, and a truss structure. As illustrated in Fig. 2, each bucket foundation is 6 m in outside diameter and 9 m in height. The distance between the center lines of the bucket foundations is 15 m. The diameter of the mooring dolphin is 1.5 m. The mooring dolphin platform is located at a mean water depth of 7.4 m in the Bohai Sea area of China. And the total weight of the platform structure is 2228 kN [13,14].

The seabed soils properties were determined by laboratory testing on undisturbed soil samples acquired from three geotechnical investigation drilling boreholes. The soil conditions at the sites were relatively uniform and composed of organic silt, silty clay and clay, which indicated a typical Bohai sea soil profile with a normal unit weight (the average of unit weight was 18.1 kN/m^3 for 0–5 m soil and 19.3 kN/m^3 for 5–15 m). The undrained shear strength profile increased nearly linearly in the depth (z) range of 0–10 m, which was expressed as $s_u = 7 + 1.49z$ (kPa). The liquid limit of the soils ranged from 22% to 47%, and the plasticity index was

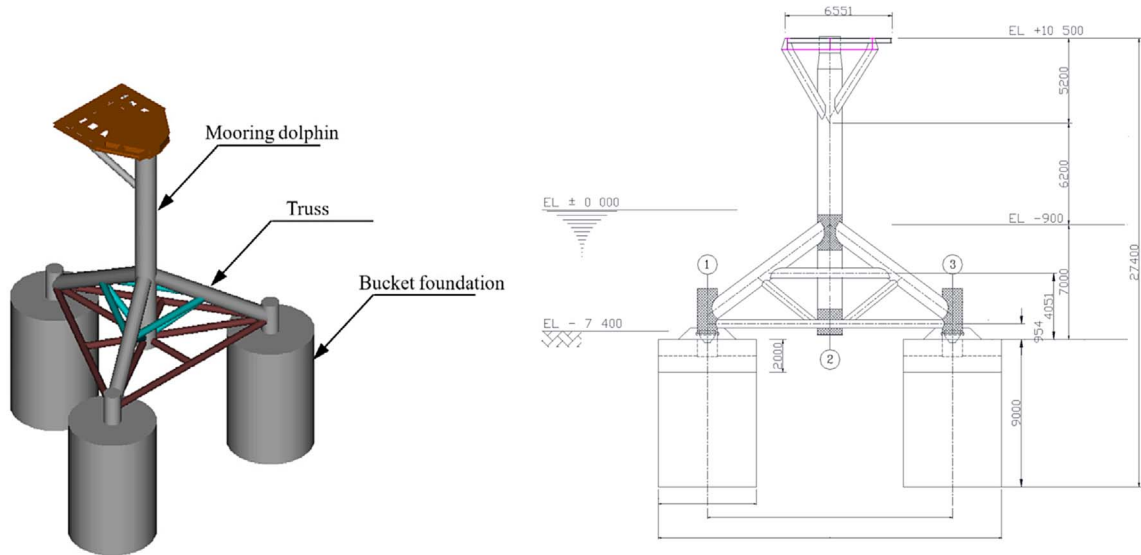

Fig. 2. Sketch of mooring dolphin platform (MDP2).

between 16% and 25%. Soil permeability k ranged from 8.5×10^{-7} m/s (0–3 m below the mudline), 3.9×10^{-8} m/s (3–5 m below the mudline), and 9.3×10^{-8} m/s (5–10 m below the mudline) to 1.2×10^{-9} m/s (10–15 m below the mudline). The over-consolidation ratio of soils were 2.45–1.0 from mudline down to approximately 3 m and 1–0.45 in the depth range of 3 m to approximately 15 m. More details of the soil properties of the sites are reported in the literature [13,14]. In a word, seabed soils within the depth of bucket foundations can be described as cohesive soils with low plasticity, low permeability, and low-to-medium sensitivity.

Prototype partial removal and re-penetration tests of the MDP2 platform were performed on site in 2006 to determine the real removal behavior of the platform after its seven-year service. Preparatory work for the prototype tests was conducted before testing, including measuring the initial inclination angle of the platform, connecting the circuits of monitoring equipment, among others. The mooring dolphin platform (MDP2) was removed and re-installed according to the following main procedures:

- (a) Cutting the welding connection between the platform and the trestle bridge to eliminate the internal stress caused by rigid constraints.
- (b) Removal process of the MDP2: water was pumped into the buckets until the platform was removed, i.e., simply reversing the installation procedure. During the processing, the platform with three buckets moved upward as a whole structure, and each bucket foundation moved with different displacements due to the different pumping values for the bucket foundations.
- (c) Re-installation and adjusting process of the MDP2: water was pumped out of the bucket foundations, which generated the suction (relative to the water pressure outside of the bucket foundations) within the buckets penetrated the foundations to the required depth.
- (d) The MDP2 and the trestle bridge were reconnected and the MDP2 was used for the moorings of oil tankers again.

The pressure difference across the lids generated by pumping water into the bucket foundations and the displacements of each bucket foundation were measured during the removal process of the MDP2. The relative positive pressure was provided by the pump systems. Each bucket foundation was equipped with one pump, whose water head of delivery is 30 m and whose flow rate is 40 m^3 per hour. The theoretical pumping water amount was 0.282 m^3 per 10 mm of upward displacement; it would take 30 s to remove 10 mm using the pump system. The extraction force produced by the pump system is far beyond the theoretical removal resistance, which provides a safety factor for the construction. During the construction process, the flow rate was controlled according to the monitoring data provided by the field measurement system which measured and displayed the real-time situation, such as the platform inclination and the differential water pressure between the hydrostatic water pressure outside the buckets and the induced water pressure inside the buckets.

After the removal test, the buckets were re-penetrated to the targeted depth by reversing the removal process—that is, by re-connecting the pump and pumping water out of the buckets. The three bucket foundations were pumped in sequence and the platform gradually reached its design depth. After the re-penetration process, the trestle was again welded onto the top of the platform, as it was cut from the platform before the removal test.

3. Test results

3.1. Calculation methods of skin friction

The concept of using differential water pressure as the driving force for penetration or removal is applied in platforms with bucket foundations. The structure will be penetrated into or removed from the soil as long as the driving force is larger than the soil resistance. The penetration force is calculated as the sum of the submerged weight of the structure and ballast, and suction created by an external pumping system. By comparison, the removal resistance consists of friction resistance between the skirt wall and the surrounding sediments and the submerged weight of the structure and the ballast. The retrieval force is a positive pressure created by an external pumping system. Generally, skin friction is the most important factor for the feasibility of penetration and removal.

In cohesive soils, the shaft friction f at any point along the bucket foundation may be calculated by the following equation:

$$f = \alpha s_u \tag{1}$$

where α is a dimensionless factor and s_u is the undrained shear strength of the soil at the point in question, $s_u = 7 + 1.49z$ (kPa).

The factor α can be computed by the equations from various methods:

(1) Method I (API, 1984) [23]:

API (1984) suggests values for α as a function of s_u as follows:

$$\begin{cases} s_u \leq 24 \text{ kPa} & \alpha = 1.0 \\ s_u \leq 72 \text{ kPa} & \alpha = 0.5 \\ 24 < s_u < 72 \text{ kPa}, & \alpha \text{ is taken as the linear interpolation method} \end{cases} \tag{2}$$

Similarly, when $12 < s_u < 24$ kPa, $\alpha = 1.00-0.96$ for timber and concrete piles and $1.00-0.92$ for steel piles in Ref. [24].

(2) Method IIa (API, 2000; DNV-RP-E303-2005) [25,26]:

The equation by API (2000) and DNV (2005) suggests values for α as follows:

$$\alpha = \begin{cases} 0.5\psi^{-0.5}, & \psi \leq 1.0 \\ 0.5\psi^{-0.25}, & \psi > 1.0 \end{cases} \tag{3}$$

with the constraint that $\alpha \leq 1.0$, where $\psi = s_u/p'_0$ for the point in question and p'_0 is the effective overburden pressure at the point in question (kPa). Simple rules to obtain coefficient α based on $\psi = s_u/\sigma'_v$ are proposed in standard DNV-OS-J101-2007 [27].

(3) Method IIb (Kolk and Van der Velde method [28]):

Coefficient α value in the Kolk and Van der Velde method is based on the ratio of undrained shear strength and effective stress, as shown in Table 1.

(4) Method IIc (Norwegian Geotechnical Institute, NGI-99) [29]:

Karlsrud et al. [29] proposed the modification of the NGI method by introducing the correlation of s_{ud}/σ'_{v0} and I_p with α coefficient presented by the trend lines indicated in Fig. 3, known as NGI-99. Studies have shown that the plasticity index I_p has a large impact on the mobilized ultimate shaft friction and corresponding α value.

(5) Method IIIa (Andersen and Jostad 2002, 2004) [22,30]:

$$\alpha = 1/S_t \tag{4}$$

where S_t is sensitivity without lateral restraint (see Table 2).

(6) Method IIIb (DNV-RP-E303-2005; Andersen and Jostad, 2004) [26,30]:

Table 1
 α values dependent on s_u/σ'_v (Kolk and Van der Velde method).

s_u/σ'_v	0.2	0.3	0.4	0.5	0.6	0.7	0.8	0.9	1	1.1	1.2	1.3	1.4
α	0.95	0.77	0.7	0.65	0.62	0.6	0.56	0.55	0.53	0.52	0.5	0.49	0.48
s_u/σ'_v	1.5	1.6	1.7	1.8	1.9	2	2.1	2.2	2.3	2.4	2.5	3.0	4.0
α	0.47	0.42	0.41	0.41	0.42	0.41	0.41	0.4	0.4	0.4	0.4	0.39	0.39

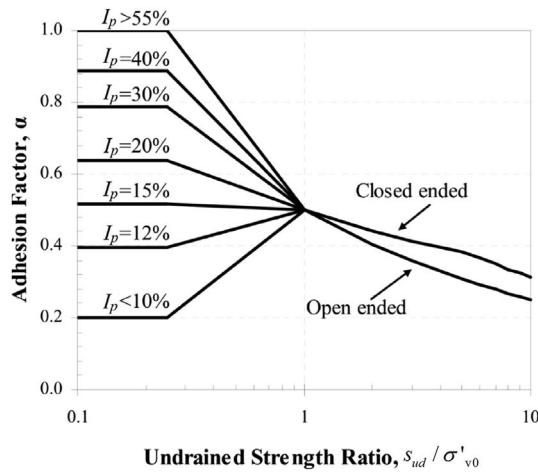

Fig. 3. Measured values of α in relation to normalized strength, for all piles (Karlsruud et al. [29]).

Table 2
St for method III.

Soil Depth (m)	St	1/St (Method IIIa)	1.4/St (Method IIIb)
1	2.95	0.34	0.48
2	2.95	0.34	0.48
3	2.95	0.34	0.48
4	2.95	0.34	0.48
5	2.84	0.35	0.49
6	2.56	0.39	0.55
7	1.83	0.55	0.77
8	1.48	0.68	0.95
9	1.85	0.54	0.76

The set-up factor α after 3 months along the skirt inside an anchor with no inside stiffeners can be estimated as $1.4/S_t$ ($I_p < 30$) (see Table 2).

In addition, Houslyby and Byrne (2005) proposed the design procedures for the installation of suction caissons in clay and other materials [31]. The shear strength factors α_o and α_i on the outside and inside of the caisson, respectively, are used in undrained pile design. The shear strength factor α of 0.6 for the outside of the bucket and 0.5 for inside and for the stiffeners are proposed.

3.2. Analysis of skin friction

There were some records about two other cases of penetration and removal tests at test Site A, 32 m away from the installation Site B, in 1999, and penetration installation at Site B in 1999. The details of the measurement and the results were reported in the literature [13,14]. Fig. 4(a) illustrates the unit skin frictions with the skirt depth of bucket foundation during the installation phases in 1999 and retrieval phases in 1999 and 2006 at Sites A and B. The measured values are the unit skin friction for every meter in depth, and the average values are evaluated as the total skin friction divided by the surface area of the outside skin at the corresponding penetration or removal depth. The two penetration processes showed the same trend for the unit skin friction and the averages. With the increase in depth, the skin friction clearly decreased due to seepage after the self-weight penetration. In addition, the different change at 5 m depth at Site B implied a tilt-adjusting operation. The unit skin friction increased from 13.4 kPa at a 4 m depth to 15.5 kPa at a 5 m depth, then decreased to 10.8 kPa at a 6 m depth after the tilting processing. The lower effective stress state along the outside skirt could not recover even after the dissipation of excess pore water pressures which has been confirmed by Andersen and Jostad (2002) [22]. The skin friction during the removal processing, which occurred 12 h after installation, verified this conclusion, except that the skin friction at the beginning of the removal, which was mainly due to a rapid setup effect in silty clay. Another reason was that the occurrence of tilting caused by different uplift forces obtained by pumping water into the bucket foundations. However, in regard to the partial removal tests in 2006, the average of unit skin friction was 22 kPa (see Fig. 4(a)), which was 2.45 times the 9.0 kPa of the retrieval testing in 1999 at Site A and 1.85 times the 11.9 kPa of penetration installation in 1999 at Site B.

Fig. 4(b) illustrates the factor α for every meter in depth as determined by Methods I, IIa-c, and IIIa, b, and the measured values of the unit skin friction in all prototype tests. The results show that all the calculation methods underestimate the friction resistance at the upper penetration depth until a certain penetration depth. With the increase of penetration depth, the friction resistances are overestimated by the three methods. The main reasons are stated as follow:

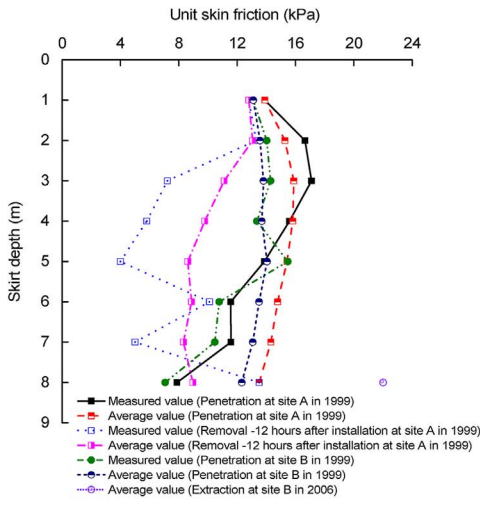

(a) The measured unit skin friction in prototype tests

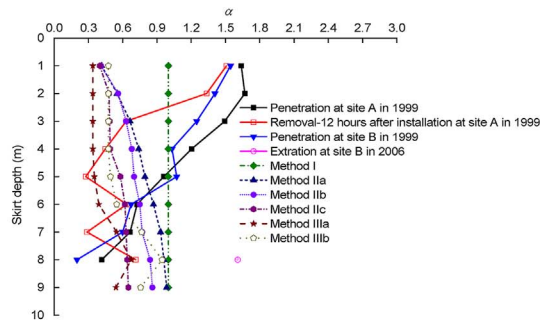

(b) Adhesion factor α obtained by testing data and theoretical methods

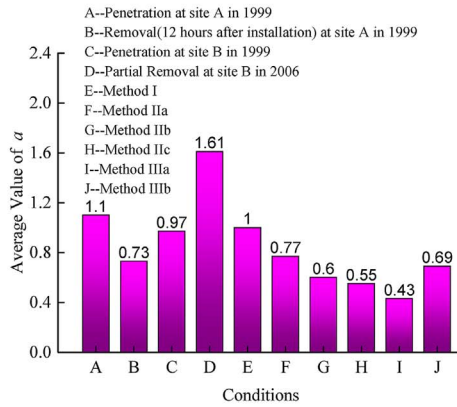

(c) Average of α values from theoretical methods and prototype tests

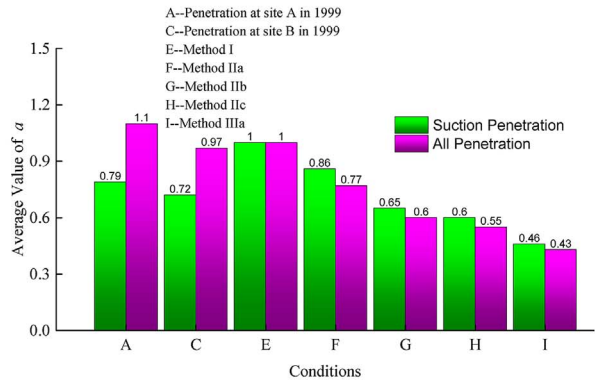

(d) Average of α values for penetration process

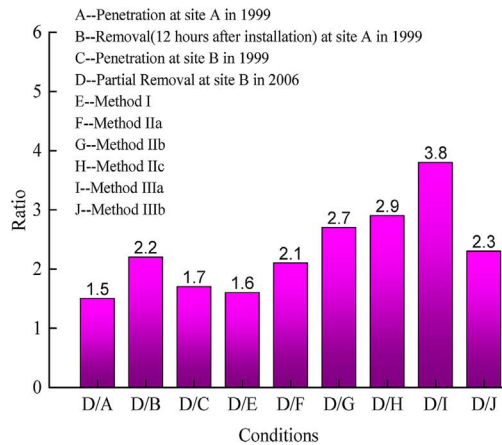

(e) Ratio for α average values between that of partial removal and other values

Fig. 4. Skin friction.

- 1) To consider the uncertainty in the friction near the surface of the soil with high ψ ($\psi = s_u/p'_0$), the factor α is artificially lower in the effective stress method with some engineering judgment due to the lack of pile load tests in soils having $\psi = s_u/p'_0$ ratios greater than three. In other words, the contribution of deeper soil is considered, but the surface layer soil is underestimated with Method II. As a result, the computed shaft frictions are probably lower than the real values.
- 2) During the installation process, the clay surrounding the bucket foundation is remolded. As the excess pore pressures rapidly

decrease with radial distance from the bucket foundation, water begins to flow laterally out of the disturbed zone, and the clay consolidates as time goes on. The bearing capacity of the bucket foundation increases as pore pressures dissipate. This phenomenon is called set-up. Method II is for determining the pile bearing capacity in working situations by considering the set-up effect, which is not directly suitable for the evaluation of the installation of bucket foundations by suction, as the soil consolidation around the skirt wall will not happen in the short processing.

- 3) Method III, in which factor α is calculated by the soil sensitivity S_t without lateral restraint, is worth discussing further. The shear strength of the clay along the cylinder buckets would be reduced to the remolded shear strength during underpressure penetration. Therefore, the shear strength is the original strength divided by the sensitivity. After penetration, there will be a set-up effect, the shear strength of the clay along the skirt wall increasing with time due to the dissipation of excess pore pressure, an increase in horizontal effective stresses, and an increase in the shear strength of the soil by the thixotropy effect (Andersen and Jostad 2002, 2004) [22,30].

Furthermore, the recorded skin friction of the removal test in 1999 coincides relatively well with that determined by Methods IIc and IIIa, b below the 4 m depth. The removal friction was small because the experimental removal work was quickly performed, 12 h after the penetration work at test Site A. The soil around the bucket foundation did not recover from the disturbance of the penetrating work. By contrast, the factor α was more than 1.6 for the partial removal in 2006, which was much larger than values obtained by the theoretical method. Fig. 4(c) and (d) illustrate the average of factor α , in which the value obtained by Method I was in good agreement with that obtained by the two penetration tests in 1999, and the values obtained by Methods IIa and IIIb were in good agreement with that obtained by the removal tests in 1999. Meanwhile, the average of factor α for the partial removal after a seven-year service was over 3 times the minimum obtain by Methods IIIa, which was 1.5 times and 1.7 times the values for the two penetration tests, respectively (see Fig. 4(e)). In regards to suction penetration (see Fig. 4(d)), the average of factor α obtained by Method IIa was larger than that obtained by the installations at sites. The average values from Methods II and III for suction penetration were larger than that for all installations, while the opposite phenomenon appeared in installations at sites due to the reduced resistance caused by the seepage.

The shear strength factor ($\alpha = s_{uRR}/s_{u0}^{DSS}$, where s_{uRR} is the shear strength of reconsolidated remolded clay, and s_{u0}^{DSS} is the original shear strength determined in direct simple shear tests) proposed for normally consolidated clays in capacity analyses was 0.58 for Norway silty clays ($I_p < 20\%$, $S_t < 3$) by Andersen and Jostad (2002) [22]. However, the soil in the prototype tests was mainly low-to-medium sensitivity silty clay. For the soil, the s_{u0}^{DSS} was only approximately 2 kPa with 25°–30° friction angle. The shear strength factor would be much larger than 0.58 if using the DSS value instead of the UU value for the silty clay.

Meanwhile, the shear strength factor α based on thixotropy effect, immediately after installation and before any pore pressure dissipation, can be calculated as $\alpha = C_t(1/S_t)$ [26]. And the calculated value should not exceed the values from API (2000) [25]. The thixotropy factor C_t , the ratio between the shear strength after a certain time with thixotropic strength gain and the shear strength just after remolding, was calculated by the measured values in prototype tests as shown in Fig. 5. In practice, the thixotropy effect means that it is possible to rely on shear strength along the skirt walls of bucket foundations soon after installation, which is higher than the remolded shear strength, even before pore pressure dissipation occurs (Andersen and Jostad, 2002) [22]. In addition, Andersen and Jostad (2004) [30] also recommended a set-up factor. The set-up factor after 10 days was $1.15/S_t$, and it was $1.4/S_t$ for 3 months when $I_p < 30\%$. The set-up factor would be 0.4 for 10 days and 0.5 for 3 months from the 0–6 m depth, as well as 0.6 for 10 days and 0.8 for 3 months below a 7 m depth. By comparison, Fig. 4(e) presents a ratio between the α value for the removal after a seven-year

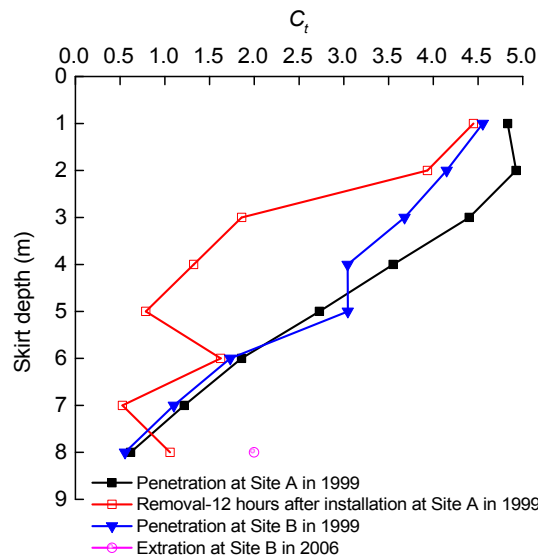

Fig. 5. The thixotropy factor C_t due to Set-up.

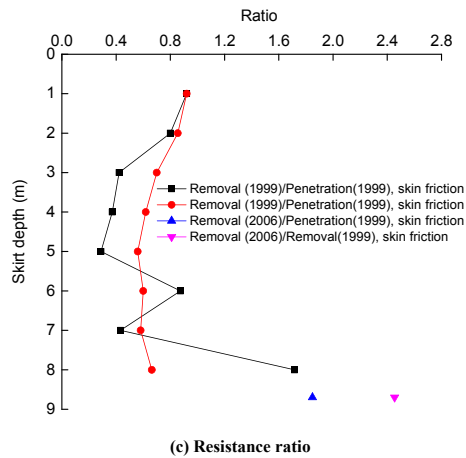
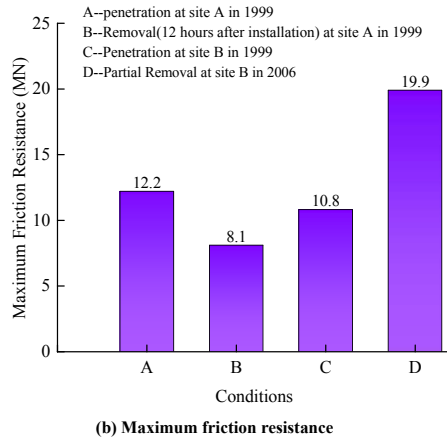
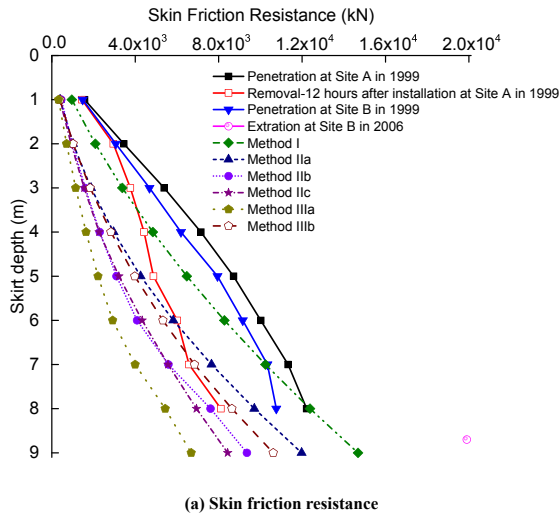

Fig. 6. Comparison of skin friction resistance for all tests.

service and the average α value for other situations. The ratios were 1.47–2.20 for measured values and 1.61–3.75 for theoretical calculation of Bohai silty clay ($I_p < 25\%$, $S_t < 3$). There may therefore be potential for higher set-up factors by performing tests on site specific clays.

Fig. 6 shows the comparison of skin friction resistances from tests and calculated by the three methods. As shown in Fig. 6(a), the recorded skin friction of the three test cases coincides relatively well with that determined by Method I, and the results calculated by

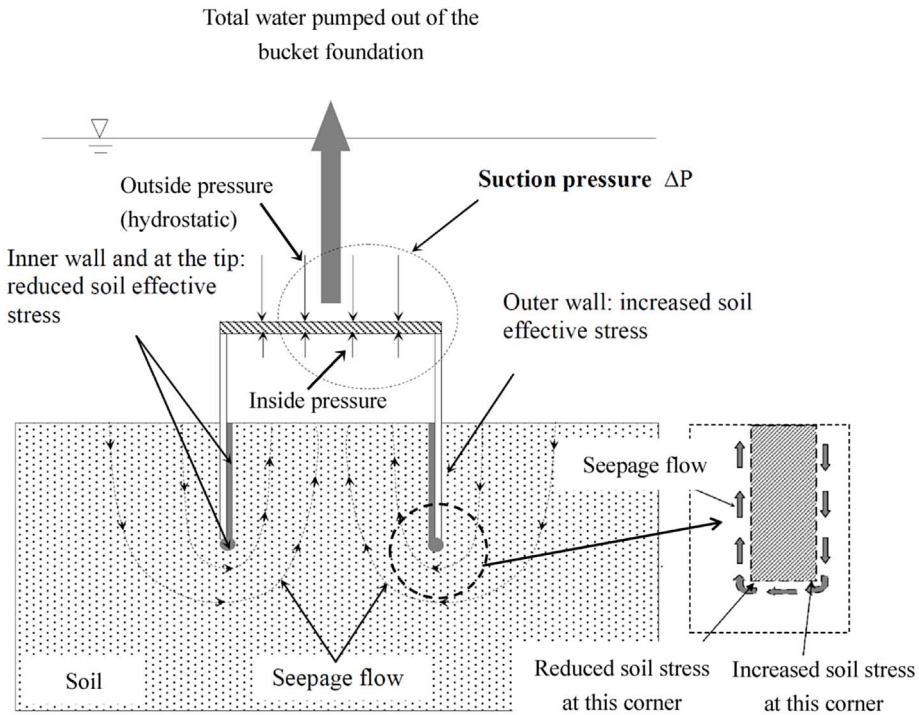
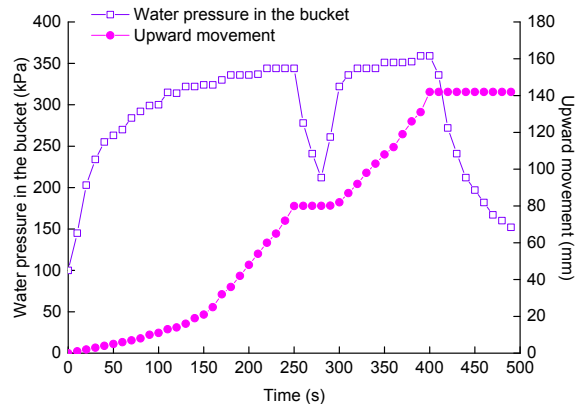

Fig. 7. Seepage flow condition around the bucket skirt tip during suction installation (Tran 2005 [34]).

Methods II and III were relatively smaller (Method IIa > IIIb > IIB, c > IIIa). The removal data from 12 h after installation was in good agreement with skin friction resistances by Methods IIB, c and IIIb when the penetration depth was greater than 5 m. In addition, Fig. 6(a) illustrates another phenomenon, in which the increasing slope of resistance becomes smaller after the penetration exceeds 5 m for two penetration tests, which was mainly caused by the seepage effect. After the self-weight penetration of 4.5 m, the suction pressure inside the buckets could induce seepage flow through the soil, which will result in a reduction in the effective stress at the bucket tip and along the inner wall, and thus reduce the resistance to a certain extent. This characteristic can evidently promote the installation of bucket foundations in sandy seabed (Tran and Randolph 2008) [32]. However, suction installation in clay usually does not induce significant seepage due to the lower permeability. Therefore, in the clayey or silty soil on site, mentioned above with lower permeability of the soil (from 8.5×10^{-7} m/s to 9.3×10^{-8} m/s), required more time and suction to set up seepage flows in order to lower tip resistance.

The maximums of friction resistance in all prototype tests are summarized in Fig. 6(b) by assuming internal unit skin friction is equal to external unit skin friction, which may lead to a slight overestimation for the external friction is higher than the internal value proposed by Jeanjean (2006) [33]. Fig. 6(c) illustrates that the maximum removal friction force in 2006 was 2.45 times the maximum removal friction force at site B in 1999, 1.62 times the maximum penetration friction force at site A in 1999, and 1.84 times the maximum penetration friction force at site B in 1999. By comparison, Colliat and Colliard (2010) [21] suggested that the ratio was 1.36–2.03. The prominent increase of skin resistance in the removal force implied the friction factor between the soil and bucket skirt became larger, especially for the underconsolidated silty clay. And the thixotropy also results in the increase of resistance for further penetration or retrieval once the penetration process is temporarily stopped. If the stop is longer than a few hours, then strength increase due to pore pressure dissipation and increased effective stresses should also be considered (Andersen and Jostad, 2002) [22].

As shown in Fig. 7 (Tran 2005) [33], in suction installation, the suction pressure, which helps install the bucket foundation by means of the differential pressure Δp , also induces seepage flow through the exterior soil around the skirt tip into the bucket. Depending on the flow direction, the seepage can have different impacts on the soil. Regarding the external bucket skirt, the downward seepage gradient resulting from the suction application leads to an increase in effective stress of the soil. On the other hand, the upward flow gradient inside the bucket reduces the soil effective stress at the skirt tip and along the inner skirt, thus reducing the tip resistance and internal skin friction. However, regarding the outer corner of the skirt tip, the seepage flows around the skirt in the downward direction, thus increasing the local soil stress. Therefore, although the upward seepage and part of the horizontal flow may reduce the tip resistance significantly, a small proportion of tip resistance is likely to be present at the outer corner of the bucket skirt during penetration. In general, this reduction, especially of the tip resistance, results in a significant reduction in total driving force (the penetration force degradation effect), which assists the installation.



(a) Bucket A

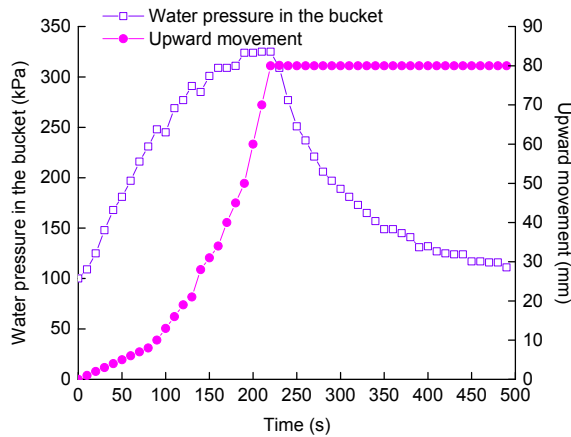

(b) Bucket B

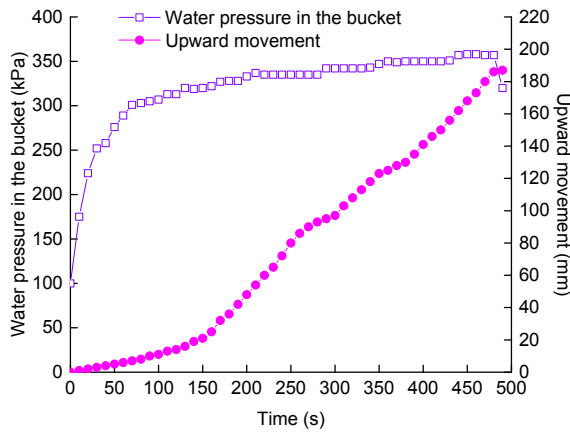

(c) Bucket C

Fig. 8. Water pressure in bucket foundations during removal processing.

Some similar installation tests in soft kaolin clay (El-Sherbiny 2005) [35] also illustrate that the interface friction acting on the bucket skirt during self-weight penetration is larger than that during suction penetration, mainly due to the lower inside skin friction during suction penetration, while the outside skin friction was practically unaffected by the suction. The reduction of resistance due to seepage should be considered in the calculations.

Table 3
Water pressure/removal force with time inside buckets during partial removal phase.

Time (s)	Bucket A		Bucket B		Bucket C		Total Removal force (kN)	Operation
	Water pressure (kPa)	Removal force (kN)	Water pressure (kPa)	Removal force (kN)	Water pressure (kPa)	Removal force (kN)		
0	100	0	100	0	100	0	0	Start Removal
10	145	1271.7	109	254.3	175	2119.5	3645.5	
20	203	2910.8	125	706.5	224	3504.2	7121.5	
30	234	3786.8	148	1356.5	252	4295.5	9438.8	
40	255	4380.3	168	1921.7	258	4465.1	10767.1	
50	263	4606.4	181	2289.1	276	4973.8	11869.2	
60	270	4804.2	197	2741.2	289	5341.1	12886.6	
70	284	5199.8	216	3278.2	301	5680.3	14158.3	
80	292	5425.9	231	3702.1	303	5736.8	14864.8	
90	299	5623.7	248	4182.5	305	5793.3	15599.5	
100	300	5652	245	4097.7	307	5849.8	15599.5	
110	315	6075.9	269	4775.9	313	6019.4	16871.2	
120	314	6047.6	277	5002.	313	6019.4	17069	
130	322	6273.7	291	5397.7	320	6217.2	17888.6	
140	322	6273.7	285	5228.1	319	6188.9	17690.8	
150	324	6330.2	301	5680.3	320	6217.2	18227.7	
160	324	6330.2	309	5906.3	322	6273.7	18510.3	
170	330	6499.8	309	5906.3	327	6415	18821.2	
180	336	6669.4	311	5962.9	328	6443.3	19075.5	
190	336	6669.4	324	6330.2	328	6443.3	19442.9	
200	336	6669.4	324	6330.2	333	6584.6	19584.2	
210	337	6697.6	325	6358.5	337	6697.6	19753.7	
220	344	6895.4	325	6358.5	335	6641.1	19895	Stop Pumping B
230	344	6895.4	309	5906.3	335	6641.1	19442.9	
240	344	6895.4	277	5002.	335	6641.1	18538.6	
250	344	6895.4	251	4267.3	335	6641.1	17803.8	Stop Pumping A
260	278	5030.3	237	3871.6	335	6641.1	15543	
270	241	3984.7	221	3419.5	335	6641.1	14045.2	
280	212	3165.1	206	2995.6	335	6641.1	12801.8	Open Pumping A
290	261	4549.9	197	2741.2	342	6838.9	14130	
300	322	6273.7	189	2515.1	342	6838.9	15627.8	
310	336	6669.4	181	2289.1	342	6838.9	15797.3	
320	344	6895.4	173	2063	342	6838.9	15797.3	
330	344	6895.4	165	1836.9	342	6838.9	15571.3	
340	344	6895.4	157	1610.8	343	6867.2	15373.4	
350	351	7093.3	149	1384.7	347	6980.2	15458.2	
360	351	7093.3	149	1384.7	350	7065	15543	
370	351	7093.3	145	1271.7	349	7036.7	15401.7	
380	352	7121.5	141	1158.7	350	7065	15345.2	
390	359	7319.3	131	876.1	350	7065	15260.4	
400	359	7319.3	0.132	904.3	350	7065	15288.7	Stop Pumping A
410	336	6669.4	0.127	763	350	7065	14497.4	
420	272	4860.7	0.125	706.5	350	7065	12632.2	
430	241	3984.7	0.124	678.2	351	7093.3	11756.2	
440	212	3165.1	0.124	678.2	357	7262.8	11106.2	
450	197	2741.2	0.117	480.4	358	7291.1	10512.7	
460	182	2317.3	0.117	480.4	358	7291.1	10088.8	
470	167	1893.4	0.116	452.2	357	7262.8	9608.4	
480	160	1695.6	0.116	452.2	357	7262.8	9410.6	Stop Pumping C
490	152	1469.5	0.111	310.9	320	6217.2	7997.6	

The significance of bold is the maximum removal force.

3.3. Removal processing

Fig. 8 and Table 3 show the time histories of measured water pressure, the upward movement, and the removal force for each bucket. The entire removal process lasted 480 s, with the same beginning time and different ending time for the three buckets. The initial water pressure was measured as 100 kPa inside the buckets. The pump for bucket A worked for 360 s while pumping 4 m³ water, the pump for bucket B worked 210 s while pumping 2.3 m³ water, and the pump for bucket C worked 480 s while pumping 5.3 m³ water. In addition, the pump for bucket A closed at 255 s, restarted at 285 s and closed at 405 s with a maximum water pressure of 359 kPa; the pump for bucket B closed at 225 s with a maximum water pressure of 325 kPa; and the pump for bucket C continued working throughout the whole process with a maximum water pressure of 358 kPa. As a result, bucket A was uplifted

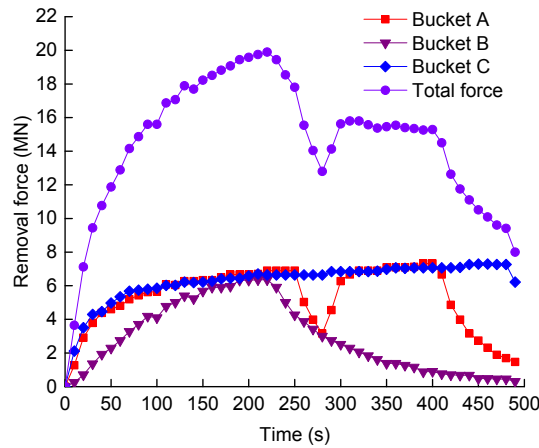

Fig. 9. Removal force during removal processing.

142 mm, bucket B was lifted 80 mm and bucket C was lifted 187 mm. It could be observed that, in general, the water pressure in bucket B showed an increasing trend until 235 s, after which the pump for bucket B was closed. Then, the water pressure in bucket B decreased slowly after the pump stopped.

Fig. 9 illustrates the time history curves of the total removal forces of MDP2. The measured peak removal forces for the bucket foundations were 7319 kN, 6356 kN and 7291 kN respectively. These values were much greater than the average 2702 kN recorded in 1999. Meanwhile, the total removal force for MDP2 was maximized at 19 895 kN, which was much greater than that recorded in 1999, the maximum skin friction during the penetration of the platform in 1999 and the theoretical results (see Fig. 6(a)). The ratio of the removal resistance to penetration resistance was obtained as 1.85, which was 1.36–2.03 in the study by Colliat and Colliard (2010) [21]. The increases of friction resistance were tested in-situ by the extraction of six suction piles at various set-up times, ranging from 1 day to 3.5 years, which were installed at three different sites with water depths ranging from 700 m to 1300 m (Colliat and Colliard, 2010) [21]. In addition, in 1999, the real penetration depth was 8.5 m, which means that 0.5 m of the bucket foundation was above the seabed. The drifting soils caused by the scouring of the SLPW platform due to tidewaters made the soil stack around the bucket foundations. Therefore, the external bucket foundations of MDP2 above the seabed were totally covered by soils. This special phenomenon was also beneficial to the increase of removal force.

As shown in Fig. 10 (Huang 2003) [36], the suggested method for bucket foundation retrieval is to overpressure (Δu) the inside of the bucket by pumping water into the bucket. However, too high overpressure may result in the removal failure. This is mainly because that the set-up effect occurs in the soil both inside and outside the bucket after installation, and the soil outside the bucket could regain its strength faster than the soil inside the bucket due to differences in drainage paths. Once a continuous seepage field appears along the inner skirt, the removal resistance (or the water pressure inside the bucket) would suddenly decrease with the soil structure failure. However, the phenomenon did not be observed in the prototype testing and the failure of soil structure did not occur. The most probable explanation for this is that the formation of a continuous seepage field requires more time and upward displacement in the cohesive soil.

The shear strength of the clayey soil along the skirt was reduced to the remolded shear strength during the skirt penetration processing [22,30]. After penetration, the shear strength of the clayed soil along the skirt wall will increase with time due to the dissipation of excess pore pressure, increase of horizontal normal effective stress, and the thixotropy effect. As a result, in the clayey or silty soil on site, the recovered shear strength at the interface between the skirt wall and the soils will influence the anti-removal

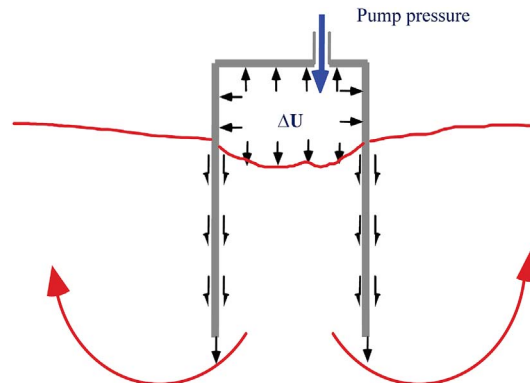

Fig. 10. Bucket foundation removal mode (Huang 2003 [36]).

capacity of bucket foundations. The lower permeability of the soil (from 8.5×10^{-7} m/s to 9.3×10^{-8} m/s) on site required more time and suction to set up seepage flow paths. The differential pressure between the inside and outside of the bucket foundations, generated by pumping water into the bucket foundations, would be suddenly lowered once the overflow line connected to the outside of the buckets. In the extraction testing in 1999, there was a significant drop in water pressure when the upward displacement of the bucket was around only 100 mm. After 7 years, the dramatic decrease of the removal resistance (or the water pressure inside the bucket foundations) did not appear in the extraction testing of 2006, though the upwards displacement was up to approximately 200 mm with approximately 0.4 MPa water pressure inside the bucket foundations, comparing with approximately 100 mm with approximately 0.2 MPa in the extraction testing 12 h after the penetration test of 1999. The set-up effect significantly increases the skin friction around the skirt wall.

3.4. Re-installation and readjusting processing

During the removal process of MDP2, the platform inclination appeared due to the displacement difference among the three buckets under the different soil conditions and internal water pressure. The real-time data shows that the maximum difference in height was 107 mm, while bucket B was 62 mm lower than bucket A and 107 mm lower than bucket C. In contrast, in 1999, the maximum height difference between the buckets was up to 600 mm during the self-weight penetration process and 240 mm during the penetration process. The final leveling after the 1999 installation was as follows: bucket A was 80 mm lower than bucket B and 110 mm lower than bucket C at a water depth of 10.96 m, while the top of bucket A was 160 mm above the seafloor. However, according to the measurements made by underwater divers, the bucket foundations were totally covered by muddy sea clay in 2006. It is worth mentioning that the whole settlement of the platform was less than 30 mm after the 1999 installation, as measured by a long-term monitoring device.

In 2006, according to the pre-designed program, the order of re-penetration was bucket C, bucket A, and bucket B, when the water depth was 11.56 m at what was considered a high water level. During the re-penetration, the maximum differential pressure (suction pressure) was -100 kPa. Compared with the maximum value of -144 kPa for the initial penetration in 1999, this value was lower for the destruction of soil around the bucket during the removal process.

At the beginning of the re-penetration and readjusting process in 2006, the pump for bucket B was closed until the difference among the three buckets nearly disappeared. Then, the simultaneous control and adjustment of the pump water discharge was performed by directly opening/closing the pumps for the three buckets instead of controlling the water flow into/out of pipes because the prior method was found to be quicker and more efficient in guaranteeing the correct execution of the penetration procedures.

Before the partial removal test, the trestle end connected to MDP2 was 58 mm lower than the trestle end connected to the SLPW platform. After partial removal and re-penetration tests, the average elevation of the buckets was raised by 50 mm. Ultimately, the trestle end connected to the MDP2 was 8 mm lower than the trestle end connected to the SLPW platform with the trestle bridge inclined by 0.012° . The inclination angles of MDP2 were 0.224° in the X-direction and 0.401° in the Y-direction.

4. Conclusions

Prototype testing of a mooring dolphin platform with three-bucket foundations for partial removal and re-penetration is described. Removal, adjustment and penetration were achieved by controlling the pump discharge into/out of the bucket foundations. The test demonstrates the removability of MDP2 with bucket foundations after seven service years from 1999 to 2006 and contributes to the development of design procedures for offshore structures supported by bucket foundations. In addition, it is of vital importance that the shear strengths for reconsolidated remolded soil should be considered in the practical calculation with the set-up time. Consequently, the foundations would be able to resist removal forces significantly larger than the penetration forces. The results in this paper show an increase of 85% in resistance after seven years for the three-bucket foundations, with a bucket diameter 6 m and penetration depth of 8.5 m. Therefore, the theoretical calculation of skin friction for bucket foundations is a difficult task, involving a series of variable parameters such as soil characteristics (especially plasticity), set-up effects, and penetration means (by under-pressure or by self-weight), etc. Recommendations for the determination of extraction resistance in practical designs would be worked out via further studies on the shear strength of reconsolidated remolded clay around bucket skirts, and the inner and outer interface friction factor increasing with time due to the dissipation of excess pore pressure, increase of horizontal effective stresses and the thixotropy effect.

Acknowledgements

The authors would like to acknowledge the support from the Innovation Method Fund of China (Grant No. 2016IM030100), the National Natural Science Foundation of China (Grant Nos. 51679163 and 51779171), the Tianjin Municipal Natural Science Foundation (Grant No. 17JCYBJC22000), and State Key Laboratory of Coastal and Offshore Engineering (Grant No. LP1709).

References

- [1] Monajemi H, Razak Abdul H. Finite element modeling of suction anchors under combined loading. *Mar Struct* 2009;22(4):660–9.
- [2] Le Conghuan, Ding Hongyan, Zhang Puyang. Air-floating towing behaviors of multi-bucket foundation platform. *China Ocean Eng* 2013;27(5):645–58.
- [3] Conghuan Le, Jiayi Yang, Hongyan Ding, Puyang Zhang. Test research on influence of draft on towing behaviors of 3-bucket foundation platform. *Trans Tianjin*

- Univ 2016;22:419–25.
- [4] Ding HY, Liu YG, Zhang PY, Xiong KP. Influential factors of bucket foundation for offshore wind turbine. *Trans Tianjin Univ* 2015;21(3):264–8.
- [5] Zhu B, Byrne B, Houlsby G. Long-term lateral cyclic response of bucket foundation foundations in sand. *J Geotech Geoenviron Eng* 2013;139(1):73–83.
- [6] Guo Z, Wang L, Yuan F, Li L. Model tests on installation techniques of bucket foundations in a soft clay seabed. *Appl Ocean Res* 2012;34:116–25.
- [7] Ding HY, Liu YG, Zhang PY, Le CY. Model tests on the bearing capacity of wide-shallow composite bucket foundations for offshore wind turbines in clay. *Ocean Eng* 2015;103:114–22.
- [8] Li D, Zhang Y, Feng L, Gao Y. Capacity of modified suction caissons in marine sand under static horizontal loading. *Ocean Eng* 2015;102:1–16.
- [9] Liu R, Chen GS, Lian JJ, Ding HY. Vertical bearing behaviour of the composite bucket shallow foundation of offshore wind turbines. *J Renew Sustain Energy* 2014;7:013123.
- [10] Ding HY, Lian JJ, Li AD, Zhang PY. One-step-installation of offshore wind turbine on large-scale bucket-top-bearing bucket foundation. *Trans Tianjin Univ* 2013;19(3):188–94.
- [11] Luke Adam M, Rauch Alan F, Olson Roy E, Mechem Elliott C. Components of bucket foundation capacity measured in axial pullout tests. *Ocean Eng* 2005;32(7):878–91.
- [12] Zhang JF, Zhang XN, Yu C. Wave-induced seabed liquefaction around composite bucket foundations of offshore wind turbines during the sinking process. *J Renew Sustain Energy* 2016;8(2):023307.
- [13] Zhang PY, Ding HY, Le CH. Installation and removal records of field trials for two mooring dolphin platforms with three bucket foundations. *J Waterw Port Coast Ocean Eng* 2013;139(6):502–17.
- [14] Zhang PY, Ding HY, Le CH. Penetration and removal of the mooring dolphin platform with three caisson foundations. *J Offshore Mech Arctic Eng Trans ASME* 2013;135(4):041302.
- [15] Knut Andersen. Foundation Design of Skirted Foundations and Anchors in Clay, *Proceedings of Offshore Technology Conference OTC*, 05/1999.
- [16] Bang S, Preber T, Cho Y, Thomason J, Karnoski SR, Taylor RJ. Suction piles for mooring of mobile offshore bases. *Mar Struct* 2000;13(4–5):367–82.
- [17] Andersen KH, Jostad HP, Dyvik R. Penetration resistance of offshore skirted foundations and anchors in dense sand. *J Geotech Geoenviron Eng* 2008;134(1):106–16.
- [18] Cao J, Phillips R, Popescu R, Al-Khafaji Z, and Audibert J. M. E. Penetration resistance of bucket foundations in clay. *Proc., 12th Int. Offshore and Polar Engineering Conf. 2002, ISOPE, San Francisco*, 800–806.
- [19] Aubeny C, Murff JD. Simplified limit solutions for the capacity of suction anchors under undrained conditions. *Ocean Eng* 2005;32(7):864–77.
- [20] Chen W, Zhou H, Randolph MF. Effect of installation method on external shaft friction of caissons in soft clay. *J Geotech Geoenviron Eng* 2009;135(5):605–15.
- [21] Colliat J. L., and Colliard D. Set-up of suction piles in deepwater Gulf of Guinea clays. *Frontiers in Offshore Geotechnics II: Proc., 2nd Int. Symp. on Frontiers in Offshore Geotechnics 2010*, Taylor & Francis Group, London.
- [22] Andersen, K. H., and Jostad, H. P. Shear strength along outside wall of suction anchors in clay after installation. *Proc., 12th Int. Offshore and Polar Engineering Conf. 2002, ISOPE, Kitakyushu, Japan*.
- [23] American Petroleum Institute. *API recommended practice for planning, designing and constructing fixed off-shore platforms*. Washington, DC: API; 1984.
- [24] NAVFAC DM 7.2. *Foundation and earth structures*. U.S. Department of the Navy; 1984.
- [25] American Petroleum Institute. *API Recommended practice for planning, designing, and constructing fixed offshore platforms-working stress design API Recommended practice 2A-WSD (RP 2A-WSD) twenty-first edition*. December 2000.
- [26] DNV-RP-E303–2005: det Norske Veritas. *Geotechnical design and installation of suction anchors in clay*. October 2005.
- [27] DNV-OS-J101–2007: det Norske Veritas. *Design of offshore wind turbine structures*. October 2007.
- [28] Kolk HJ, Van Der Velde A. A reliable method to determine friction capacity of piles driven into clays. *Proc. Offshore technological conference, vol. 2*. 1996. Houston, TX.
- [29] Karlsrud K, Clausen CJF, Aas PM. Bearing capacity of driven piles in clay, the NGI approach. *Proc. Int. Symp. on frontiers in offshore geotechnics, vol. 1*. 2005. p. 775–82. Perth.
- [30] Andersen, K. H., and Jostad, H. P. Shear strength along inside of suction anchor skirt wall in clay. *Offshore Technology Conf. 2004, OTC16844, OTC, Houston, Texas*.
- [31] Houlsby GT, Byrne BW. Design procedures for installation of suction caissons in clay and other materials. *Geotech Eng* 2005;158(2):75–82.
- [32] Tran MN, Randolph MF. Variation of suction pressure during caisson installation in sand. *Geotechnique* 2008;58(1):1–11.
- [33] Jeanjean, P., Znidarcic, D., Phillips, R., Ko, H. Y., Pfister, S., and Schroeder, K. Centrifuge testing on suction anchors: Doublewall, stiff clays, and layered soil profile. *Offshore Technology Conf. 2006, OTC 18007, OTC, Houston*.
- [34] Tran MN. *Installation of suction caissons in dense sand and the influence of silt and cemented layers* PhD. thesis Australia: Univ. of Sydney; 2005.
- [35] EI-Sherbiny RM. *Performance of bucket foundation anchors in normally consolidated clay* PhD. thesis USA: Univ. of Texas at Austin; 2005.
- [36] Huang J., Cao J. and Audibert J. M. E. Geotechnical design of bucket foundation in clay. In: *Proceedings of 13th international offshore and polar engineering conference 2003*. Honolulu, Hawaii, USA.