Closed Loop Start of Combustion Control Utilizing Ionization Sensing in a Diesel Engine

Magnus Glavmo, Peter Spadafora and Russell Bosch
Delphi Automotive Systems

Reprinted From: **Electronic Engine Control 1999: Neural Networks,
Diagnostic and Electronic Hardware, and Controls
(SP-14)**

The appearance of this ISSN code at the bottom of this page indicates SAE's consent that copies of the paper may be made for personal or internal use of specific clients. This consent is given on the condition, however, that the copier pay a \$7.00 per article copy fee through the Copyright Clearance Center, Inc. Operations Center, 222 Rosewood Drive, Danvers, MA 01923 for copying beyond that permitted by Sections 107 or 108 of the U.S. Copyright Law. This consent does not extend to other kinds of copying such as copying for general distribution, for advertising or promotional purposes, for creating new collective works, or for resale.

SAE routinely stocks printed papers for a period of three years following date of publication. Direct your orders to SAE Customer Sales and Satisfaction Department.

Quantity reprint rates can be obtained from the Customer Sales and Satisfaction Department.

To request permission to reprint a technical paper or permission to use copyrighted SAE publications in other works, contact the SAE Publications Group.



GLOBAL MOBILITY DATABASE

All SAE papers, standards, and selected books are abstracted and indexed in the Global Mobility Database

No part of this publication may be reproduced in any form, in an electronic retrieval system or otherwise, without the prior written permission of the publisher.

ISSN 0148-7191

Copyright 1999 Society of Automotive Engineers, Inc.

Positions and opinions advanced in this paper are those of the author(s) and not necessarily those of SAE. The author is solely responsible for the content of the paper. A process is available by which discussions will be printed with the paper if it is published in SAE Transactions. For permission to publish this paper in full or in part, contact the SAE Publications Group.

Persons wishing to submit papers to be considered for presentation or publication through SAE should send the manuscript or a 300 word abstract of a proposed manuscript to: Secretary, Engineering Meetings Board, SAE.

Printed in USA

Closed Loop Start of Combustion Control Utilizing Ionization Sensing in a Diesel Engine

Magnus Glavmo, Peter Spadafora and Russell Bosch
Delphi Automotive Systems

Copyright © 1999 Society of Automotive Engineers, Inc.

ABSTRACT

This paper describes the technique of in-cylinder ionization sensing in a common rail diesel engine. The technology detects in real time, the start of combustion for both pilot and main combustion enabling the fuel control strategy to change from open to closed loop, thus, maintaining the desired start of combustion for all speeds and loads. Additionally, the ionization sensing enables the ECM to truly correct for changes in ignition delays caused by as an example a change in fuel cetane number or in air, fuel and engine temperature. The conclusions are that ionization sensing improves the ability to control a diesel engine and is a feasible technology for production vehicles.

INTRODUCTION

To meet the stringent emission legislation of the future, high speed direct injection diesel engines will require higher fuel injection pressure and multiple injection events. Pilot injection or multiple pilot injections, will be used to reduce audible noise and NOx. Main injection with rate shaping will be used for torque pulse control. Post-injection will be used to supply HC for an active de-NOx catalytic converter. This requires a high precision fuel injection system. Today, the required precision is controlled by small mechanical tolerances in the injector, making the fuel injection system costly and difficult to produce.

BACKGROUND

Over the last few years, there has been an increasing interest in ionization sensing technique for spark ignition (SI) engines. Several papers have described the advantage of utilizing ionization sensing over crankshaft velocity fluctuation measurement for 100% misfire detection at all speeds and loads as required by OBD-2 [1][2]. This is especially the case for engines with more than 4 cylinders.

The detection of knock by using band-pass filtered ionization sensed data is also an established method [2]. Recent studies have also shown that the ionization sense signal can be used to predict the in-cylinder pressure [3][4][5] and the local air fuel ratio at the spark plug in SI-engines [6][7]. The application of ionization sensing technology in diesel engines has not been explored as well and only very few publications can be found.

To meet future diesel emission legislation a closed loop fuel delivery control will be required[8]. Today, production feasible technologies to monitor fuel deliveries are cylinder pressure and needle lift sensors. The disadvantages with needle lift sensors are cost, increased complexity and only the start of injection (SOI) and not the start of combustion (SOC) can be detected. SOC is the parameter which controls the performance and emissions of the engine.

Cylinder pressure sensors are also costly and have a drawback when pilot injection is used because it is difficult to extract both pilot and main combustion information in real time. This is quite troublesome since the trend is to reduce the pilot injection quantity to a minimum. A small pilot injection quantity is difficult to detect with the cylinder pressure signal. This paper proposes to use ionization sensing as a cost effective alternative for closed loop fuel delivery control.

IONIZATION SENSING TECHNOLOGY

BASIC THEORY – The combustion of fuel in the cylinder is basically a complex set of thousands of chemical reactions. What many of the chemical reactions have in common are that they produce free electrons by chemi-ionization. Chemi-ionization occurs during an exothermic reaction when the released reaction energy is large enough to ionize one of the reaction products[8]. The most important chemi-ionization reaction in flames has been found to be (1).

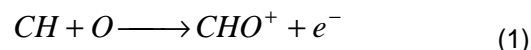

H_3O^+ is also another dominating ion. This ion is formed via a charge transfer reaction according to (2).

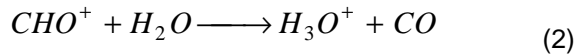

Since the reduction, reaction (2), is faster than the production, reaction (1), the concentration of H_3O^+ ions is much higher than of CHO^+ .

As the temperature rises in the combustion chamber, additional free electrons are produced by thermal ionization processes. This process can be described as in reaction (3), where M represents a generic molecule, M^+ is a generic positive ion, e^- is an electron and E_{ion} is the ionization energy.

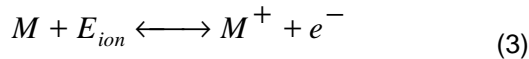

The ions produced by chemi-ionization and thermal ionization will after a short time recombine with an electron and form a more stable molecule. The ions have different recombination rates, some ions recombine quickly, while others have longer residual time. An example of a recombination process is shown in reaction (4) where the ion H_3O^+ produced by reaction (2) is removed by recombination with an electron to form water and a hydrogen atom.

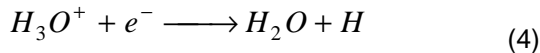

IONIZATION MEASUREMENT

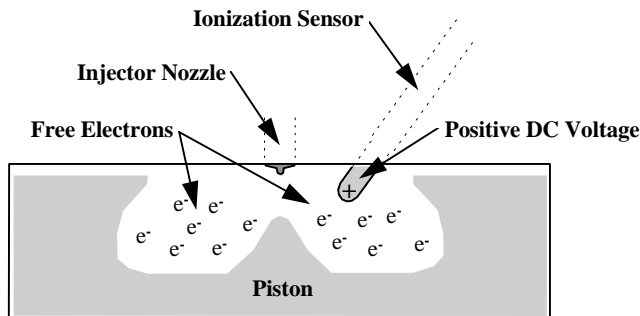

Figure 1. Free electrons produced by the combustion is the origin of ionization sensing technology.

By introducing a positive DC voltage inside the combustion chamber an electrical field is created, Figure 1. The electrical field will attract the negative charged species and a small current is generated from the sensor to electrical ground. The electrical ground is the piston and the combustion chamber walls. The current is traditionally called "ion current". However, this is a misleading name since even if the majority of the electrons are attached and only a minority are free [5] it is still the electrons that are responsible for most of the current due to their lower mass and therefore higher drift velocity [4][5][6].

IONIZATION SENSOR – In an SI-engine the DC voltage is applied after the ignition event to the existing spark plug, therefore the sensor and location are given. In a diesel engine, however, the ionization sensing device must be designed for the purpose. For this study a specially designed ionization sensing probe has been developed, Figure 2.

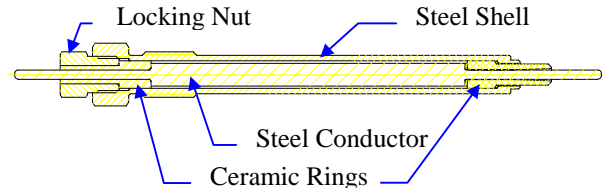

Figure 2. Ionization sensor used during the study.

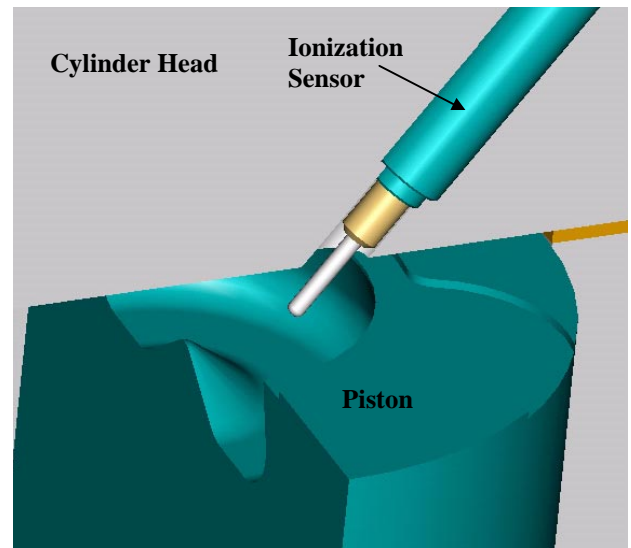

Figure 3. Schematic drawing of the ionization sensor mounting. (Cylinder head very schematically showed).

The design is simple, a metal core as the conductor, a metal shell, two ceramic rings to insulate the core from the metal shell and a locking nut. The sensor is designed to fit into a modified glow plug hole of the engine, Figure 3. The modification was made to the glow plug holes to enable in-cylinder pressure measurement with Kistler pressure sensors type 6123. For implementation in production vehicles, however, the only feasible alternative is to combine the ionization sensing function with the existing glow plug. The key benefits of combining the ionization function with the glow plug are that no engine modifications are required and also that the location of the glow plug is beneficial for sensing.

IONIZATION SIGNAL – The core part of the simple measurement circuit is shown in Figure 4. A capacitor is charged during the inactive period of the engine cycle to a voltage U. Before the combustion can theoretically take place, the voltage is applied to the ionization sensor

(steel conductor in Figure 2). During the combustion, a small current flows through the combustion chamber to engine electrical ground. The absolute current level depends on the sensor design and the sensor voltage but is generally in the order of 1 to 10 $\mu\text{A} / \text{V}$ (sensor voltage). The current is measured inside the engine control module (ECM) with a sense resistor, creating a voltage signal ΔV called ionization signal. This signal is proportional to the applied sensor voltage U and the ionization in the vicinity of the sensor.

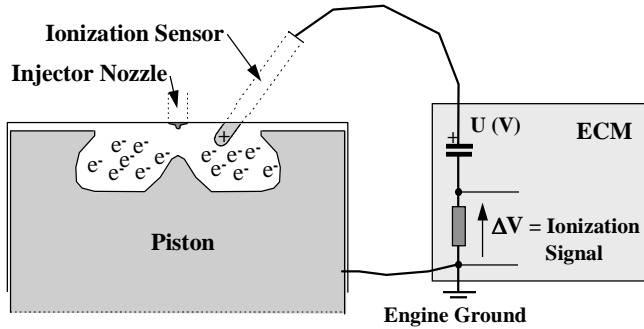

Figure 4. The core part of the ionization sense measurement circuit in a diesel engine

ENGINE DATA

MAIN COMBUSTION DETECTION – A study was performed on a 4 cylinder 2,0 liter direct injection common rail engine. Figure 5 - Figure 9 shows the in-cylinder pressure and ionization signal for three different injection timings at the same engine speed and load point. The ionization signal is the differential voltage output defined from the ionization current, Figure 4. SOIPLSM (Start Of Injection Pulse Main) is the crank angle for the start of the electrical pulse to the injector’s solenoid from the ECM. The difference in the SOIPLSM timing curves are always 2 crank angle degrees. The data was recorded in a steady state operation in an engine dynamometer. Since the ionization signal is measured locally in the combustion chamber the signal can vary from cycle to cycle. To minimize the influence of cycle to cycle variations, the data are averaged over 100 cycles.

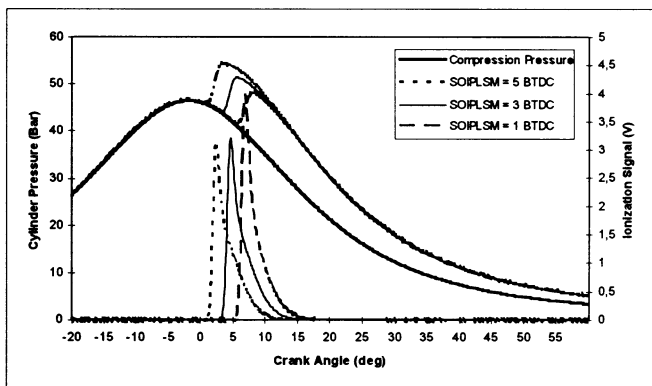

Figure 5. Idle speed, 800 rpm for 3 different injection timing. 2 crank angle degrees difference.

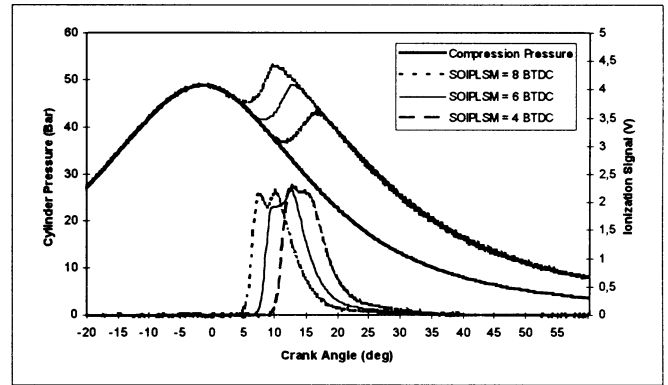

Figure 6. 1500 rpm, 32 Nm load for 3 different injection timings. 2 crank angle degrees difference.

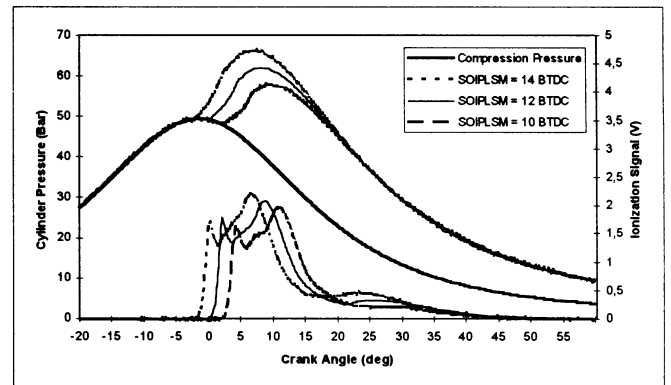

Figure 7. 1500 rpm, 64 Nm load for 3 different injection timings. 2 crank angle degrees difference.

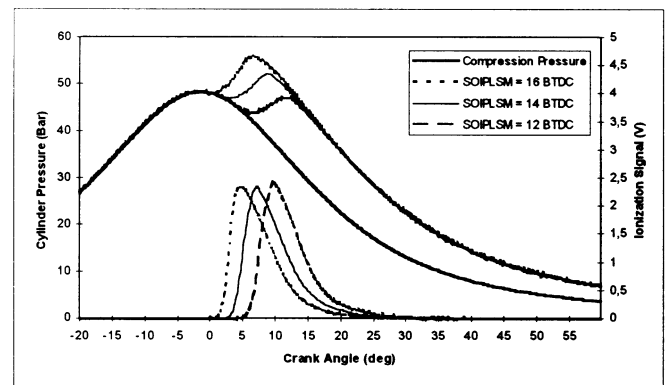

Figure 8. 2000 rpm, 16 Nm load for 3 different injection timings. 2 crank angle degrees difference.

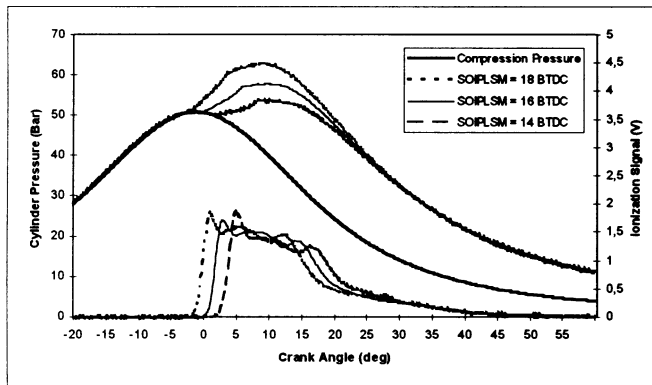

Figure 9. 2000 rpm, 80 Nm load for 3 different injection timings. 2 crank angle degrees difference.

PILOT COMBUSTION DETECTION – The developed ionization sensing system was also tested when pilot injection was employed. Figure 10 shows the in-cylinder pressure and ionization signal (as defined in Figure 4) for one measurement with no pilot injection and three measurements with different pilot injection quantities and timings. The main injection timing and the total injected quantity (pilot + main) is the same for all measurements. The timing is defined as the start of the electrical pulse from the ECM and all measurements are at the same engine speed and load point, 1500 rpm and 32 Nm load. The data shown is based on average data over 100 cycles.

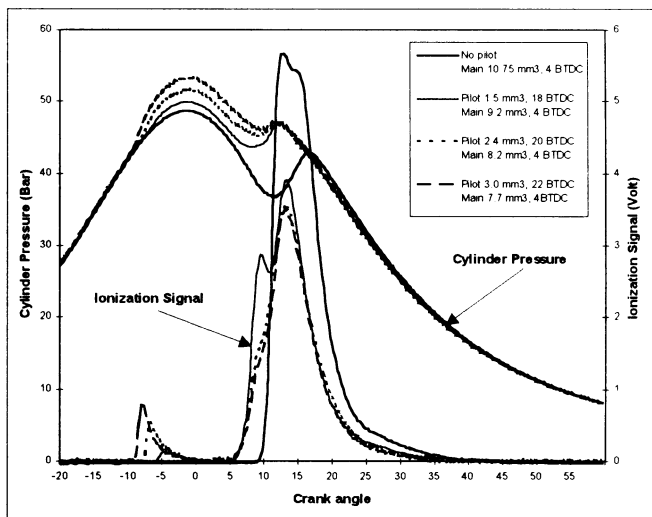

Figure 10. Rate of heat release and ionization signal for pilot and no pilot injection

Figure 11 shows the calculated rate of heat release and the ionization signal for the same comparison data as in Figure 10. As can be seen from these figures, the ionization signal can also be used to detect the start of combustion of the pilot injection.

During the study, a number of different pilot injection quantities ranging from 3 mm³ down to 0,6 mm³ were tested. A large variety of different pilot and main injection timings were also tested. The finding was that the ionization signal amplitude is dependent on both the injection quantity and timing.

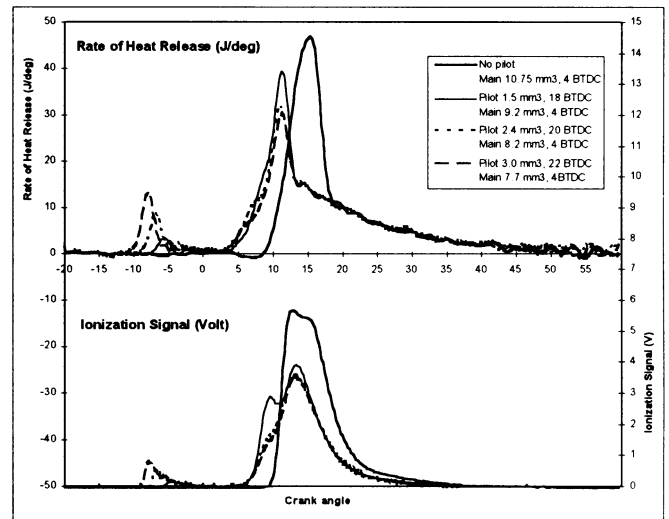

Figure 11. Ionization signal for with and without pilot injection at 1500 rpm, 32 Nm load.

The minimum detectable quantity depends on many different properties such as the engine design, engine speed and load, coolant temperature, air temperature, fuel quality but most of all the injection timing. Figure 12 illustrates the ionization signal dependence on injection timing.

To minimize the influence of cycle to cycle variations the curves are average data over 100 cycles. At this condition the maximum amplitude was achieved at the start of combustion timing around 5 degrees BTDC. As the timing was more advanced or retarded the amplitude decreases due to the lowering of the combustion temperature.

The injections shown in Figure 12 were made without any main injection and consequently the combustion chamber temperature was much lower than normal. During the study, much smaller pilot injection quantities and more advanced timings were detected than shown in Figure 12.

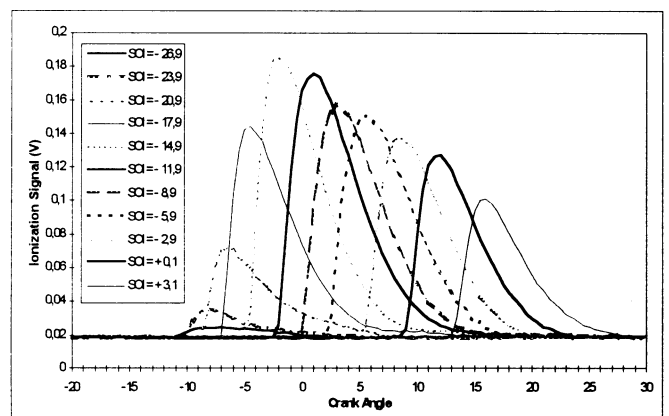

Figure 12. Ionization signal for different injection timing at 1200 rpm and fixed pilot quantity at 2,5 mm³. 3 crank angle degrees between the curves.

CLOSED LOOP INJECTION TIMING CONTROL

IONIZATION SENSED START OF COMBUSTION – The difference in ionization signal before the combustion and after combustion has started is quite pronounced Figure 5 - Figure 9. This makes ionization sensing suitable for start of combustion detection. By utilizing ionization sensing the fuel control strategy can be changed from open to closed loop, thus, maintaining the desired start of combustion for all speeds and loads.

START OF COMBUSTION DETERMINATION – The start of combustion crank angle position detected by ionization sensing is defined as the moment when the first derivative of the ionization signal passes a pre-defined threshold level, Figure 13. To obtain a fast and precise detection the threshold level must be set as close to zero as practically possible. However, since a derivative signal is noise sensitive, the signal must first be passed through a low pass filter to minimize the risk of false detection.

What does the ionization signal based SOC mean? In theory, the production of free electrons starts when the combustion begins. In practice, the detection is somewhat delayed by the need for a sufficient change in signal and some delay in the electronic circuit. In comparison with the SOC determined by the derivative of the cylinder pressure or rate of heat release the ionization SOC detection is up to a few crank angle degrees later. This angle difference between SOC detection techniques are engine speed and load dependent. The delay itself does not have any negative impact of the performance of the closed loop injection timing control. It is important to keep in mind that for applications in production, it is not necessary to detect the physically correct SOC but to detect a combustion timing event that is robust and repeatable across all cylinders and engines. The goal is to eliminate the part to part variations in the fuel injection system and to maintain the performance of the engine. The ionization sensed SOC detection is capable of meeting these requirements.

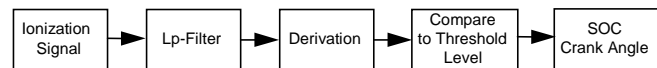

Figure 13. Definition of ionization sensed SOC detection.

TIMING CONTROL STRATEGY

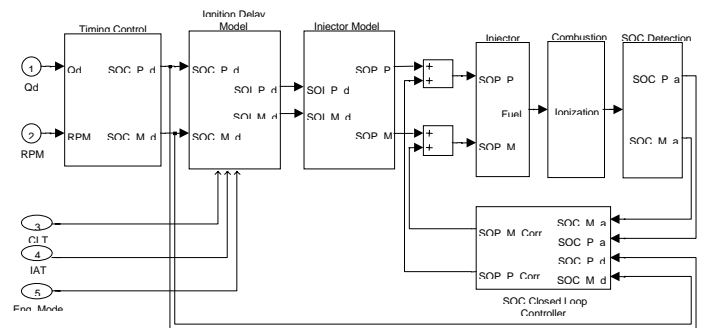

Figure 14. Timing control strategy for ionization sensed closed loop start of combustion control.

A benefit of moving to a start of combustion based closed loop system is that it enables the system developer to apply a straight forward approach based on a physical model. Additionally, the start of combustion detection enables the ECM to correct for changes in ignition delays; such as, fuel cetane number and changes in air, fuel and engine temperature. Figure 14 shows an example of an ionization based closed loop injection timing control strategy. The timing control is cylinder individual and compensates for injector to injector timing tolerances. The desired SOC timing is determined primarily on engine speed and load. The start of electrical pulse to the injectors is corrected based on the difference between the desired and a running average of the actual SOC.

EGR

The use of exhaust gas re-circulation, EGR is another key technology to meet future emission legislation. The purpose of EGR is to lower the combustion temperature in order to lower the rate of formation of NOx. The use of EGR will therefore lower the ionization rate and consequently the amplitude of the ionization signal.

Figure 15 shows the impact of EGR on the ionization signal. Four different EGR measurements were conducted with one measurement at 0 EGR. All four measurements are recorded at the identical speed and load point (1500 rpm, 32 Nm). As can be seen from Figure 15, increasing EGR valve opening reduces the ionization signal amplitude and consequently the integral of the signal. For the study the EGR rate was defined by the calibration of the engine to meet EURO III emission legislation. The lowering of the ionization signal amplitude due to EGR did however not affect the ability to detect the start of combustion.

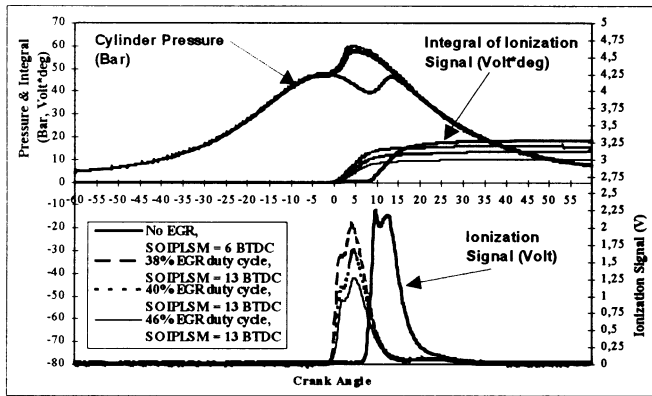

Figure 15. Comparison between no EGR and 3 different EGR valve duty cycles at 1500 rpm, 32 Nm.

SOOT CONTAMINATION

Increasing use of EGR can increase soot production in the combustion chamber. One of the potential problems for the ionization sensing technique is that soot could cover the sensor. The soot is conductive and can, if excessive, lead to a lowering of the resistance from the ionization sensing element to electrical ground, Figure 16.

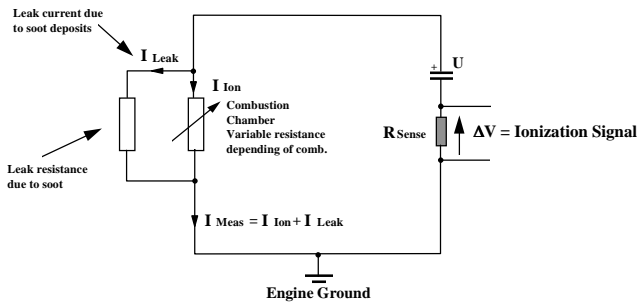

Figure 16. Leak current caused by soot.

This problem has to be taken into consideration at the design of the sensor since, undoubtedly, the sensor will be covered with soot and it is difficult to prevent the soot from attaching the probe. Making the path between the sensing element to electrical ground as long as possible is one precaution to be taken when the ionization sensing system is designed.

An additional advantage of combining the ionization sensing function with the glow plug is that it allows the possibility for self cleaning. One control scheme involves measuring the resistance between the sensor to electrical ground before combustion takes place. If the resistance is below a predefined value the glow plugs are activated and the soot is burned off the sensor. This can be done while the engine is running without any loss of SOC detection. After the glowing has been activated for a time the glow plugs are de-activated and the resistance is measured again to see if the sensor is cleaned.

DIAGNOSTICS

The ionization sensing technique which provides a real time combustion feedback increases the diagnosing ability of the system. The measurement of ionization sensing enables the following diagnostic features:

- Misfire detection
- Injector stuck open
- Close loop combustion timing too early
- Close loop combustion timing too late

The failure modes that can be detected by these diagnostics include the following:

- Incorrect fuel: such as gasoline, kerosene
- No combustion in cylinder: Injector stuck closed, fuel leaks, flow limiter restriction
- Excessive combustion or combustion starting too early: Injector stuck open or leaking inside combustion chamber
- Excessive variation in the fuel injection system components (injector, sensors, ECM etc.)

SUMMARY

The technique of in-cylinder ionization sensing in a common rail diesel engine has been described. The technology detects in real time for every engine cycle and for every cylinder the start of combustion. A design of a simple ionization sensor was presented. For production applications it is suggested that the ionization feature be combined with the glow plug. The main reasons are the favorable sensor location and the ability to "self clean" the sensor from soot deposits by heating. Engine data from a 2,0 liter common rail engine has shown that ionization sensing is capable of detecting the start of combustion for both pilot and main combustion. A definition of how to extract the SOC information from the ionization signal was presented and a possible closed loop injection timing control strategy was exemplified. The lowering of the ionization signal amplitude due to the lowering of combustion temperature caused by EGR was discussed. The importance of designing the ionization sensing system to withstand soot particles covering the sensor was also stated. Finally a summary of ionization sensing capability to improve diagnosis the fuel injection system was provided.

CONCLUSIONS

The requirements for fuel injection systems on diesel engines are extremely challenging, this is especially the case for the need of a small and precise pilot injection. The ionization sensing technique shows a large potential to contribute to meeting these requirements and improve the ability to control a diesel engine.

The ionization measurement and the determination of SOC are simple and straight forward. To design a probe that can survive during a limited number of hours in a research program is not so difficult. For implementation in production engines an alternative is to combine the ionization sensing feature with the already existing glow plug, mainly due to its location but also for its ability to "self clean" the sensor from soot deposits. Undoubtedly, for a successful implementation of an ionization sensing system in production vehicles the soot contamination of the sensor must be taken into consideration in the system design.

Engine data shows that ionization sensing can be used for real time detection of the start of combustion for both pilot and main combustion. Furthermore, ionization sensing enables the fuel control strategy to transform from open to closed loop operation, thus maintaining the desired start of combustion for all speeds and loads. The SOC detection also enables the ECM to correct for changes in ignition delays; such as, fuel cetane level and changes in air, fuel and engine temperature.

The use of EGR will lower the ionization signal amplitude. With increasing EGR the amplitude will decrease due to the lowering of combustion temperature. In our study, performed on an engine meeting EURO III emission legislation, the decrease in signal amplitude was not to such an extent that the information was lost.

Thanks to the direct combustion feedback, ionization sensing provides the ability to diagnose the fuel injection system as will be required by future OBD.

The overall conclusion is that ionization sensing is a feasible technology for production diesel engines and a cost effective alternative for performing closed loop fuel control .

ACKNOWLEDGMENTS

The authors would like to thank the Delphi Diesel Team in Luxembourg for all support during this study and Mecel AB in Sweden for all support during the development of the ionization sensing system.

REFERENCES

1. Lee, Anson and Jan S. Pyko, "Engine Misfire Detection by Ionization Current Monitoring", SAE Paper 950003
2. Auzins, J., Johansson H. and Nytomt J., "Ion-Gap Sense in Misfire Detection, Knock and Engine Control", SAE Paper 950004
3. Eriksson, L., Nielsen, L. and Nytomt, J., "Ignition Control by Ionization Current Interpretation", SAE Paper 960045
4. Saitzkoff, A., Reinmann, R., Berglind, T. and Glavmo, M., "An Ionization Equilibrium Analysis of the Spark Plug as an Ionization Sensor", SAE Paper 960337
5. Saitzkoff, A., Reinmann, R., Mauss, F. and Glavmo, M., "In-Cylinder Pressure Measurements Using the Spark Plug as Ionization Sensor", SAE Paper 970857
6. Reinmann, R., Saitzkoff, A., Mauss, F. and Glavmo, M., "Local Air-Fuel Ratio Measurements Using the Spark Plug as Ionization Sensor", SAE Paper 970856
7. Balles, E., et al., "In-Cylinder Air/Fuel Ratio Approximation Using Spark Gap Ionization Sensing", SAE Paper 980166.
8. Reinmann, R., Saitzkoff, A., Lassesson, B., Strandh, P., "Fuel and Additive Influence on the Ion Current", SAE Paper 980161.

DEFINITIONS, ACRONYMS, ABBREVIATIONS

BTDC: Before Top Dead Center

ECM: Engine Control Module

EGR: Exhaust Gas Re-circulation

EMS: Engine Management System

EOBD: European On Board Diagnostics

EURO III: The third phase of European emission legislation from year 2000

OBD: On Board Diagnostics

SOC: Start Of Combustion

SOI: Start Of Injection

SOIPLSM: Start Of Injection PuLSe Main: The start of the electrical pulse to the injector solenoid for the main fuel injection.