

# Analysis of Leakage Flux in Large Transformer by Using Field-Circuit Coupled Finite Element Method

Guohua Ding

School of Science, Shenyang Ligong University  
Shenyang, China  
dgh2010ei@sina.cn

**Abstract**—A power transformer operating in electric network is supplied by voltage source. When analyzing leakage flux and magnetic forces of the power transformer applied to windings, the field-circuit coupled 3D finite element method is needed because of the drawbacks of magnetic dipole model and 2D finite element method. The models were used for simulating and analyzing leakage flux and magnetic forces data sets. It is the base for further studying on magnetic flux leakage and magnetic forces inspection.

**Keywords**- Power transformer, field- circuit coupled finite element method, leakage flux, magnetic force

## I. INTRODUCTION

Circuit124 is a general circuit element applicable to circuit simulation. The element may also interface with electromagnetic finite elements to simulate coupled electromagnetic-circuit field interaction. The element has up to 6 nodes to define the circuit component and up to three degrees of freedom per node to model the circuit response. For electromagnetic-circuit field coupling, the element may interface with solid97, the 3-D electromagnetic field elements. Circuit124 is applicable to static, harmonic, and transient analyses. This option couples an electric circuit to field of a stranded coil in a 3-D finite element model[1,2].

## II. THE FIELD-CIRCUIT COUPLED MODEL

A power transformer operating in electric network is supplied by voltage source. When analyzing forces applied to coils, the field-circuit coupled method is needed[3,4]. The field-circuit coupled model transformer is given in Fig. 1.

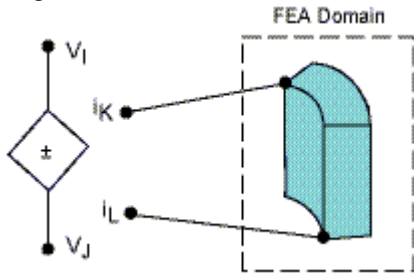

Figure 1. Field circuit finite element mesh model.

The input and output to concentrate on the equivalent

in ANSYS. Coil regions separated by the partition of the finite element solution. This method can be called the field-circuit coupled finite element method[5]. The equation couples the finite element electromagnetic field with the electrical circuit as follows:

$$u(t) = Ri(t) + L \frac{di(t)}{dt} + e(t) \quad (1)$$

Where  $\{e\}$  is nodal electromotive force drop (EMF),  $[K^{ie}]$  is current-emf coupling stiffness, then  $[K^{AA}]$ ,  $[C^{iA}]$  can be derived and substituting them into (2)

$$e(t) = -\frac{d\Psi(t)}{dt} = \frac{d}{dt} \int_V \mu \mathbf{K}_J \cdot (\mathbf{T}_0 + \mathbf{T} - \nabla \Omega) dv \quad (2)$$

By using this method, we can obtain  $\mathbf{A}$ , using the vector potential  $\mathbf{A}$ , the magnetic flux density  $\mathbf{B}$  and current density  $\mathbf{J}$  is generally solved.

$$\{B\} = \nabla \times [N_i]^T \{A_e\} \quad (3)$$

$[N_i]$  is shape function matrix,  $\{A_e\}$  is node vector potential.

$$N_i = \frac{1}{8}(1 + \xi_i \zeta_i)(1 + \eta_i \eta_i)(1 + \varsigma_i \varsigma_i) \quad (i = 1, 2, \dots, 8) \quad (4)$$

$\xi_i, \eta_i, \varsigma_i$  is hexahedron element acme of local coordinate numerical value.

$\varsigma_i$  is the hexahedral element is the vertex of the local coordinates as in

$$(\xi_i, \eta_i, \varsigma_i) = \begin{cases} (-1, -1, -1) & i = 1 \\ (1, -1, -1) & i = 2 \\ (1, 1, -1) & i = 3 \\ (-1, 1, -1) & i = 4 \\ (-1, -1, 1) & i = 5 \\ (1, -1, 1) & i = 6 \\ (1, 1, 1) & i = 7 \\ (-1, 1, 1) & i = 8 \end{cases} \quad (5)$$

Magnetic field strength  $\{H\}$  can be calculated by Magnetic flux density

$$\{H\} = [v]\{B\} \quad (6)$$

Where  $[v]$  is reluctance rate matrix.

current density component cause by Magnetic vector spaces  $\{A\}$  is discribed in (5)

$$\{J_e\} = -[\sigma] \left\{ \frac{\partial A}{\partial t} \right\} = -[\sigma] \frac{1}{n} \sum_{i=1}^n [N_A]^T \{A_e\} \quad (7)$$

With the magnetic flux density  $B$  and current density

$J$ .

Maxwell stress tensor is obtained from Maxwell equations. The force is equal to the surface integral of the Maxwell stress tensor as follows

$$\{F^{mx}\} = \frac{1}{2\mu_0} \int \left[ Re \left( \hat{n} \cdot \{B\}^* \right) \{B\} - \frac{1}{2} (\{B\} \cdot \{B\}^*) \hat{n} \right] ds \quad (8)$$

Magnetic analysis is carried out by creating the physical environment, meshing the model, determining the physical properties of each region, applying the boundary conditions, solving the problem and deriving the results. Magnetic force computation is carried out by creating the physical environment, meshing the model, determining the physical properties of each region, applying the boundary conditions.

Electromagnetic force is computed as follows

$$\{F\} = \int_V \{N\}^T (\{J\} \times \{B\}) dV \quad (9)$$

$\{B\}$  is the magnetic flux density,  $\{J\}$  is current density  
The numerical simulation is taken by ANSYS software

### III. THE NUMERICAL SIMULATION BY ANSYS SOFEWARE

Numerical simulation is taken by ANSYS Sofeware on power transformer, sspl-260000/220 power transformer as an example, parameter of power transformer is shown as table I.

TABLE I. PARAMETERS OF POWER TRANSFORMER WINDINGS

|    | inner diameter (mm) | external diameter (mm) | windows turns | Phase High (mm) | Phase current (A) |
|----|---------------------|------------------------|---------------|-----------------|-------------------|
| HV | 2044                | 2384                   | 508           | 2050            | 755.8             |
| LV | 1574                | 1824                   | 32            | 2080            | 12000             |

Based on the above parameters, the power transformer model of calculation is built. It is shown in Fig.2.

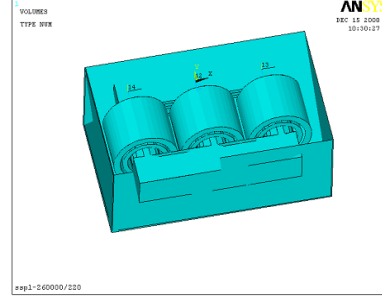

Figure 2. The power transformer model

For Analysis of leakage flux and magnetic forces, Three-dimensional time unit must be No. solid97, The key element of the first option set to No. 3, it mains wire loop power supply circuit, Analysis model in the way of the circuit unit No. circu124, The first option when the key is set to No. 5, it mains three-dimensional wire coil unit, when these types of circuit modules with the field set up unit in line and after sharing some nodes, that is, the realization of three-dimensional field-circuit coupling finite element method. Because of symmetry considerations, only one fourth of the transformer has been modeled. It is shown in Fig.3.

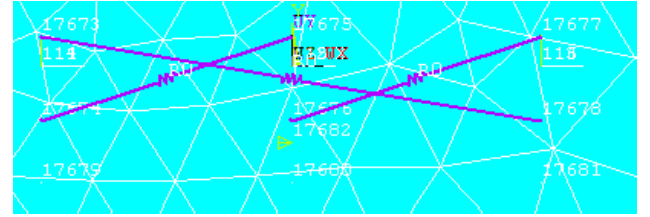

Figure 3. Field-circuit coupled model of finite element

#### A. Triangle Connection.

Volt input are discribed in (10).

$$U = 20000 \sin(100\pi t + \Phi) \quad (10)$$

While the original circuit unit 124, using the original side of the standard wire loop to connect current source coupled with the winding, Secondary side only with the standard wire loop current source connected to and become a triangle connection. Magnetic field of one-half core model is obtained, it is shown in Fig.4.

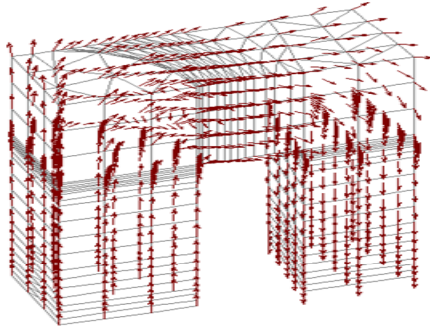

Figure 4. Magnetic field of one-half core model

The leakage flux of one-fourth windings model is obtained, it is shown in Fig.5. It can be seen that the leakage flux have a three dimensional aspect.

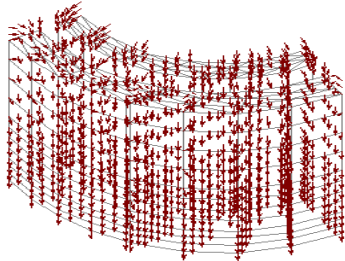

Figure 5. Leakage flux of one-fourth windings

### B. Meshing

Solid97 is used as a meshing unit, solid97 unit is No. 6 to 8-node plane element, Use of body surface with the adjacent unit on the winding Swept to mesh, Core and tank of transformer oil and free mesh generation of tetrahedral units.

### C. Solution

Since the core non-linear does not take into account and Sinusoidal input voltage therefore the use of transient analysis. all current are shown in Fig.4.

Solution results that primary current is about 754.6A, secondary current is 12008A, they consistent with calculation primary current 755.8A, secondary current is 12000A.

## IV. ANALYSIS AND COMPUTATION LEAKAGE FLUX AND MAGNETIC FORCE

Transformer simulation, primary windings are subject to significant radial pressure, secondary windings are subject to the tension of the radial, they are very small in the axial pressure or tension, this is because the iron hearts of the magnetic field almost parallel to the axis, inner windings of leakage flux are shown in Fig. 6.

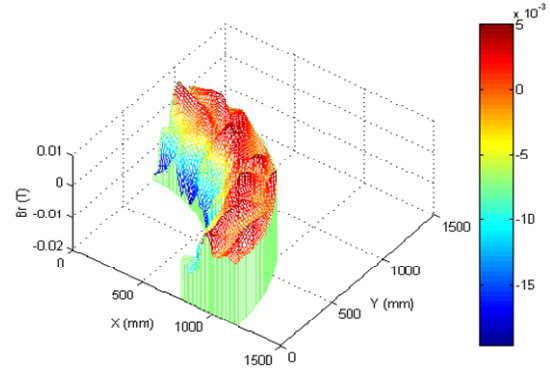

Figure 6. Inner windings of leakage flux

The simulation results illustrate that it exists press force in radial direction of inner coil, and extension force in radial direction of outer coil. There is little electro dynamic force in axis direction of both inner and outer coils. external windings of leakage flux are shown in Fig. 7.

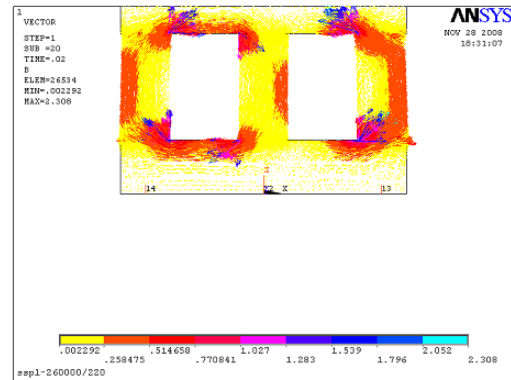

Figure 7. Leakage flux of one-fourth windings

According to distribution of leakage flux, axial magnetic force can calculate, it is shown in Fig.8.

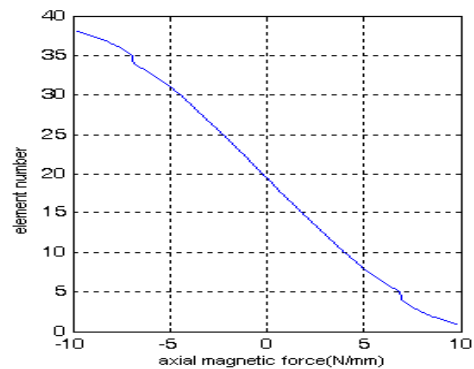

Figure 8. Distribution of axial magnetic force

Radial magnetic force can calculate, it is shown in Fig.9.

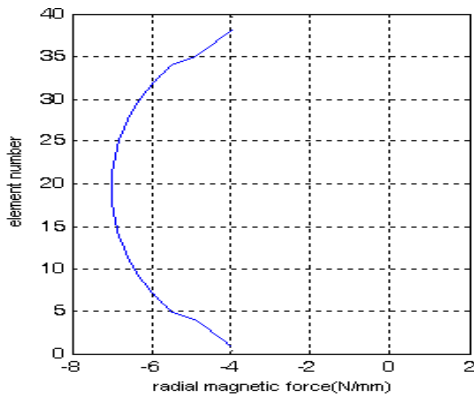

Figure 9. Distribution of radial magnetic force

## V. CONCLUSIONS

In this paper, the validity of this method was confirmed when it was applied to simulate the transformer. The use of circuit - magnetic field coupling finite element method can accurately simulate the power transformer open, normal and short-circuit situation, this is the design of large power transformers, fault diagnosis are of great significance, it is the base for further studying on leakage flux and magnetic forces inspection.

## REFERENCES

- [1] Tsukerman I A, Konrad A, Meumier G, et al. "Coupled field-circuit problem: trends and accomplishments," IEEE Trans on Magnetics, Vol.29, NO. 2, pp. 1701- 1704, 1993.
- [2] R. Y. Tang , S. H. Wang, and Y. Li, "Transient simulation of power transformers using 3D finite of power transformers using 3D finite element model coupled to electric circuit equations," IEEE Trans on Magnetics, Vol. 36, NO. 4, pp. 1417- 1420, 2000.
- [3] Bouissou S, Piriou F. Numerical simulation of a power transformer using 3D finite element method coupled to circuit equation. IEEE Trans on Magnetics, 1994, Vol.5, pp .3224-3227
- [4] Z. G. Liang , R. Y. Tang , C. C. Wang , Study of power transformers using 3D finite elementmodel coupled to electric circuit equations. In:Proceedings of the 4th International Conference on Electromagnetic Field Problems and Applications.Tianjin, China. 2000. Beijing: International Academic Publishers, 2000, pp.279-281
- [5] Lee J Y, Lee S J, Jiles D C, et al. "Sensitivity analysis of simulations for magnetic particle inspection using the finite-element Method". IEEE Transactions on Magnetics, Vol.39 pp .3604-3606, 2003.