

DEVELOPMENT OF SEISMIC VULNERABILITY ASSESSMENT METHODOLOGIES OVER THE PAST 30 YEARS

G.M. Calvi*, R. Pinho**, G. Magenes*, J.J. Bommer***, L.F. Restrepo-Vélez**** and H. Crowley**

*Department of Structural Mechanics, University of Pavia, Pavia, Italy

**European Centre for Training and Research in Earthquake Engineering (EUCENTRE), Pavia, Italy

***Department of Civil and Environmental Engineering, Imperial College London, U.K.

****Solingral S.A., Medellin, Colombia

ABSTRACT

Models capable of estimating losses in future earthquakes are of fundamental importance for emergency planners and for the insurance and reinsurance industries. One of the main ingredients in a loss model is an accurate, transparent and conceptually sound algorithm to assess the seismic vulnerability of the building stock and indeed many tools and methodologies have been proposed over the past 30 years for this purpose. This paper takes a look at some of the most significant contributions in the field of vulnerability assessment and identifies the key advantages and disadvantages of these procedures in order to distinguish the main characteristics of an ideal methodology.

KEYWORDS: Vulnerability Assessment, Loss Estimation, Unreinforced Masonry, Reinforced Concrete

INTRODUCTION

In the last few decades, a dramatic increase in the losses caused by natural catastrophes has been observed worldwide. Reasons for the increased losses are manifold, though these certainly include the increase in world population, the development of new “super-cities” (with a population greater than 2 million), many of which are located in zones of high seismic hazard, and the high vulnerability of modern societies and technologies (e.g., Smolka et al., 2004). The 1994 Northridge (California, US) earthquake produced the highest ever insured earthquake loss at approximately US\$14 billion, and the US\$150 billion cost of the 1995 Kobe (Japan) earthquake was the highest ever absolute earthquake loss. Although the dollar value of economic losses in other parts of the world may be far lower than in Japan and the US, the impact on the national economy may be much greater due to losses being a larger proportion of the gross national product (GNP) in that year. Coburn and Spence (2002) report the economic losses due to earthquakes from 1972 to 1990; the three largest losses as proportions of the GNP are in the Central American countries of Nicaragua (1972, 40% GNP), Guatemala (1976, 18% GNP) and El Salvador (1986, 31% GNP). When the economic burden falls entirely on the government (such as occurred after the 1999 Kocaeli earthquake in Turkey), the impact on the national economy can be crippling; one possible solution is to privatise the risk by offering insurance to homeowners and then to export large parts of the risk to the world’s reinsurance markets (e.g., Bommer et al., 2002). In order to design such insurance and reinsurance schemes, a reliable earthquake loss model for the region under consideration needs to be compiled such that the future losses due to earthquakes can be determined with relative accuracy.

The formulation of an earthquake loss model for a given region is not only of interest for predicting the economic impact of future earthquakes, but can also be of importance for risk mitigation. A loss model that allows the damage to the built environment and important lifelines to be predicted for a given scenario (perhaps the repetition of a significant historical earthquake) can be particularly important for emergency response and disaster planning by a national authority. Additionally, the model can be used to mitigate risk through the calibration of seismic codes for the design of new buildings; the additional cost in providing seismic resistance can be quantitatively compared with the potential losses that are subsequently avoided. Furthermore, the loss model can be used to design retrofitting schemes by carrying out cost/benefit studies for different types of structural intervention schemes.

Earthquake loss models should, ideally, include all of the possible hazards from earthquakes: amplified ground shaking, landslides, liquefaction, surface fault rupture, and tsunamis. Nevertheless,

strong ground shaking is often the only hazard considered in loss assessment methods; this is commonly an acceptable approach because as the size of the loss model increases, the relative influence of the secondary hazards such as liquefaction and landslides decreases (Bird and Bommer, 2004). Constructing an earthquake loss model for a city, region or country involves compiling databases of earthquake activity, ground conditions, ground-motion prediction equations, building stock and infrastructure exposure, and vulnerability characteristics of the exposed inventory. The main aim of a loss model is to calculate the seismic hazard at all the sites of interest and to convolve this hazard with the vulnerability of the exposed building stock such that the damage distribution of the building stock can be predicted; damage ratios, which relate the cost of repair and replacement to the cost of demolition and replacement of the structures, can then be used to calculate the loss.

A significant component of a loss model is a methodology to assess the vulnerability of the built environment. The seismic vulnerability of a structure can be described as its susceptibility to damage by ground shaking of a given intensity. The aim of a vulnerability assessment is to obtain the probability of a given level of damage to a given building type due to a scenario earthquake. The various methods for vulnerability assessment that have been proposed in the past for use in loss estimation can be divided into two main categories: empirical or analytical, both of which can be used in hybrid methods (see Figure 1).

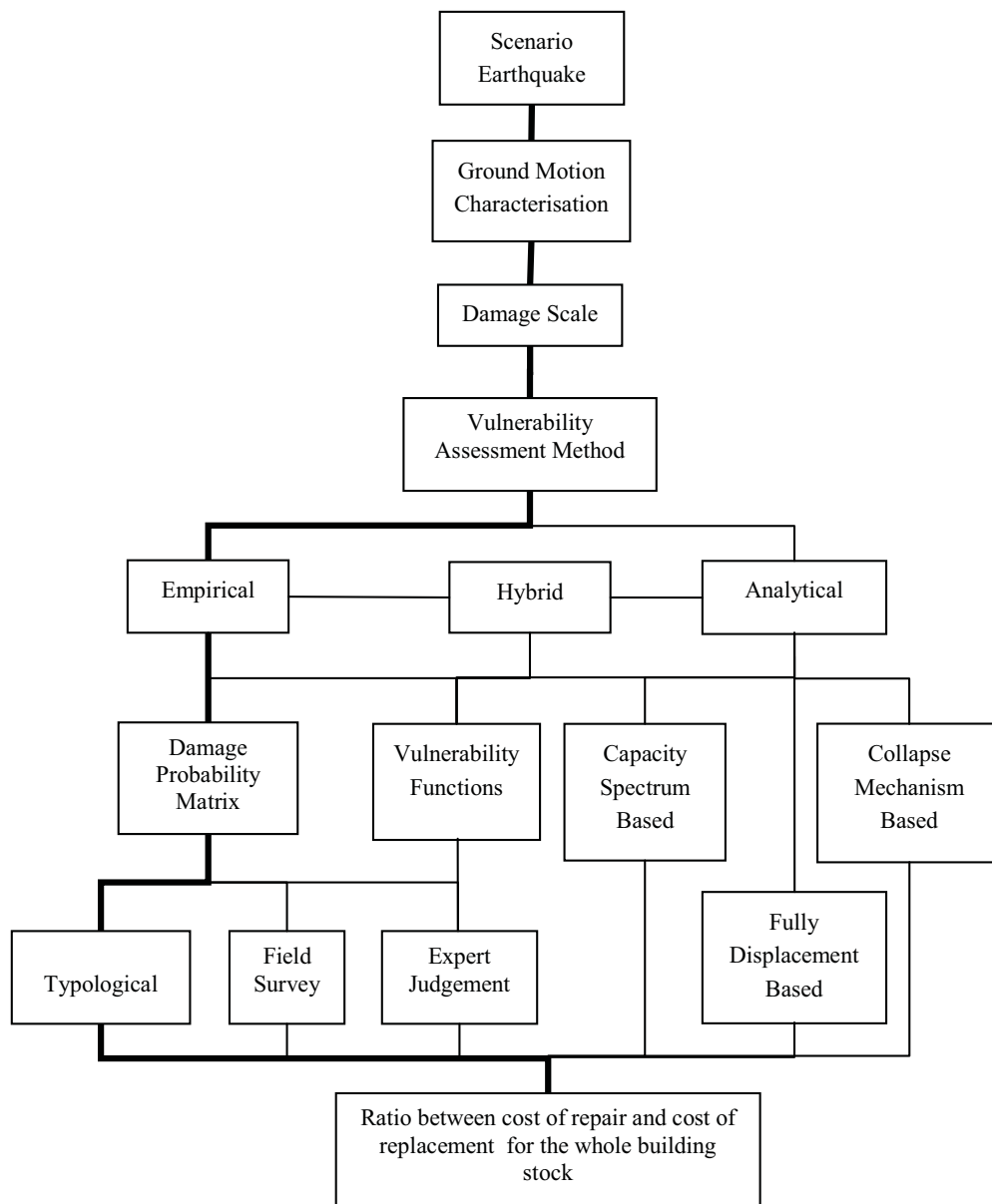

Fig. 1 The components of seismic risk assessment and choices for the vulnerability assessment procedure; the bold path shows a traditional assessment method

A vulnerability assessment needs to be made for a particular characterisation of the ground motion, which will represent the seismic demand of the earthquake on the building. The selected parameter should be able to correlate the ground motion with the damage to the buildings. Traditionally, macroseismic intensity and peak ground acceleration (PGA) have been used, whilst more recent proposals have linked the seismic vulnerability of the buildings to response spectra obtained from the ground motions.

Each vulnerability assessment method models the damage on a discrete damage scale; frequently used examples include the MSK scale (Medvedev and Sponheuer, 1969), the Modified Mercalli scale (Wood and Neumann, 1931) and the EMS98 scale (Grünthal, 1998). In empirical vulnerability procedures, the damage scale is used in reconnaissance efforts to produce post-earthquake damage statistics, whilst in analytical procedures this is related to limit-state mechanical properties of the buildings, such as inter-storey drift capacity.

The evolution of vulnerability assessment procedures for both individual buildings and building classes is described in the following sections, wherein the most important references, applications and developments pertaining to each methodology are reported. A larger emphasis has been placed on the vulnerability assessment of the built environment at an urban scale for use in risk and loss assessment methodologies.

EMPIRICAL METHODS

As described below, the seismic vulnerability assessment of buildings at large geographical scales has been first carried out in the early 70's, through the employment of empirical methods initially developed and calibrated as a function of macroseismic intensities. This came as a result of the fact that, at the time, hazard maps were, in their vast majority, defined in terms of these discrete damage scales (earlier attempts to correlate intensity to physical quantities, such as PGA, led to unacceptably large scatter). Therefore these empirical approaches constituted the only reasonable and possible approaches that could be initially employed in seismic risk analyses at a large scale.

There are two main types of empirical methods for the seismic vulnerability assessment of buildings that are based on the damage observed after earthquakes, both of which can be termed "damage-motion relationships": 1) damage probability matrices (DPM), which express in a discrete form the conditional probability of obtaining a damage level j , due to a ground motion of intensity i , $P[D = j | i]$; and 2) vulnerability functions, which are continuous functions expressing the probability of exceeding a given damage state, given a function of the earthquake intensity.

1. Damage Probability Matrices

Whitman et al. (1973) first proposed the use of damage probability matrices for the probabilistic prediction of damage to buildings from earthquakes. The concept of a DPM is that a given structural typology will have the same probability of being in a given damage state for a given earthquake intensity. The format of the DPM suggested by Whitman et al. (1973) is presented in Table 1, where example proportions of buildings with a given level of structural and non-structural damage are provided as a function of intensity (note that the damage ratio represents the ratio of cost of repair to cost of replacement). Whitman et al. (1973) compiled DPMs for various structural typologies according to the damage sustained in over 1600 buildings after the 1971 San Fernando earthquake.

One of the first European versions of a damage probability matrix was produced by Braga et al. (1982), which was based on the damage data of Italian buildings after the 1980 Irpinia earthquake, and this introduced the binomial distribution to describe the damage distributions of any class for different seismic intensities. The binomial distribution has the advantage of needing one parameter only which ranges between 0 and 1. On the other hand it has the disadvantage of having both mean and standard deviation depending on this unique parameter. The buildings were separated into three vulnerability classes (A, B and C) and a DPM based on the MSK scale was evaluated for each class. This type of method has also been termed 'direct' (Corsanego and Petrini, 1990) because there is a direct relationship between the building typology and observed damage. The use of DPMs is still popular in Italy and proposals have recently been made to update the original DPMs of Braga et al. (1982). Di Pasquale et al. (2005) have changed the DPMs from the MSK scale to the MCS (Mercalli-Cancani-Sieberg) scale because the Italian seismic catalogue is mainly based on this intensity, and the number of buildings has

been replaced by the number of dwellings so that the matrices could be used in conjunction with the 1991 Italian National Statistical Office (ISTAT) data. Dolce et al. (2003) have also adapted the original matrices as part of the ENSeRVES (European Network on Seismic Risk, Vulnerability and Earthquake Scenarios) project for the town of Potenza, Italy. An additional vulnerability class D has been included, using the EMS98 scale (Grüntal, 1998), to account for the buildings that have been constructed since 1980. These buildings should have a lower vulnerability as they have either been retrofitted or designed to comply with recent seismic codes.

Table 1: Format of the Damage Probability Matrix Proposed by Whitman et al. (1973)

Damage State	Structural Damage	Non-structural Damage	Damage Ratio (%)	Intensity of Earthquake				
				V	VI	VII	VIII	IX
0	None	None	0-0.05	10.4	-	-	-	-
1	None	Minor	0.05-0.3	16.4	0.5	-	-	-
2	None	Localised	0.3-1.25	40.0	22.5	-	-	-
3	Not noticeable	Widespread	1.25-3.5	20.0	30.0	2.7	-	-
4	Minor	Substantial	3.5-4.5	13.2	47.1	92.3	58.8	14.7
5	Substantial	Extensive	7.5-20	-	0.2	5.0	41.2	83.0
6	Major	Nearly total	20-65	-	-	-	-	2.3
7	Building condemned		100	-	-	-	-	-
8	Collapse		100	-	-	-	-	-

Damage Probability Matrices based on expert judgement and opinion were first introduced in ATC-13 (ATC, 1985). More than 50 senior earthquake engineering experts were asked to provide low, best and high estimates of the damage factor (the ratio of loss to replacement cost, expressed as a percentage) for Modified Mercalli Intensities (MMI) from VI to XII for 36 different building classes. The low and high damage factor estimates provided by the experts were defined as the 90% probability bounds of a lognormal distribution, whilst the best estimate was taken as the median damage factor (Figure 2). Weighted means of the experts' estimates, based on the experience and confidence levels of the experts for each building class, were included in the averaging process, as described in Appendix G of ATC-13 (ATC, 1985). A lognormal distribution was then used to calculate the probability of a central damage factor by finding the area below the curve within a given damage factor range. Thus, a DPM could be produced for each intensity level for each building class. Examples of the use of DPMs based on the ATC-13 approach for the assessment of risk and loss include the city of Basel (Fah et al., 2001), Bogotá (Cardona and Yamin, 1997) and New Madrid (Veneziano et al., 2002).

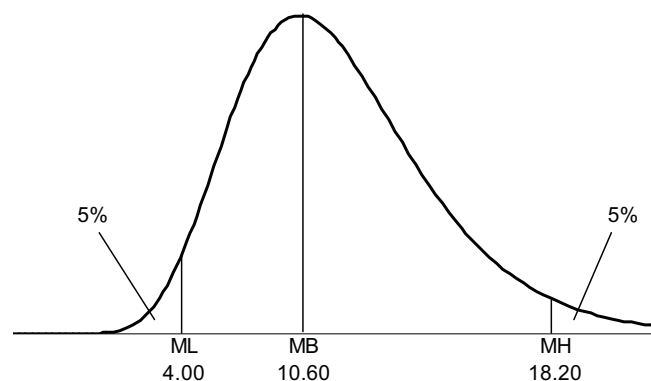

Fig. 2 Example of a lognormal distribution of the estimated damage factor for a given intensity showing the mean low (ML), mean best (MB), and mean high (MH) estimates of the damage factor (adapted from McCormack and Rad (1997))

A macroseismic method has recently been proposed (Giovinazzi and Lagomarsino, 2001, 2004) that leads to the definition of damage probability functions based on the EMS-98 macroseismic scale (Grünthal, 1998). The EMS-98 scale defines qualitative descriptions of “Few”, “Many” and “Most” for five damage grades for the levels of intensity ranging from V to XII for six different classes of decreasing vulnerability (from A to F). Damage matrices containing a qualitative description of the proportion of buildings that belong to each damage grade for various levels of intensity are presented in Table 2 for vulnerability class C.

Table 2: Example of a Damage Model for Vulnerability Class C as Presented in EMS-98

Damage Level Intensity	Damage Grade				
	1	2	3	4	5
V					
VI	Few				
VII		Few			
VIII		Many	Few		
IX			Many	Few	
X				Many	Few
XI					Many
XII					Most

The problems related to the “incompleteness” of the matrices (i.e., the lack of information for all damage grades for a given level of intensity) and the “vagueness” of the matrices (i.e., they are described qualitatively) have been tackled by Giovinazzi and Lagomarsino (2004) by assuming a beta damage distribution and by applying Fuzzy Set Theory, respectively. The damage probability matrices produced for each vulnerability class have been related to the building stock through the use of an empirical vulnerability index which depends on the building typology, the characteristics of the building stock (e.g., number of floors, irregularity, etc.) and the regional construction practices. This macroseismic method has already been applied in the risk assessment of the cities, Faro (Oliveira et al., 2004), Lisbon (Oliveira et al., 2005), and Barcelona (Lantada et al., 2004).

Following the introduction of DPMs based on intensity, the assessment of seismic risk on a large scale was made possible in both an efficient and cost-effective manner because in the past seismic hazard maps were also defined in terms of macroseismic intensity. The use of observed damage data to predict the future effects of earthquakes also has the advantage that when the damage probability matrices are applied to regions with similar characteristics, a realistic indication of the expected damage should result and many uncertainties are inherently accounted for. However, there are various disadvantages associated with the continued use of empirical methods such as DPM's:

- A macroseismic intensity scale is defined by considering the observed damage of the building stock and thus in a loss model both the ground motion input and the vulnerability are based on the observed damage due to earthquakes.
- The derivation of empirical vulnerability functions requires the collection of post-earthquake building damage statistics at sites with similar ground conditions for a wide range of ground motions: this will often mean that the statistics from multiple earthquake events need to be combined. In addition, large magnitude earthquakes occur relatively infrequently near densely populated areas and so the data available tends to be clustered around the low damage/ground motion end of the matrix thus limiting the statistical validity of the high damage/ground motion end of the matrix.
- The use of empirical vulnerability definitions in evaluating retrofit options or in accounting for construction changes (that take place after the earthquakes on which those are based) cannot be explicitly modelled; however simplifications are possible, such as upgrading the building stock to a lower vulnerability class.

- Seismic hazard maps are now defined in terms of PGA (or spectral ordinates) and thus PGA needs to be related to intensity; however, the uncertainty in this equation is frequently ignored. When the vulnerability is to be defined directly in terms of PGA, where recordings of the level of the ground shaking at the site of damage are not available, it might be necessary to predict the ground shaking at the site using a ground motion prediction equation; however, again the uncertainty in this equation needs to be accounted for in some way, especially the component related to spatial variability.
- When PGA is used in the derivation of empirically-defined vulnerability, the relationship between the frequency content of the ground motions and the period of vibration of the buildings is not taken into account.

2. Vulnerability Index Method

The “Vulnerability Index Method” (Benedetti and Petrini, 1984; GNDT, 1993) has been used extensively in Italy in the past few decades and is based on a large amount of damage survey data; this method is ‘indirect’ because a relationship between the seismic action and the response is established through a ‘vulnerability index’. The method uses a field survey form to collect information on the important parameters of the building which could influence its vulnerability: for example, plan and elevation configuration, type of foundation, structural and non-structural elements, state of conservation and type and quality of materials. There are eleven parameters in total, which are each identified as having one of four qualification coefficients, K_i , in accordance with the quality conditions – from A (optimal) to D (unfavourable) – and are weighted to account for their relative importance. The global vulnerability index of each building is then evaluated using the following formula:

$$I_v = \sum_{i=1}^{11} K_i W_i \quad (1)$$

The vulnerability index ranges from 0 to 382.5, but is generally normalised from 0 to 100, where 0 represents the least vulnerable buildings and 100 the most vulnerable. The data from past earthquakes is used to calibrate vulnerability functions to relate the vulnerability index (I_v) to a global damage factor (d) of buildings with the same typology, for the same macroseismic intensity or PGA. The damage factor ranges between 0 and 1 and defines the ratio of repair cost to replacement cost. The damage factor is assumed negligible for PGA values less than a given threshold and it increases linearly up until a collapse PGA, from where it takes a value of 1 (Figure 3).

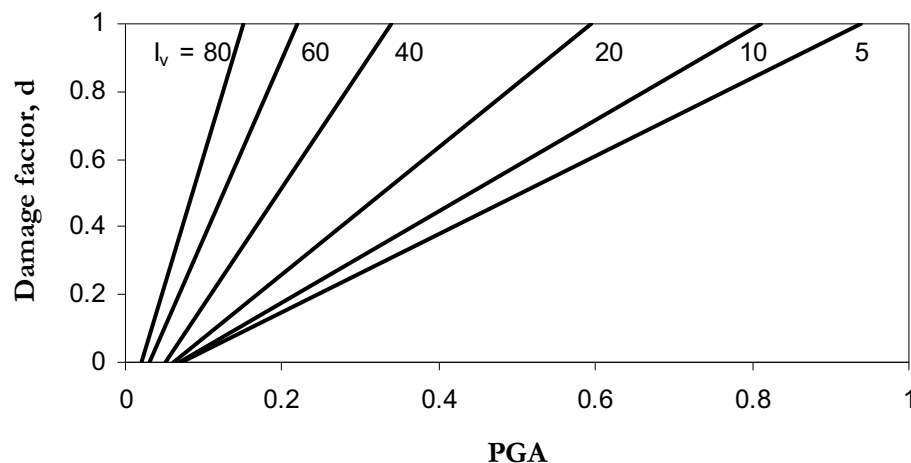

Fig. 3 Vulnerability functions to relate damage factor (d) and peak ground acceleration (PGA) for different values of vulnerability index (I_v) (adapted from Guagenti and Petrini (1989))

RISK_UE (An Advanced Approach to Earthquake Risk Scenarios with Application to Different European Towns) was a major research project financed by the European Commission (see www.risk-ue.net). Seven European cities (Barcelona, Bitola, Bucharest, Catania, Nice, Sofia and Thessaloniki) were

involved in this project, whose main objective was to develop a general methodology for the seismic risk assessment of European towns. The Vulnerability Index Method was adopted as one of the vulnerability assessment procedures which were developed and successfully applied to all of the aforementioned cities.

The “Catania Project”, discussed in Faccioli et al. (1999) and GNDT (2000), used an adapted vulnerability index method for the risk assessment of both masonry and reinforced concrete buildings. Some modifications to the original vulnerability index procedure were applied in that a rapid screening approach was used to define the vulnerability scores of the buildings, following the guidelines of ATC-21 (ATC, 1988). As in the original procedure, the vulnerability score was obtained from the weighted sum of eleven parameters; however, only some were directly obtained from a field assessment, while the rest were based on a range of values according to historic or recent construction practices within the region, thus leading to a lower and an upper bound to I_v for each building. Vulnerability functions for old masonry buildings were calibrated to the damage observed after the 1976 Friuli and the 1984 Abruzzo earthquakes, and damage and peak ground acceleration were correlated through the relationship proposed by Guagenti and Petrini (1989) (see Figure 3).

The main advantage of ‘indirect’ vulnerability index methods is that they allow the vulnerability characteristics of the building stock under consideration to be determined, rather than base the vulnerability definition on the typology alone. Nevertheless, the methodology still requires expert judgement to be applied in assessing the buildings, and the coefficients and weights applied in the calculation of the index have a degree of uncertainty that is not generally accounted for. Furthermore, in order for the vulnerability assessment of buildings on a large (e.g., national) scale to be carried out using vulnerability indices, a large number of buildings which are assumed to represent the national building stock need to be assessed and combined with the census data (e.g., Bernardini, 2000); in a country where such data is not already available, the calculation of the vulnerability index for a large building stock would be very time consuming. However, in any risk or loss assessment model a detailed collection of input data is required for application at the national scale.

3. Continuous Vulnerability Curves

Continuous vulnerability functions based directly on the damage of buildings from past earthquakes were introduced slightly later than DPMs; one obstacle to their derivation being the fact that macroseismic intensity is not a continuous variable. This problem was overcome by Spence et al. (1992) through the use of their Parameterless Scale of Intensity (PSI) to derive vulnerability functions based on the observed damage of buildings using the MSK damage scale (Figure 4). Orsini (1999) also used the PSI ground-motion parameter to derive vulnerability curves for apartment units in Italy. Both studies subsequently converted the PSI to PGA using empirical correlation functions, such that the input and the response were not defined using the same parameter.

Sabetta et al. (1998) used post-earthquake surveys of approximately 50000 buildings damaged by destructive Italian earthquakes in order to derive vulnerability curves. The database was sorted into three structural classes and six damage levels according to the MSK macroseismic scale. A mean damage index, calculated as the weighted average of the frequencies of each damage level, was derived for each municipality where damage occurred and each structural class. Empirical fragility curves with a binomial distribution were derived as a function of PGA, Arias Intensity and effective peak acceleration. Rota et al. (2006) have also used data obtained from post-earthquake damage surveys carried out in various municipalities over the past 30 years in Italy in order to derive typological fragility curves for typical building classes (e.g., seismically designed reinforced concrete buildings of 1-3 storeys). Observational damage probability matrices were first produced and then processed to obtain lognormal fragility curves relating the probability of reaching or exceeding a given damage state to the mean peak ground acceleration at the coordinate of the municipality where the damaged buildings were located. The PGA has been derived using the magnitude of the event and the distance to the site based on the attenuation relation by Sabetta and Pugliese (1987), assuming rock site conditions.

Alternative empirical vulnerability functions have also been proposed, generally with normal or lognormal distributions, which do not use macroseismic intensity or PGA to characterise the ground motion but are related to the spectral acceleration or spectral displacement at the fundamental elastic period of vibration (e.g., Rossetto and Elnashai, 2003; Scawthorn et al., 1981; Shinozuka et al., 1997). The latter has been an important development as it has meant that the relationship between the frequency content of the ground motion and the fundamental period of vibration of the building stock is taken into

consideration; in general this has been found to produce vulnerability curves which show improved correlation between the ground motion input and damage (see Figure 5).

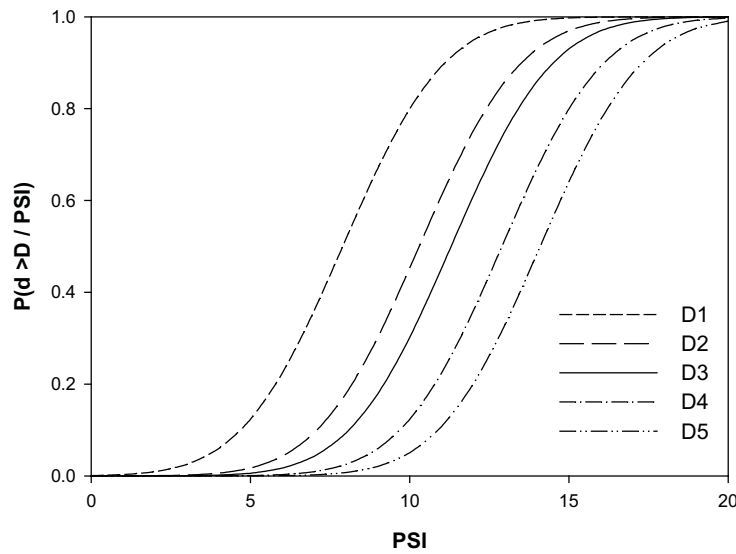

Fig. 4 Vulnerability curves produced by Spence et al. (1992) for bare moment-resisting frames using the parameterless scale of intensity (PSI); D1 to D5 relate to damage states in the MSK scale

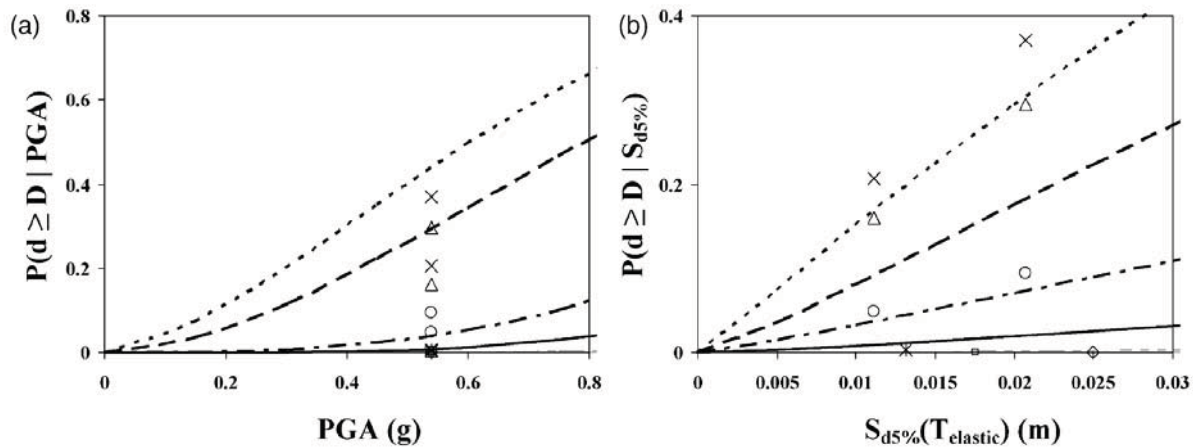

Fig. 5 Example of the difference in the vulnerability point distribution using the observations of low and mid-rise building damages after the 1995 Aegion (Greece) earthquake for different ground motion parameters: (a) PGA, and (b) Spectral displacement at the elastic fundamental period (Rossetto and Elnashai, 2003)

The introduction of vulnerability curves based on spectral ordinates, rather than PGA or macroseismic intensities, has also certainly been facilitated by the emergence of more and more attenuation equations in terms of spectral ordinates.

4. Screening Methods

In Japan, the evaluation of the seismic performance of existing reinforced concrete buildings with less than 6 storeys has been carried out since 1975 with the use of the Japanese Seismic Index Method (JBDPA, 1990). Three seismic screening procedures are available to estimate the seismic performance of a building with the reliability increasing with each screening level. The seismic performance of the building is represented by a seismic performance index, I_S , which should be calculated for each storey in every frame direction within the building using the following equation:

$$I_S = E_o S_D T \quad (2)$$

where E_o is for the basic structural performance, S_D is the sub-index concerning the structural design of the building, and T is the sub-index for the time-dependent deterioration of the building. The method to calculate E_o involves the calculation and multiplication of an ultimate strength index C and a ductility index F , considering the failure mode, the total number of storeys and the position of the storey under examination. The influence of irregularity, stiffness and/or mass concentration of a structure on the seismic performance should be accounted for by the sub-index S_D . The influence of deterioration and cracking is taken into account by the sub-index T , which is based on the data found through a field investigation. Once the seismic performance index I_S has been calculated it should be compared with the seismic judgement index for the structure I_{S0} to determine whether the building can be called “safe” against an assumed earthquake ground motion (i.e., if $I_S > I_{S0}$). There are three possibilities depending on the difference between I_S and I_{S0} :

- $I_S \geq I_{S0}$; corresponds to a low vulnerability condition for all three screening levels,
- $I_S \ll I_{S0}$; corresponds to a high level of vulnerability that requires retrofitting or demolition of the structure, or
- $I_S < I_{S0}$; is an uncertain condition when I_S is only slightly smaller than I_{S0} (I_S falls within an interval between I_{S0} and a lower limit that is based on the observed damage of reinforced concrete buildings) and thus requires a more detailed assessment using the next screening level or nonlinear dynamic analysis.

The seismic judgement index, I_{S0} , should be calculated as

$$I_{S0} = E_S Z G U \quad (3)$$

where E_S was originally taken as 0.6 for the second and third level screening and 0.8 for the first (hence providing an increase in the demand due to a lack of reliability of the method); Z is a zone index used to modify the intensity of the ground motion assumed at the site of the building; G is the ground index used to account for ground-building interaction, amplification in the top layer of ground, or topographical effects; and U is a usage index which may be seen as a kind of importance factor concerned with the function of the building. This seismic judgement index suggests a storey shear force which is independent of the ground motion, but the force obviously depends on the response of the building and so in the 1998 revised version of the Japanese Building Standard Law the index I_{S0} is taken as the spectral acceleration (in terms of g) at the period of response of the structure in question. This index should be distributed up the height of the structure, and a triangular distribution is suggested.

The rapid assessment of the seismic performance of existing reinforced concrete buildings has received particular attention in Turkey in recent years. Several preliminary assessment methods have been proposed that require the dimensions of the lateral load resisting elements to be defined. Hassan and Sozen (1997) have proposed a procedure to define a “Priority Index” for each building, which is a function of a wall index (area of walls and infill panels divided by total floor area) and a column index (area of columns divided by total floor area). Damage data can be used to calibrate the “Priority Index” and define the level of vulnerability of the building. Yakut (2004) has recently proposed a “Capacity Index”, which considers the orientation, size and material properties of the lateral load-resisting structural system as well as the quality of workmanship and materials and architectural features such as short columns and plan irregularities. Buildings are classified as either at low risk (and thus should not suffer severe damage) or at high risk (and thus would probably not meet the life-safety performance level of recent seismic codes). These rapid vulnerability assessment methods are of particular use for prioritising buildings for further, more detailed assessments that would be required to design a rehabilitation scheme.

The Seismic Safety Screening Method (SSSM) has recently been proposed by Ozdemir et al. (2005), which is an adaptation of the Japanese Seismic Index Method (JBDPA, 1990). This rapid seismic safety evaluation method can be applied to structures with 6 storeys or less and with reinforced concrete frame,

shear wall or dual frame-shear wall structural systems. As with the Japanese method, the principle of the method is that the seismic capacity of a building is represented by a seismic index value, I_S , which is a function of its strength and ductility. If the building has a seismic index value that is lower than a seismic demand index value (I_D , dependent on the seismicity of the region of interest) then detailed structural analysis would be necessary for further assessment of the vulnerability; otherwise the building can be judged as 'safe'. This method has been calibrated to Turkish buildings using nonlinear static analyses of 12 buildings from Zeytinburnu, Istanbul (Ozdemir et al., 2005).

The use of rapid screening methods has an important role to play in the definition of prioritisation of buildings for seismic retrofit, but the use of such methods in large-scale seismic risk models is limited due to the need to consider buildings individually in a deterministic fashion, and thus this would not be economically feasible.

ANALYTICAL/MECHANICAL METHODS

The emergence of more attenuation equations in terms of spectral ordinates and the corresponding derivation of seismic hazard maps in terms of spectral ordinates, as opposed to macroseismic intensity or PGA, has not only catered to the aforementioned improvement of empirical methods, but also given rise to the development of analytical methods. These methods tend to feature slightly more detailed and transparent vulnerability assessment algorithms with direct physical meaning, that not only allow detailed sensitivity studies to be undertaken, but also cater to straightforward calibration to various characteristics of building stock and hazard. The latter is a definite disadvantage of empirical methods. Such characteristics place the analytical type of loss assessment approaches, as described below, in an ideal position for employment in parametric studies that aim at the definition/calibration of urban planning, retrofitting, insurance and other similar policies or initiatives.

1. Analytically-Derived Vulnerability Curves and DPMs

Although vulnerability curves and damage probability matrices have traditionally been derived using observed damage data, recent proposals have made use of computational analyses to overcome some of the drawbacks of the methods highlighted in the previous section. Figure 6 summarises the basic components that are required to analytically derive vulnerability curves or damage probability matrices.

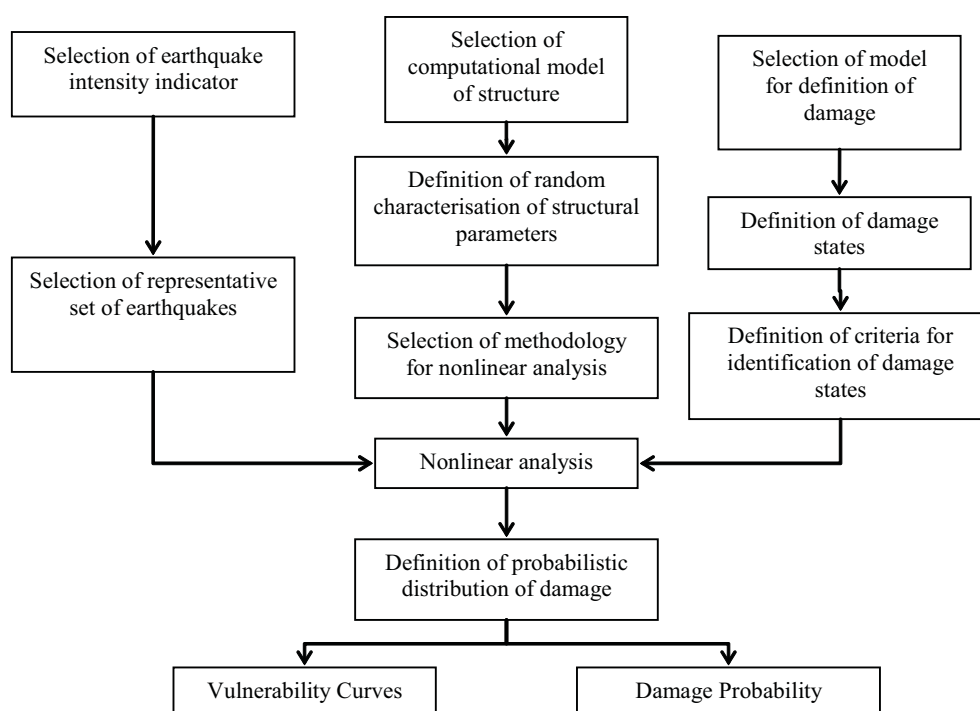
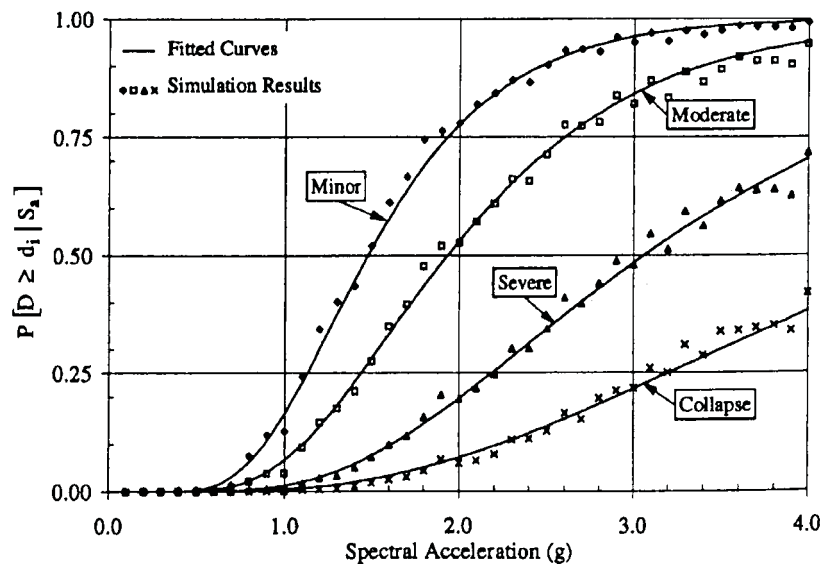

Fig. 6 Flowchart to describe the components of the calculation of analytical vulnerability curves and damage probability matrices (adapted from Dumova-Jovanoska (2004))

Singhal and Kiremidjian (1996) developed fragility (or vulnerability) curves and damage probability matrices for three categories of reinforced concrete frame structures using Monte Carlo simulation. The probabilities of structural damage were determined using nonlinear dynamic analysis with an ensemble of ground motions. For the DPMs, Modified Mercalli Intensity was used as the ground-motion parameter, whilst spectral acceleration was used for the generation of fragility functions. The major components of the methodology consist of: 1) characterisation of the structure when subjected to dynamic loads; 2) characterisation of the potential ground motions; and 3) quantification of the structural response accounting for the variability in the ground motion and the uncertainty in the structural response. Nonlinear dynamic analyses were carried out using an ensemble of time-histories, corresponding to a given level of ground motion, for many buildings with random structural characteristics. The output of each nonlinear analysis was used to calculate a global damage index (related to a particular damage state), based on the model by Park and Ang (1985), because it is simple and has been calibrated using data from various structures damaged during past earthquakes. Statistical analysis of the damage indices led to the evaluation of the probabilities of different damage states and thus fragility functions and DPMs were evaluated (Figure 7). The analytical vulnerability curves produced by Singhal and Kiremidjian (1996) for low-rise frames described were subsequently updated based on the observational data obtained from a tagging survey of 84 buildings damaged by the 1994 Northridge earthquake, while using a weighting system (Bayesian updating technique) to take into account the reliability of different data sources (Singhal and Kiremidjian, 1998).



(a)

Damage state (1)	Modified Mercalli Intensity						
	VI (2)	VII (3)	VIII (4)	IX (5)	X (6)	XI (7)	XII (8)
None	99.5	97.0	85.4	52.9	14.1	0.9	—
Minor	0.3	1.6	6.9	16.9	15.5	3.4	0.1
Moderate	0.2	1.1	5.4	18.5	30.5	17.6	2.8
Severe	—	0.2	1.4	7.0	20.7	28.0	14.6
Collapse	—	0.1	0.9	4.7	19.2	50.1	82.5

(b)

Fig. 7 (a) Fragility curves; (b) Damage probability matrix for sample low-rise buildings (Singhal and Kiremidjian, 1996)

Masi (2003) employed a similar procedure to characterise the seismic vulnerability of different types of reinforced concrete frames (bare, regularly infilled, and pilotis) designed for vertical loads alone. The structural models employed in this study were representative of the buildings designed and constructed in Italy over the past 30 years. A simulated design of the structures was carried out with reference to design

codes, available handbooks and known practice at the time of construction. The seismic response of the designed prototype structures, subjected to ground motions of various levels of intensity, was estimated through nonlinear dynamic analyses with artificial and natural accelerograms, whilst the vulnerability was characterised through the use of the European Macroseismic Scale (EMS98) as discussed above.

Rossetto and Elnashai (2005) constructed adaptive pushover curves of European buildings and applied the capacity spectrum methodology (see Sub-section 4 below) to obtain the performance point which was then correlated to a damage state through a damage scale calibrated to experimental data (Rossetto and Elnashai, 2003). This procedure was repeated using the acceleration-displacement spectra of many ground-motion records and the variability in the structural characteristics of the buildings was modelled using a response surface method, thus leading to the derivation of analytical displacement-based vulnerability curves.

Dumova-Jovanoska (2004) produced vulnerability curves/damage probability matrices for reinforced concrete buildings built in the Skopje region. These earthquake damage-intensity relationships were derived by analytically modelling the representative RC buildings and by running the dynamic nonlinear analysis with a set of 240 synthetic earthquake records. The damage to the structures was measured using the damage index by Park and Ang (1985) and corresponding individual discrete damage states. A normal probabilistic distribution was assumed for the probability of occurrence of damage.

One of the principle disadvantages of the derivation of analytical vulnerability curves is that the procedure is extremely computationally intensive and time consuming and thus the curves cannot be easily developed for different areas or countries with diverse construction characteristics. However, analytical vulnerability curves have frequently been used to support, rather than to replace, the empirical DPMs and vulnerability curves based on the observational damage data, leading to what are known as hybrid methods, as discussed in more detail in the next sub-section.

2. Hybrid Methods

Hybrid damage probability matrices and vulnerability functions combine post-earthquake damage statistics with simulated, analytical damage statistics from a mathematical model of the building typology under consideration, as has been described in the previous sub-section. Hybrid models can be particularly advantageous when there is a lack of damage data at certain intensity levels for the geographical area under consideration and they also allow calibration of the analytical model to be carried out. Furthermore, the use of observational data reduces the computational effort that would be required to produce a complete set of analytical vulnerability curves of DPMs.

Kappos et al. (1995, 1998) have derived damage probability matrices using a hybrid procedure, in which parts of the DPMs for each intensity level were constructed using the available data from past earthquakes following the “Vulnerability Index Procedure” as discussed above. The remaining parts of the DPMs were constructed using the results of nonlinear dynamic analysis of models that simulated the behaviour of each building class. The time-history records were scaled to PGA values estimated by the seismic hazard analysis; intensity and PGA were correlated using empirical relationships. A global damage index was derived to correlate the structural response from the dynamic analysis (ductility factors, displacements, etc.) with loss, expressed in terms of the cost of repair. A total of 120 analyses of typical Greek buildings designed for the 1959 code were run (for 6 structures, 10 ground motions and 2 intensities), and the statistical damage results were combined with the observed damage from the 1978 earthquake in Thessaloniki.

Barbat et al. (1996) used the Italian “Vulnerability Index Methodology” for a hybrid vulnerability assessment of Spanish urban areas. A post-earthquake study was initially performed for two earthquakes with a maximum intensity of VII on the MSK scale. The structural and non-structural damage to masonry structures was analysed and correlated to the vulnerability and damage indices used in the Italian methodology. Statistical analyses were then performed to obtain the vulnerability function for the MSK intensity level VII. A computer simulation process was subsequently used to obtain the vulnerability functions at other intensity levels. Sixty hypothetical buildings with characteristics obtained from the building stock in the area were generated using Monte Carlo simulation (considering a uniform probability density function for the capacity parameters) in order to simulate the behaviour of a complete urban zone, and a simplified analytical procedure proposed by Abrams (1992) was chosen to model the capacity/demand relationship of masonry structures. The vulnerability index was calculated for each building, this was plotted against the global damage index (based on the capacity/demand ratios of the

structural members) for the MSK intensity level VII, and a curve was obtained by regression analysis; this curve was then re-calibrated so as to match the field observations (Figure 8). The difference between the curves in Figure 8 was assumed to be due to the use of the proposed weighting factors for Italian buildings and so the weighting factors were modified such that the observed and calculated vulnerability functions matched. Once the calibration with the 60 random buildings had been carried out, the vulnerability functions for the other intensity levels were then produced using 2000 hypothetical buildings in conjunction with the calibrated weighting factors.

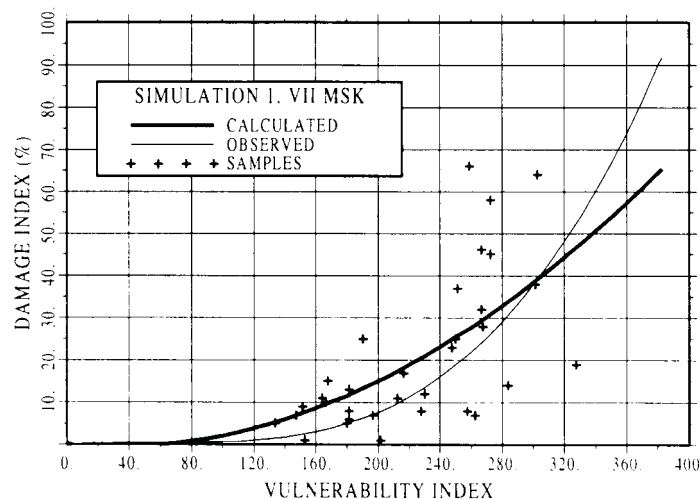

Fig. 8 Simulated (thick line) and observed (thin line) vulnerability functions for MSK intensity VII (Barbat et al., 1996)

The main difficulty in the use of hybrid methods is probably related to the calibration of the analytical results, considering that the two vulnerability curves include different sources of uncertainty and are thus not directly comparable. In the analytical curves the sources of uncertainty are clearly defined during the generation of the curves whilst the specific sources and levels of variability in the empirical data are not quantifiable. The method used to calibrate the analytical vulnerability curves using empirical data should depend on whether the aim is to include the additional uncertainty present in the empirical data which is not accounted for in the analytical data or whether the aim is in fact to improve the analytical model used to define the capacity of the building stock. If the principle goal is the latter, then perhaps it would be preferable to calibrate the vulnerability curves considering the median (50 percentile) values, and an adaptation of the analytical model could be made such that the two median values coincide. In this way, the observational data is used to calibrate the analytical model, but analytically-derived vulnerability curves with their known and specified sources of uncertainty are used in the loss model. This can be of use when only the uncertainty related to the capacity of the building stock is required and not that related to the ground motion; for example, such curves are needed when a probabilistic seismic hazard assessment is used to define the ground motion, as this will ensure that the latter variability is not double-counted (e.g., Bommer and Crowley, 2006).

3. Collapse Mechanism-Based Methods

Many recent proposals for analytical vulnerability assessment methods use collapse multipliers calculated from mechanical concepts to ascertain whether a mechanism will form and thus damage will occur; these procedures have been particularly applied to masonry buildings.

VULNUS is a method that has been proposed for the vulnerability assessment of unreinforced masonry buildings (URMB) using the fuzzy-set theory and the definition of collapse multipliers (Bernardini et al., 1990). A collapse multiplier for in-plane behaviour (I_1) with shear failure at the ground floor is defined as the ratio of the in-plane shear strength of the system of walls to the total weight:

$$I_1 = \frac{\min(V_x, V_y)}{W} \quad (4)$$

where W is the total weight of the building, and V_x and V_y represent the strength at mid-storey height of the ground floor in the x - and y -directions. The latter can be calculated considering the tensile strength of the masonry and the total area of the walls. The collapse multiplier for the out-of-plane behaviour (I_2) is found from the ratio of the out-of-plane flexural strength of the most critical external wall to the total weight, evaluated by summing the resistance of the vertical (I_2') and horizontal strips (I_2''):

$$I_2 = \min_i (I_2' + I_2'') \tag{5}$$

Following the calculation of the two collapse multipliers, a third index I_3 is calculated, which is the weighted sum of the scores of seven partial vulnerability factors:

$$I_{3i} = \sum_i \frac{W_i S_i}{45 \times 3.15} \tag{6}$$

where the score S_i ranges from 0 (good) to 45 (poor), and the weight, W_i , is assigned depending on the relative importance of the factors on the vulnerability of the building. The mean absolute acceleration response A of the building (i.e., maximum base shear divided by total weight) is calculated as well as an uncertainty factor a , which is obtained from the fuzzy-set theory using I_3 . The probability of exceeding the D4 limit state (based on the EMS98 damage scale) for a group of buildings is a function of the aforementioned parameters: $V_g = f(I_1, I_2, A, a)$.

Failure Mechanism Identification and Vulnerability Evaluation (FaMIVE) method (D'Ayala and Speranza, 2002) is another procedure based on collapse multipliers, which is aimed towards the vulnerability assessment of historic buildings and town centres. The most probable collapse mechanism is found for both in-plane and out-of-plane failures by calculating the load factor or collapse multiplier through an equivalent static procedure. A number of possible out-of-plane collapse mechanisms are assumed (see Figure 9); the equivalent shear capacity is calculated for each façade wall of the building under consideration for each collapse mechanism, and the most likely mechanism is identified as that with the lowest capacity.

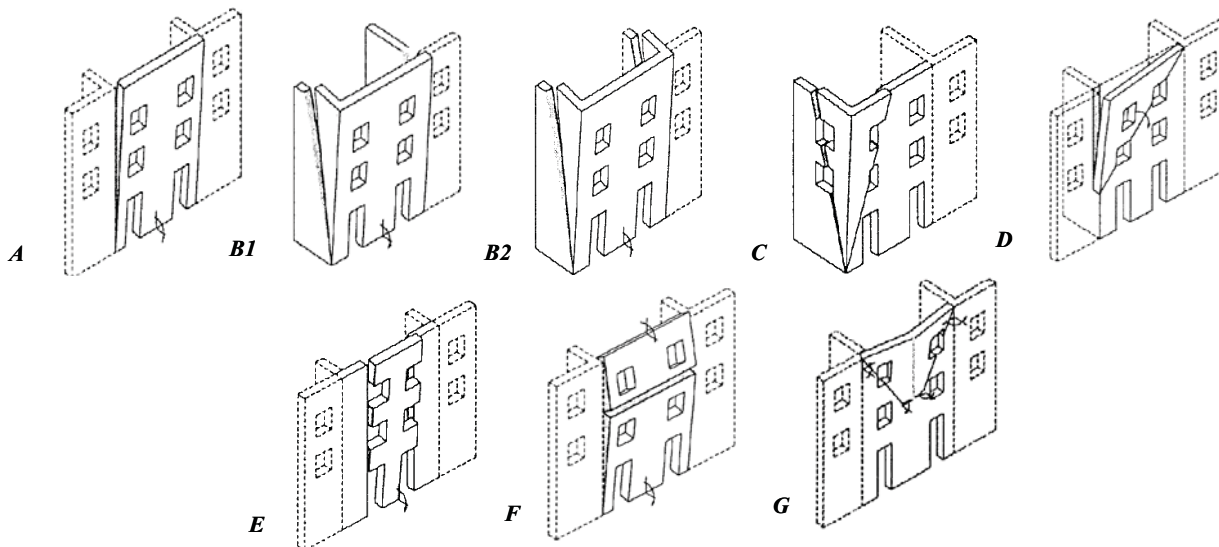

Fig. 9 Out-of-plane failure mechanisms (after D'Ayala and Speranza, 2002)

Cosenza et al. (2005) presented a mechanics-based approach for the assessment of reinforced concrete buildings, which is also based on the formation of collapse mechanisms. First, the seismic capacity of a generic building model is defined. The assumed pre-defined mechanisms are established (see Figure 10) and the corresponding base shear, V_{bi} , is calculated assuming a linear distribution of horizontal seismic forces.

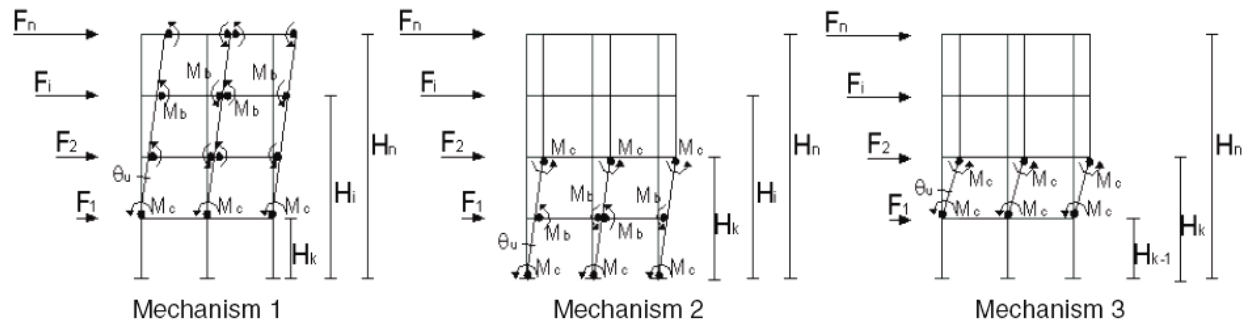

Fig. 10 Analysed collapse mechanisms (Cosenza et al., 2005)

The ultimate roof displacement Δ_{ui} is determined as a function of the ultimate rotation θ_u of the structural elements:

$$\Delta_{u,1} = \theta_u (H_n - H_k) \tag{7}$$

$$\Delta_{u,2} = \theta_u H_k \tag{8}$$

$$\Delta_{u,3} = \theta_u (H_k - H_{k-1}) \tag{9}$$

The global seismic behaviour is then represented by the base shear coefficient $C_{b,i}$ (i.e., base shear $V_{b,i}$ divided by seismic weight W) and the corresponding lateral (drift $_u$) $_i$ (i.e., roof displacement divided by building height):

$$C_{b,i} = \frac{V_{b,i}}{W}; \quad (\text{drift}_u)_i = \frac{\Delta_{u,i}}{H_n} \tag{10}$$

Seismic response is evaluated for $3n_z$ mechanisms, where n_z represents the number of storeys; the seismic capacity corresponds to the lowest $C_{b,i}$ of all the considered mechanisms and the associated drift. The seismic capacity of building stock will vary from the generic building due to different morphologic/geometric/structural configurations and material properties. Hence, a number of building models are generated based on the probabilistic distribution of the structural parameters. A Monte Carlo simulation technique is applied to calculate “probabilistic capacity curves” which express the probability of having a capacity lower than the assigned value: this can be likened to the percentage of buildings with a value of capacity lower than a given threshold value.

A clear framework for the treatment of uncertainty in the geometric and material properties in an urban environment is accounted for in the method by Cosenza et al. (2005), whilst this is not the case for the VULNUS and FaMIVE procedures. However, the main disadvantage of the procedure by Cosenza et al. (2005), and also FaMIVE, is that no clear indication is given on how the capacity is to be convolved with the demand to calculate the probability of exceeding given limit states. The VULNUS procedure does allow the estimation of the probability of damage, but only for one limit state, i.e., the collapse limit state. Thus, the use of these collapse-mechanism methods within a loss assessment model appears to be somewhat limited at present.

4. Capacity Spectrum-Based Methods

HAZUS (Hazard US) is the outcome of a project conducted for the National Institute of Building Science (NIBS), under a cooperative agreement with the Federal Emergency Management Agency (FEMA), to develop a nationally applicable methodology for estimating the potential losses from earthquakes on a regional basis (Whitman et al., 1997; FEMA, 1999, 2003). The main modules of the methodology are as follows:

- The estimation of the Potential Earth Science Hazards (PESH); these include ground motion, ground failure (liquefaction, landslides and surface fault rupture) and tsunami/seiche.

- The inventory is divided into buildings, facilities, transportation systems, utility systems, and hazardous material facilities. The inventory is then further partitioned into pre-defined building classes with similar damage/loss characteristics.
- Direct physical damage is calculated for each building class to find the probability of none, slight, moderate, extensive and complete structural and non-structural damage due to each type of PESH.
- Induced physical damage from inundation, fire, hazardous materials and debris is estimated.
- Direct economic/social losses due to casualties, persons rendered homeless, and economic losses, which can be directly correlated to the damage, are estimated.
- Indirect economic losses due to downtime, that causes a chain reaction through the regional economy, are estimated.

The vulnerability assessment component of the procedure is contained within the direct physical damage module and is based on the Capacity Spectrum Method of ATC-40 (ATC, 1996). In this method, the performance point of a building type under a particular ground-shaking scenario (or PESH) is found from the intersection of an acceleration-displacement spectrum, representing the ground motion, and a capacity spectrum (pushover curve), representing the horizontal displacement of the structure under increasing lateral load (Kircher et al., 1997), as shown in Figure 11. The demand spectrum is reduced for both damping and duration effects. The reduction of the spectrum is applied to account for the hysteretic damping that occurs during inelastic behaviour of the structure, where the damping is based on the area enclosed by the hysteretic loop at peak response displacement and acceleration. A reduction factor is applied to the hysteretic damping as a function of shaking duration to simulate degradation (e.g., pinching) of the hysteresis loop during cyclic response.

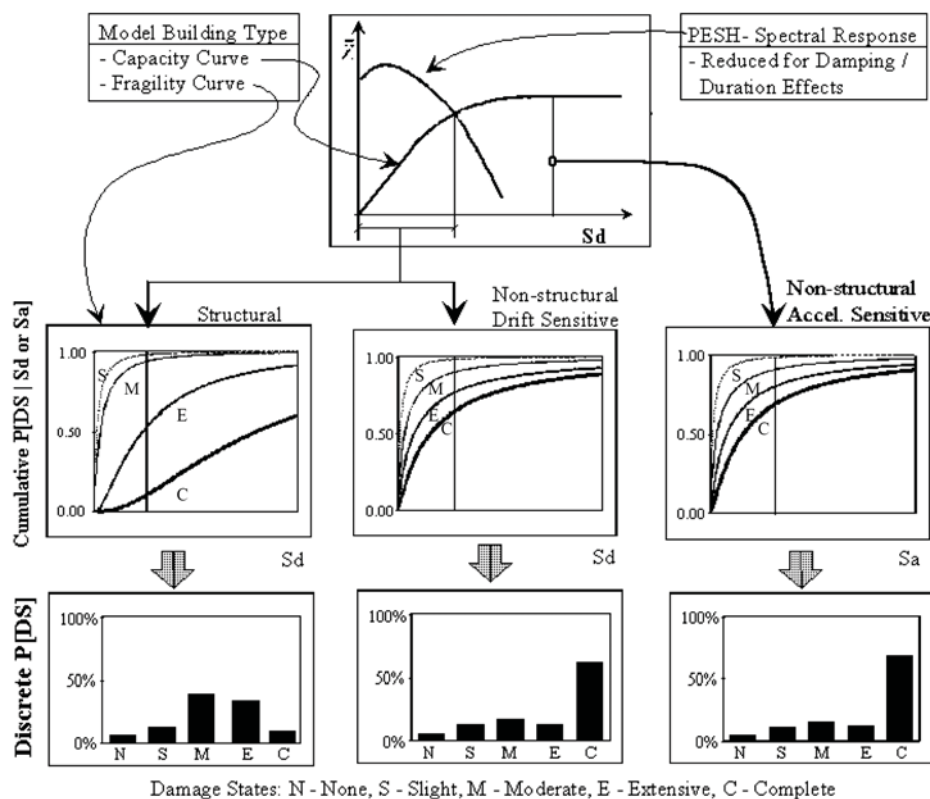

Fig. 11 Illustration of the estimation of damage from ground shaking in HAZUS (FEMA, 1999, 2003)

The capacity spectrum has been developed for each building class using model buildings designed for different levels of design practice in the US. The performance point obtained from this average building provides the displacement input into the limit state vulnerability curves to give the probability of being in a given damage band. The vulnerability curves are lognormal curves with a total logarithmic standard

deviation, β_{Sds} , which combines the uncertainty in the damage state threshold, $\beta_{M(Sds)}$, the variability in the capacity (response) properties of the model building type, β_C , and the uncertainty in the response due to the spatial variability of the ground-motion demand, β_D . The latter two components of the variability are inter-dependent (as the damped demand spectrum is dependent on the building capacity due to the nonlinearity of the capacity response and thus energy dissipation) and thus need to be combined using a complex process of convolution (CONV) of the probability distributions, before being combined with $\beta_{M(Sds)}$ using the square-root-of-the-sum-of-the-squares (SRSS):

$$\beta_{Sds} = \sqrt{\left(\text{CONV}\left[\beta_C \beta_D \bar{S}_{d,Sds}\right]\right)^2 + \left(\beta_{M(Sds)}\right)^2} \quad (11)$$

where $\bar{S}_{d,Sds}$ is the median spectral displacement for the damage state ds . Median spectral displacement (or acceleration) values and the total variability are developed for each of the model building types and damage states of interest through a combination of performance data (from tests of building elements), earthquake field data, expert opinion and judgement.

Once the proportion of buildings in each damage band (none, slight, moderate, extensive, and complete) has been obtained, a composite measure of damage, which aims to provide an idea of the expected overall rebuilding cost, is calculated by summing the proportions which are weighted by 0% for no damage, 2% for slight damage, 10% for moderate damage, 50% for extensive damage, and 100% for complete damage.

The HAZUS methodology was originally derived as a tool for estimating the impact of individual earthquake scenarios; it has been subsequently adapted (FEMA, 2001) to a full loss assessment methodology wherein the hazard from all possible earthquakes, derived from probabilistic seismic hazard assessment (PSHA), is considered. In this case, the variability in the demand is already modelled in the PSHA and so needs to be removed from the vulnerability curves to avoid double counting; the curves thus become lognormal functions with a logarithmic standard deviation given by

$$\beta_{Sds} = \sqrt{\left(\beta_C\right)^2 + \left(\beta_{M(Sds)}\right)^2} \quad (12)$$

The use of PSHA in regional loss models, although computationally efficient, is theoretically less robust than the representation of the seismic hazard by triggering a large number of earthquake scenarios that are compatible in magnitude, location and associated frequency of occurrence with the regional seismicity (e.g., Crowley and Bommer, 2006; Bazzurro and Luco, 2005).

A potential weakness of the method is that the capacity curves and vulnerability functions published in the HAZUS manual have been derived for buildings in the US having a limited range of storey heights; thus the application of this method to other parts of the world requires additional research to be carried out. Hence, capacity curves and vulnerability functions would need to be derived for the building stock under consideration; however, there is difficulty involved in obtaining a physically realistic representation of the inelastic response of the structure using pushover analysis. Although this aspect can be somewhat improved using the displacement-based adaptive pushover techniques (Antoniou and Pinho, 2004), a faithful representation of the real structural behaviour requires a great deal of information about the structure, including reinforcement details, which are unlikely to be well known for a large building stock.

HAZUS has been adopted all over the world for the loss assessment of urban areas. The methodology in itself has not been adapted in any way, but the capacity curves and fragility functions have been calibrated to the building stock under consideration. Examples include the loss assessment of Turkey carried out by Bommer et al. (2002), the seismic risk assessment of Oslo documented by Molina and Lindholm (2005), the loss estimation of Taiwan (using a modified version of HAZUS called Haz-Taiwan) as discussed in Yeh et al. (2000), and the RISK_UE project for the risk assessment of 7 European towns as discussed previously.

The LNECloss tool is an automatic seismic scenario loss estimation methodology that makes use of the capacity spectrum method and has been implemented in a GIS environment (Sousa et al., 2004). However, an equivalent approach to the capacity spectrum method to evaluate the performance point has been implemented in the LNECloss code. This alternative equivalent scheme to compute the performance point starts with the definition of an input motion in terms of a power spectral density function (PSDF) and an equivalent stationary duration, T . The seismic input needs to be defined in terms of response

spectra, associated to some damping coefficient, and thus a linear stochastic approach has been implemented in LNECloss to accomplish this transformation. This methodology illustrated in Figure 12 is being developed and implemented within the LESSLOSS Integrated Project (Calvi and Pinho, 2004) under the earthquake disaster scenario predictions and loss modelling for urban areas sub-project and is being applied to the city of Lisbon (see <http://www.lessloss.org/main/>).

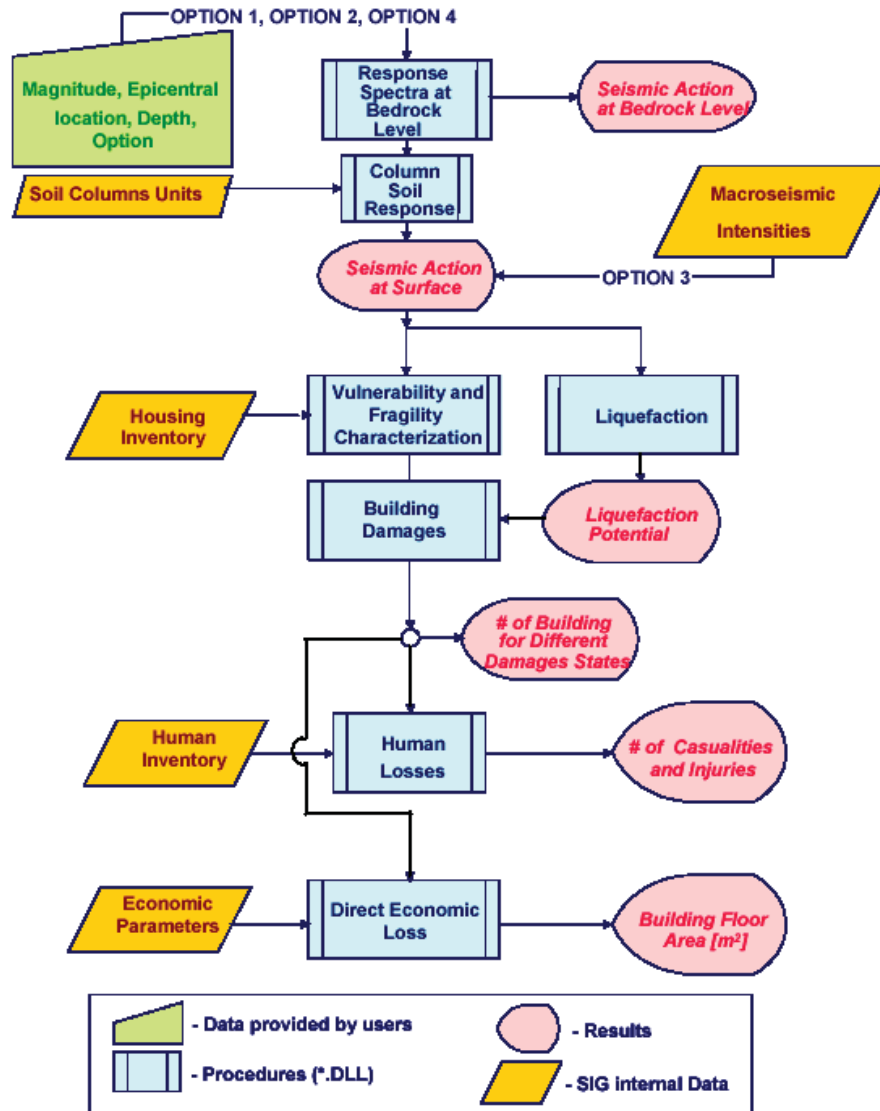

Fig. 12 Modules involved in the LNECloss tool (Sousa et al., 2004)

Giovinazzi (2005) presented a mechanical procedure for the risk assessment of both masonry and reinforced concrete frames. This uses simplified bilinear capacity spectra (capacity or ‘pushover’ curves converted to plots of spectral acceleration versus spectral displacement), which are derived using the equations and parameters available in seismic design codes. The base shear coefficient, which can be related to the yield spectral acceleration, is generally a function of seismic zone, soil conditions, building dynamic response, structural type, and building importance, all of which can be obtained from the codes. The yield spectral displacement is a function of the yield spectral acceleration and the yield period of vibration; the latter being calculated using the simple formulae available in seismic design codes which usually give the period as a function of the building height. The ultimate spectral displacement is a function of the yield displacement and the building ductility capacity, which has been assumed to be 2.5 for the reinforced concrete buildings that have not been seismically designed, or which can be derived as a function of the behaviour factor specified in the codes. The use of seismic design codes to calculate simplified pushover curves of the building stock is a cost-effective method for calibrating the vulnerability of buildings designed for different design codes. However, code-based definitions of the

yield period of vibration and base shear capacity of RC structures could differ greatly from the actual properties of the building stock (e.g., Crowley, 2003) and in many countries the existing building stock has been constructed without even conforming to any design code.

In the approach of Giovinazzi (2005), once capacity spectra for the building classes have been derived, the next step is to use the Capacity Spectrum Method, which has been developed and employed in HAZUS (FEMA, 1999, 2003). As has been described in the review of HAZUS, the performance point of the building class is obtained by comparing the capacity spectrum with the inelastic Acceleration-Displacement Response Spectrum (ADRS), which is produced by using codified spectral shapes anchored to the PGA obtained from the hazard analysis. Once the performance point is obtained it is inserted into the vulnerability curves in order to obtain the probability of exceeding pre-defined damage states. The method proposed by Giovinazzi for this stage of the risk assessment differs from that proposed in HAZUS, as discussed in what follows.

The mean values for the displacement thresholds ($S_{d,i}$) employed by Giovinazzi (2005) are functions of yield and ultimate displacement:

$$S_{d,1} = 0.7d_y \quad (13)$$

$$S_{d,2} = 1.5d_y \quad (14)$$

$$S_{d,3} = 0.5(d_y + d_u) \quad (15)$$

$$S_{d,4} = d_u \quad (16)$$

These thresholds have been based on expert judgement and have been verified on the basis of the results of pushover analyses performed on prototype buildings, though details of these analyses have not been reported. In order to model the variability in the estimation of the damage suffered by a building (which is due to the uncertainty in the capacity curve, the damage state definition and the seismic demand spectra), rather than combining the logarithmic standard deviations assigned to each of these uncertainties (as carried out in HAZUS), the proposed procedure is “to evaluate the overall uncertainty in the damage estimation in such a way that it can represent the same dispersion of observed damage data that...are well fitted by a binomial distribution”. Giovinazzi (2005) argued that the binomial distribution had been shown to fit damage data by Braga et al. (1982) and Spence et al. (2003); however, Giovinazzi admitted that there were problems with the use of this distribution as it does not allow a variation of the scatter around the mean damage band (i.e., it is fixed) and Spence et al. (2003) have shown that frame structures may follow a very different, more complex distribution (see Figure 13 where observed damage data from the Kocaeli earthquake of 1999 is presented and compared with the results from various risk assessment procedures for reinforced concrete frames).

Indeed, the authors believe that forcing the damage distribution to follow a binomial distribution could lead to erroneous damage predictions in many cases where non-ductile reinforced concrete frames are considered in a loss model. The observed damage distribution, as presented in Figure 13, can be easily understood by considering the behaviour of such frames: once the first/yield limit state has been exceeded, the inadequate confinement in these buildings will ensure that they will very rapidly fail the higher limit states also due to the low levels of attainable limit state strains (and consequently low levels of ductility). For this reason, the vulnerability curves for the different damage states for these frames should be steep and close together. It is therefore expected that the damage distribution will show larger proportions at the extreme damage bands (i.e., slight and complete damage) with lower proportions being predicted for the intermediate damage states for moderate ground-motion inputs. For well-designed buildings, however, there should be a greater separation between the curves, representing the greater post-yield capacity due to the higher limit state strains of adequately confined members, and thus a binomial/normal/lognormal type of damage distribution could be expected.

5. Fully Displacement-Based Methods

The first steps towards the development of a fully displacement-based vulnerability assessment framework can be found in Calvi (1999). This paper proposed a holistic methodology that used displacements as the fundamental indicator of damage and a spectral representation of the earthquake demand. This procedure utilised the principles of the Direct Displacement-Based Design method (e.g., Priestley, 2003), wherein a multi-degree-of-freedom (MDOF) structure is modelled as a single DOF

system (Figure 14) and different displacement profiles are accounted for according to the failure mechanism or displacement profile at a given limit state, while using the geometric and material properties of the structures within a building class. For reinforced concrete frames, the displacement capacities of column-sway (soft-storey) and beam-sway (distributed damage) failure mechanisms are considered (see Figure 15) whilst for masonry structures different in-plane failure modes have been identified (see Figure 16). This approach is particularly suitable for the loss estimation studies, since, in addition to the direct customisation to any given building stock characteristics, it is computationally very efficient thus allowing extensive and repetitive parametric studies to be carried out in a cost-effective manner.

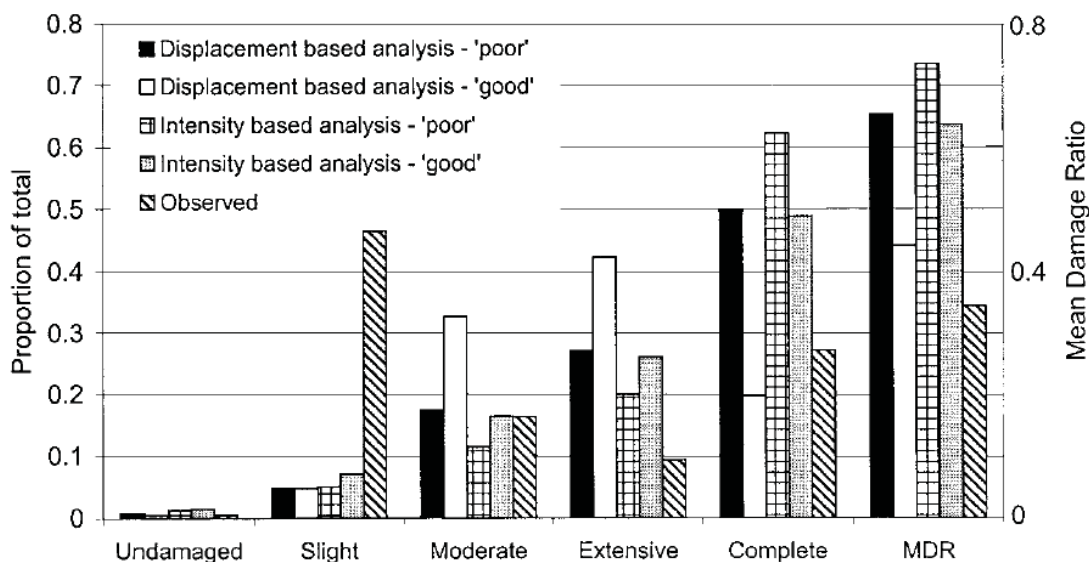

Fig. 13 1999 Kocaeli earthquake, Gölçük Coastal Zone: Results of various analyses and comparison with the damage data for the mid-rise reinforced concrete frames (Spence et al., 2003)

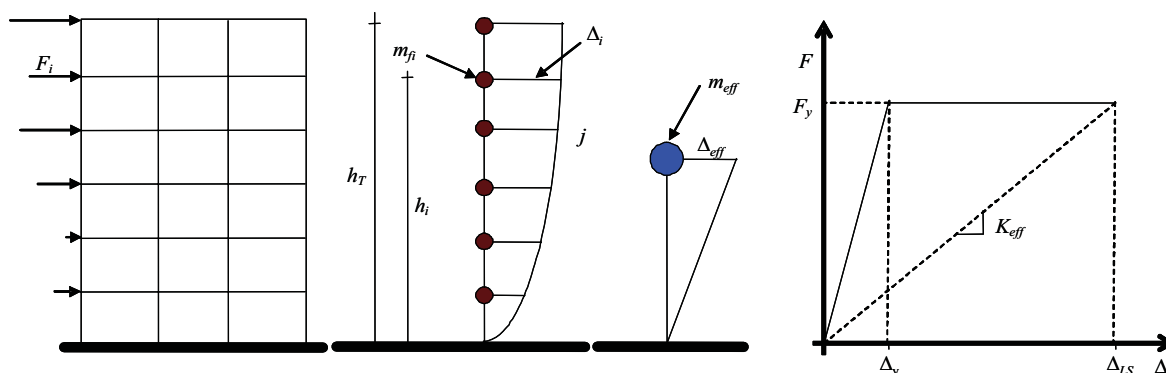

Fig. 14 Simplified model for an equivalent SDOF system

Calvi (1999) considered the inherent variability in the structural properties within an urban environment by assigning maxima and minima to the variables and assuming a uniform probability distribution function. The period of vibration was calculated using the empirical formula in EC8 (CEN, 2003), which directly relates the height of a building to its period; again maxima and minima were applied to the parameters in this equation. The range of the limit state displacement capacity for the building class can be plotted against the range of the period of vibration, as presented in Figure 17. This capacity area can then be directly compared with the displacement response spectrum; the area below the spectrum represents the proportion of buildings failing, or exceeding, the limit state. The displacement response spectra were adjusted to include the nonlinear response, wherein a reduction of the spectral ordinates was applied to account for the energy dissipation capacity of the structure as a function of the target displacement and the structural response.

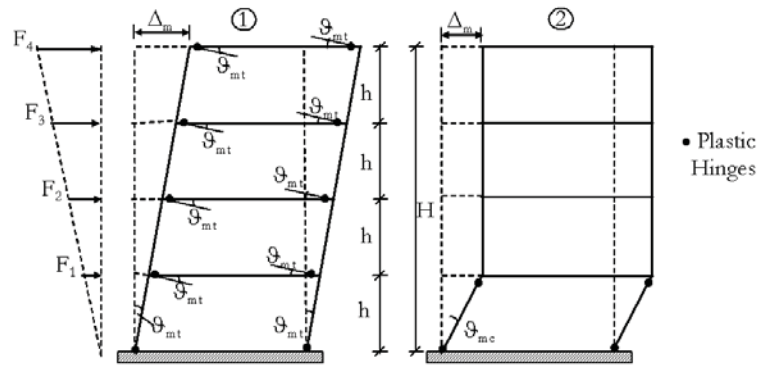

Fig. 15 Distributed damage/beam-sway (left) and soft-storey/column-sway (right) response mechanisms

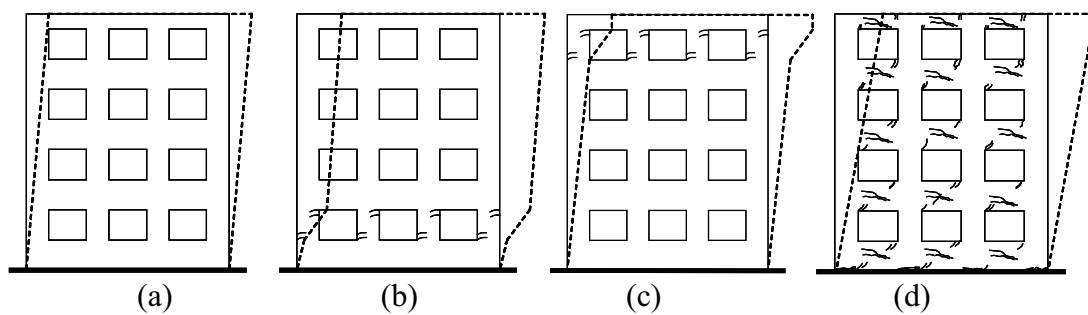

Fig. 16 Deformed shapes for different limit states and in-plane failure modes

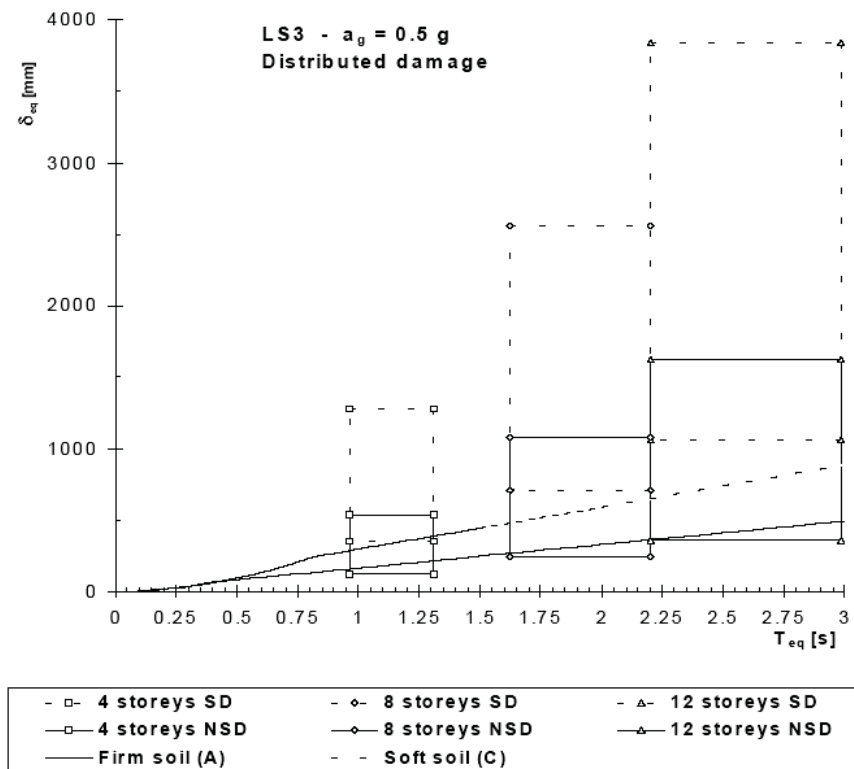

Fig. 17 An example of the intersection of capacity areas and demand spectrum (Calvi, 1999)

The methodology proposed by Calvi (1999) has subsequently been developed for reinforced concrete buildings by Pinho et al. (2002) and Crowley et al. (2004, 2006), leading to the Displacement-Based Earthquake Loss Assessment (DBELA) procedure. For the masonry component of the methodology, a

parallel extensive development was carried out by Restrepo-Vélez and Magenes (2004), Restrepo-Vélez (2005), Modena et al. (2005) leading to the procedure MeBaSe (Mechanical Based Procedure for the Seismic Risk Estimation of Unreinforced Masonry Buildings). A brief description of the main components of both MeBaSe and DBELA is provided in what follows.

Three limit states are considered in MeBaSe for the case of in-plane failure mechanisms, namely *LS1-LS2* for which just slight structural and non-structural damages occur, *LS3* for which moderate structural damage and extensive non-structural damage occur, and *LS4* for which the collapse of the building is considered (Figure 16). Equations (17) and (18) are used to compute the limit state functions for the case of in-plane failure mechanisms, where the vector of random variables can be formed by the total height of the building class, h_t , the height of the openings at the failing storey, h_{sp} , the drift limit at yield, δ_y , the drift limit at the specified limit state, δ_{LS} , the resistant area of the walls in the direction of minimum strength, A_m , the ratio of areas of walls in both directions, γ_m , the referential shear strength of the masonry, τ_{km} , and the correction factor, ϕ_c . This correction factor allows to express the tri-dimensional response of a building by means of a simplified bi-dimensional model, based solely on the shear strength of the walls, and it is computed with Equation (19), where L_w is the length of the piers and L_T is the total length of the perimeter walls.

$$T_{LS} = 2\pi \sqrt{\frac{\kappa_1 h_t \delta_y + \kappa_2 (\delta_{LS} - \delta_y) h_{sp}}{\frac{1}{\phi_c} A_m K_1 \tau_{km} \left(1 + \frac{K_2}{A_m (1 + \gamma_m) \tau_{km}}\right)^{1/2}}} g \quad (17)$$

$$\Delta_{LS} = \frac{T_{LS}^2}{4\pi^2} \frac{1}{\phi_c} A_m K_1 \tau_{km} \left(1 + \frac{K_2}{A_m (1 + \gamma_m) \tau_{km}}\right)^{1/2} g \quad (18)$$

$$\phi_c = 5.53 \frac{\tau_{km}}{\left(\frac{L_w}{L_T}\right)} + 0.46 \quad (19)$$

To define ϕ_c (Equation (19)), different building configurations, from two to five storeys, were analysed with this simplified approach and by using the three-dimensional nonlinear computer code SAM (Magenes, 2000). The buildings were selected while trying to cover a realistic range of number of storeys, structural configurations and lateral strengths. As an example of the analyses, Figure 18 shows the pushover results for a four-storey building obtained with the simplified and the three-dimensional methodologies, and for different values of τ_{km} . In Equations (17) and (18), κ_1 and κ_2 are used to compute the fractions of elastic and inelastic components of the displacements, according to the interstorey heights and the distribution of masses (Restrepo-Vélez, 2005).

Out-of-plane mechanisms, which were not considered by Calvi (1999), have been included in MeBaSe by considering one-way and two-way bending mechanisms, whose dynamic response has been described by Doherty et al. (2002) and Griffith et al. (2003) by means of a tri-linear model.

The main improvements that have been applied to the method by Calvi (1999) for reinforced concrete include theoretically improved structural and non-structural displacement capacity equations for ground shaking, the derivation of an equation between yield period and height for European buildings both with and without infill panels (Crowley and Pinho, 2004, 2006), and the consideration of the vulnerability to liquefaction-induced ground deformations (Bird et al., 2005, 2006). DBELA considers three limit states based on the sectional strains in the steel and concrete, for the case of structural limit states, and on interstorey drifts, in the case of non-structural limit states (Crowley et al., 2004). The structural displacement capacity of reinforced concrete members/structures is derived from the structural mechanics principles; beginning with the yield strain of the reinforcing steel and the geometry of the beam and column sections in the building class, the yield curvature is defined using the relationships suggested by Priestley (2003). These beam and column yield curvatures are then multiplied by empirical coefficients to account for shear and joint deformations to obtain a formula for the chord rotation. This chord rotation is equated to

base rotation and multiplied by the height of the equivalent SDOF system to produce the yield displacement capacity. Post-yield displacement capacity formulae are derived by adding a plastic displacement component to the yield displacement, which is calculated by multiplying the limit state plastic section curvature, the plastic hinge length, and the height or length of the yielding member.

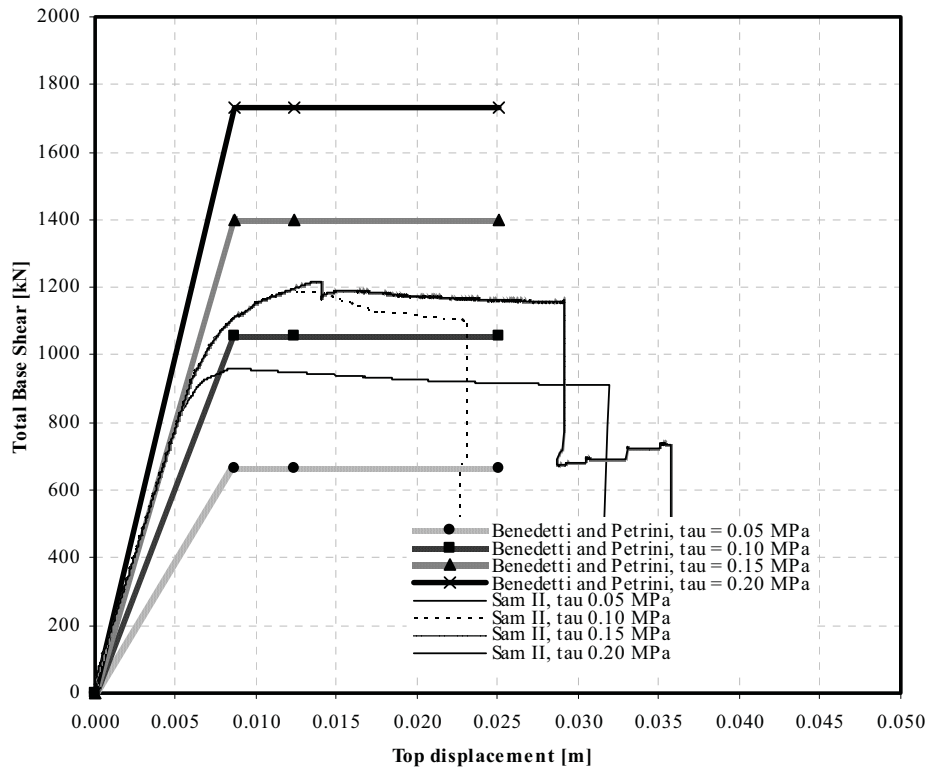

Fig. 18 Pushover results for a four-storey building with the simplified and three-dimensional methodologies, and for different referential shear strength values

When the damage due to liquefaction-induced ground deformations is to be predicted, the displacement capacity is compared directly with the displacement demand imposed on members within the structure. If the damage due to ground shaking is to be considered in the loss model, the displacement capacity equations, which are functions of the geometrical and material properties and the height of the building class, are transformed into functions of period through the substitution of an equation relating the height of a structure to its limit state period. A direct comparison is thus possible at any period between the displacement capacity of a building class and the displacement demand predicted from a response spectrum (Figure 19). For example, the first structural and non-structural limit state capacities to ground shaking for bare beam-sway frames can be predicted using Equations (20) and (21), respectively:

$$\Delta_{Sy} = 5e_{fh}T_y\varepsilon_y \frac{l_b}{h_b} \tag{20}$$

$$\Delta_{NS1} = S\mathcal{G}(10T_y) \tag{21}$$

where e_{fh} is the effective height coefficient, T_y is the yield period of vibration, ε_y is the yield strain of the reinforcing steel, l_b is the length of the beam, h_b is the depth of the beam, S is the shape coefficient relating the roof displacement to the displacement at the centre of the seismic force, and \mathcal{G} is the inter-storey drift capacity of the non-structural elements.

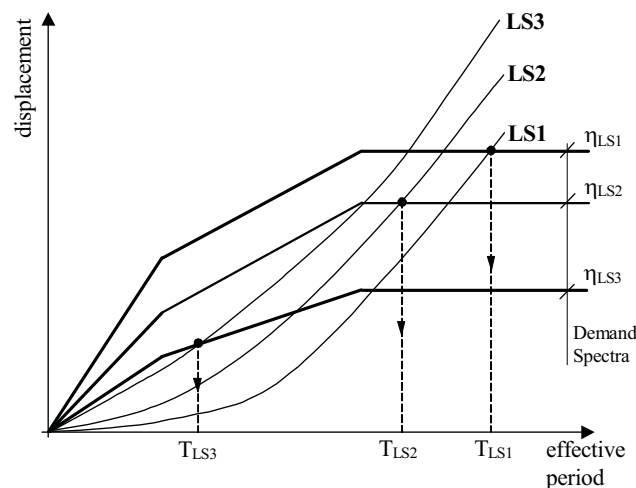

Fig. 19 An illustration of the deterministic comparison of the limit state (LS) displacement capacity and displacement demand in DBELA

One of the principal modifications to the methodology by Calvi (1999) that is common to both DBELA and MeBaSe is the consideration of a joint probability density function (JPDF) of displacement capacity and period (Figure 20(c)). This is calculated from the variability of a vector of random variables present in the equations for displacement capacity, which is conditioned on period (Figure 20(a)) and period of vibration (Figure 20(b)). Furthermore, the variability in the demand response spectrum may also be taken into consideration in the calculation of the probability of exceeding a given limit state.

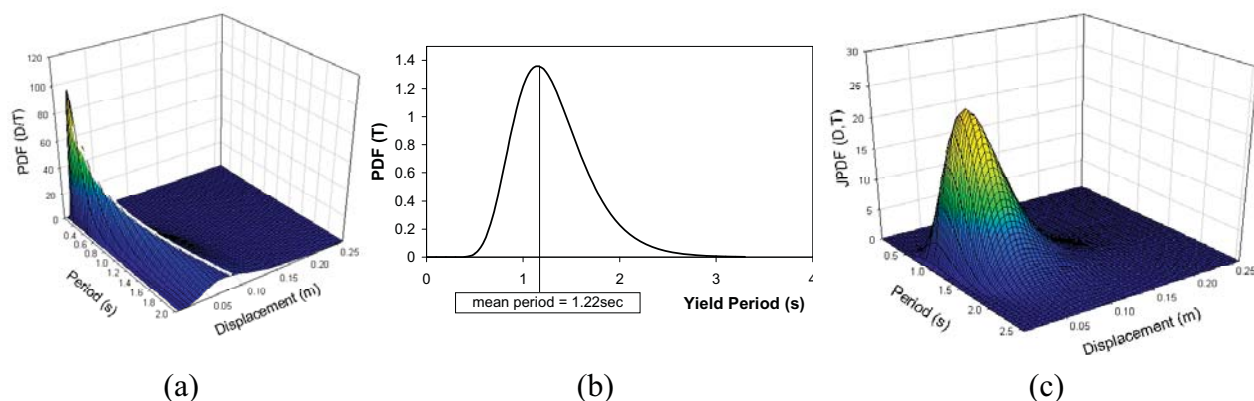

Fig. 20 (a) Illustrative probability density functions of yield displacement capacity, conditioned to period; (b) Illustrative probability density function of yield period for a building class due to variability in structural properties; (c) Example JPDF of capacity for a column-sway RC building class

Notwithstanding its work-in-progress status, the DBELA and MeBaSe methods have already been applied in the assessment of the seismic vulnerability of entire regions (e.g., Restrepo-Vélez and Magenes, 2004; Iaccino, 2004), in the carrying out of important sensitivity studies for definition of priorities in terms of data collection needs (e.g., Crowley et al., 2005), and for the evaluation of different approaches to the definition of the seismic hazard (e.g., Bommer and Crowley, 2006; Crowley and Bommer, 2006). Finally, DBELA has also been proposed as a possible tool for the calibration of future seismic design codes (e.g., Bommer et al., 2005). Future developments which are to be considered include the following: the effect of duration of the demand on the response of structures; the influence of infill panels on the displacement capacity of reinforced concrete frames; the inclusion of model uncertainty due to the simplifying assumptions that have been made in the modelling of RC buildings response; the prediction of acceleration-sensitive non-structural damage; and improvements in the displacement spectra predictions through the consideration of long-period ordinates, near-fault effects, etc. Following the

implementation of the aforementioned developments, it will then be necessary to validate and perhaps even calibrate the methodologies using observed damage data from recent earthquakes.

6. General Evaluation of Analytical Methods

Perhaps one of the main reasons for which the analytical/mechanical methodologies have only recently been proposed for use in risk and loss assessment is due to developments which have occurred in the field of seismic hazard assessment, such as the derivation of seismic hazard maps in terms of spectral ordinates as opposed to macroseismic intensity or PGA. However, the benefits which the use of more advanced seismic hazard and vulnerability models offer need to be weighed against the increased amount of information, and thus time and money, which is required to construct an earthquake loss model based on such analyses. For example, apart from the compilation of databases of building stock inventory (which are required for any loss model), information on the structural characteristics of the building stock is also required in order to calibrate the analytical model, and databases of the earthquake activity, attenuation equations, and ground conditions are needed to carry out a seismic hazard assessment in terms of spectral ordinates. Nevertheless, the use of such detailed and transparent loss models allows detailed sensitivity studies to be undertaken which provide valuable insight into how much the loss results depend on the models, data, uncertainties and assumptions employed.

There are still some outstanding issues with some analytical/mechanical methods which need to be addressed, such as the capability of numerical models to accurately predict the response of real structures; the accuracy in transforming numerical indices of damage into actual damage of real structures; the capability of accounting for human errors in the design and construction of buildings, which are often the main causes of catastrophic collapses; and the need to extend the results obtained for few reference models to a large class of structures, when accurate analyses are carried out.

CONCLUSIONS

A review of some of the most important contributions to the field of vulnerability assessment over the past 30 years has been presented herein. The review has not included all loss estimation procedures, since many are proprietary (Bommer et al., 2006), and others are not easily classified into any of the categories considered herein (e.g., Ordaz et al., 2000). Nonetheless, the authors believe that the most important and most widely used methods for which clear insight into their inner workings is available, have been included.

Following the presentation of the major advantages and drawbacks of each methodology, it may be summarised that an optimal or ideal vulnerability assessment methodology should feature the following main characteristics:

- The most recent developments in the field of seismic hazard assessment should be incorporated.
- All sources of uncertainty should be explicitly accounted for.
- The model should be easily adaptable to the different construction practices around the world, as well as allow for the inclusion of new construction types and the influence of retrofitting on the response of existing structures.
- A balance should be struck between the computational intensity and the amount of detailed data that is required and the consequent degree of confidence in the results.

However, it is unlikely that a single methodology can be produced which fulfils all of these requirements. For example, many analytical/mechanical models, though theoretically superior, require a large amount of detailed data, but the benefit of collecting such data is often not proven through validation of the methodology with empirical methods based on the observed damage data. On the other hand, the derivation of vulnerability curves from the observed data does not always consider the frequency characteristics of the building stock, and the influence of incorrectly modelling the seismic demand experienced by the buildings in the damaged region is normally unaccounted for. Furthermore, many methodologies do not explicitly model the various sources of uncertainty; this can be a problem when, for example, the uncertainty in the seismic demand needs to be removed from the vulnerability assessment calculations. Thus, it appears that the ideal approach for the future needs to be a combination of the positive aspects of different vulnerability assessment methodologies. In other words, reliable

vulnerability assessment of a given region is likely to call for the employment of at least two different approaches, which should complement and/or verify each other.

ACKNOWLEDGEMENTS

We are very grateful to three anonymous reviewers whose thorough and insightful reviews of an initial version of the manuscript led to a significant improvement of the paper. The authors acknowledge the financial support provided by the Italian Ministry of Research and Higher Education (MIUR – Ministero dell’Università e della Ricerca) and the Italian Department of Civil Protection (DPC – Dipartimento della Protezione Civile), through the financing of the following research projects, under the framework of which the current work has been carried out: (i) INGV-GNDT 2000-2003 Framework Programme (Project “Traiano”), (ii) MIUR-PRIN 2004-2006 Framework Programme (Project 2004089099_003), and (iii) ProCiv-INGV 2004-06 (Project S1).

REFERENCES

1. Abrams, D.P. (1992). “Strength and Behaviour of Unreinforced Masonry Elements”, Proceedings of the Tenth World Conference on Earthquake Engineering, Madrid, Spain, Vol. 6, pp. 3475-3480.
2. Antoniou, S. and Pinho, R. (2004). “Development and Verification of a Displacement-Based Adaptive Pushover Procedure”, Journal of Earthquake Engineering, Vol. 8, No. 5, pp. 643-661.
3. ATC (1985). “Earthquake Damage Evaluation Data for California,” Report ATC-13, Applied Technology Council, Redwood City, California, U.S.A.
4. ATC (1988). “Rapid Visual Screening of Buildings for Potential Seismic Hazards: A Handbook”, Report ATC-21, Applied Technology Council, Redwood City, California, U.S.A.
5. ATC (1996). “Seismic Evaluation and Retrofit of Concrete Buildings”, Report ATC-40, Applied Technology Council, Redwood City, California, U.S.A.
6. Barbat, A.H., Yépez Moya, F. and Canas, J.A. (1996). “Damage Scenarios Simulation for Seismic Risk Assessment in Urban Zones”, Earthquake Spectra, Vol. 12, No. 3, pp. 371-394.
7. Bazzurro, P. and Luco, N. (2005). “Accounting for Uncertainty and Correlation in Earthquake Loss Estimation”, Proceedings of the Ninth International Conference on Structural Safety and Reliability, Rome, Italy, pp. 2687-2694.
8. Benedetti, D. and Petrini, V. (1984). “Sulla Vulnerabilità Di Edifici in Muratura: Proposta Di Un Metodo Di Valutazione”, L’industria delle Costruzioni, Vol. 149, No. 1, pp. 66-74.
9. Bernardini, A. (2000). “La Vulnerabilità Degli Edifici: Valutazione a Scala Nazionale Della Vulnerabilità Sismica Degli Edifici Ordinari”, Research Report, CNR-Gruppo Nazionale per la Difesa dai Terremoti, Rome, Italy (in Italian).
10. Bernardini, A., Gori, R. and Modena, C. (1990). “Application of Coupled Analytical Models and Experimental Knowledge to Seismic Vulnerability Analyses of Masonry Buildings” in “Engineering Damage Evaluation and Vulnerability Analysis of Building Structures (edited by A. Koridze)”, Omega Scientific, Oxon, U.K.
11. Bird, J.F. and Bommer, J.J. (2004). “Earthquake Losses due to Ground Failure”, Engineering Geology, Vol. 75, No. 2, pp. 147-179.
12. Bird, J.F., Crowley, H., Pinho, R. and Bommer, J.J. (2005). “Assessment of Building Response to Liquefaction-Induced Differential Ground Deformation”, Bulletin of the New Zealand Society for Earthquake Engineering, Vol. 38, No. 4, pp. 215-234.
13. Bird, J.F., Bommer, J.J., Crowley, H. and Pinho, R. (2006). “Modelling Liquefaction-Induced Building Damage in Earthquake Loss Estimation”, Soil Dynamics and Earthquake Engineering, Vol. 26, No. 1, pp. 15-30.
14. Bommer, J.J. and Crowley, H. (2006). “The Influence of Ground-Motion Variability in Earthquake Loss Modelling”, Bulletin of Earthquake Engineering, Vol. 4, No. 3, pp. 231-248.
15. Bommer, J.J., Spence, R., Erdik, M., Tabuchi, S., Aydinoglu, N., Booth, E., del Re, D. and Peterken, O. (2002). “Development of an Earthquake Loss Model for Turkish Catastrophe Insurance”, Journal of Seismology, Vol. 6, No. 3, pp. 431-446.

16. Bommer, J.J., Pinho, R. and Crowley, H. (2005). "Using Displacement-Based Earthquake Loss Assessment in the Selection of Seismic Code Design Levels", Proceedings of the Ninth International Conference on Structural Safety and Reliability, Rome, Italy, pp. 3567-3574.
17. Bommer, J.J., Spence, R. and Pinho, R. (2006). "Earthquake Loss Estimation Models: Time to Open the Black Boxes?", Proceedings of the First European Conference on Earthquake Engineering and Seismology, Geneva, Switzerland, Paper No. 834 (on CD).
18. Braga, F., Dolce, M. and Liberatore, D. (1982). "A Statistical Study on Damaged Buildings and an Ensuing Review of the MSK-76 Scale", Proceedings of the Seventh European Conference on Earthquake Engineering, Athens, Greece, pp. 431-450.
19. Calvi, G.M. (1999). "A Displacement-Based Approach for Vulnerability Evaluation of Classes of Buildings", Journal of Earthquake Engineering, Vol. 3, No. 3, pp. 411-438.
20. Calvi, G.M. and Pinho, R. (2004). "LESSLOSS. A European Integrated Project on Risk Mitigation for Earthquakes and Landslides", Report 2004/02, European School for Advanced Studies in Reduction of Seismic Risk (ROSE School), Pavia, Italy.
21. Cardona, O.D. and Yamin, L.E. (1997). "Seismic Microzonation and Estimation of Earthquake Loss Scenarios: Integrated Risk Mitigation Project of Bogotá, Colombia", Earthquake Spectra, Vol. 13, No. 4, pp. 795-814.
22. CEN (2003). "Eurocode 8: Design of Structures for Earthquake Resistance – Part 1: General Rules, Seismic Actions and Rules for Buildings", prEN 1998-1 (Final Draft), Comité Européen de Normalisation, Brussels, Belgium.
23. Coburn, A. and Spence, R. (2002). "Earthquake Protection", John Wiley, Chichester, U.K.
24. Corsanego, A. and Petrini, V. (1990). "Seismic Vulnerability of Buildings – Work in Progress", Proceedings of the Workshop II on Seismic Risk Vulnerability and Risk Assessment, Trieste, Italy, pp. 577-598.
25. Cosenza, E., Manfredi, G., Polese, M. and Verderame, G.M. (2005). "A Multi-Level Approach to the Capacity Assessment of Existing RC Buildings", Journal of Earthquake Engineering, Vol. 9, No. 1, pp. 1-22.
26. Crowley, H. (2003). "Periods of Vibration for Displacement-Based Assessment of RC buildings", MSc Dissertation, European School for Advanced Studies in Reduction of Seismic Risk (ROSE School), Pavia, Italy.
27. Crowley, H. and Bommer, J.J. (2006). "Modelling Seismic Hazard in Earthquake Loss Assessment with Spatially Distributed Exposure", Bulletin of Earthquake Engineering, Vol. 4, No. 3, pp. 249-273.
28. Crowley, H. and Pinho, R. (2004). "Period-Height Relationship for Existing European Reinforced Concrete Buildings", Journal of Earthquake Engineering, Vol. 8, No. 1, pp. 93-119.
29. Crowley, H. and Pinho, R. (2006). "Simplified Equations for Estimating the Period of Vibration of Existing Buildings", Proceedings of the First European Conference on Earthquake Engineering and Seismology, Geneva, Switzerland, Paper No. 1122 (on CD).
30. Crowley, H., Pinho, R. and Bommer, J.J. (2004). "A Probabilistic Displacement-Based Vulnerability Assessment Procedure for Earthquake Loss Estimation", Bulletin of Earthquake Engineering, Vol. 2, No. 2, pp. 173-219.
31. Crowley, H., Bommer, J.J., Pinho, R. and Bird, J.F. (2005). "The Impact of Epistemic Uncertainty on an Earthquake Loss Model", Earthquake Engineering & Structural Dynamics, Vol. 34, No. 14, pp. 1653-1685.
32. Crowley, H., Pinho, R., Bommer, J.J. and Bird, J.F. (2006). "Development of a Displacement-Based Method for Earthquake Loss Assessment", Report 2006/01, European School for Advanced Studies in Reduction of Seismic Risk (ROSE School), Pavia, Italy.
33. D'Ayala, D. and Speranza, E. (2002). "An Integrated Procedure for the Assessment of Seismic Vulnerability of Historic Buildings", Proceedings of the 12th European Conference on Earthquake Engineering, London, U.K., Paper No. 561 (on CD).
34. Di Pasquale, G., Orsini, G. and Romeo, R.W. (2005). "New Developments in Seismic Risk Assessment in Italy", Bulletin of Earthquake Engineering, Vol. 3, No. 1, pp. 101-128.

35. Doherty, K.T., Griffith, M.C., Lam, N. and Wilson, J. (2002). "Displacement-Based Seismic Analysis for Out-of-Plane Bending of Unreinforced Masonry Walls", *Earthquake Engineering & Structural Dynamics*, Vol. 31, No. 4, pp. 833-850.
36. Dolce, M., Masi, A., Marino, M. and Vona, M. (2003). "Earthquake Damage Scenarios of the Building Stock of Potenza (Southern Italy) Including Site Effects", *Bulletin of Earthquake Engineering*, Vol. 1, No. 1, pp. 115-140.
37. Dumova-Jovanoska, E. (2004). "Fragility Curves for RC Structures in Skopje Region", *Proceedings of the 13th World Conference on Earthquake Engineering*, Vancouver, Canada, Paper No. 3 (on CD).
38. Faccioli, E., Pessina, V., Calvi, G.M. and Borzi, B. (1999). "A Study on Damage Scenarios for Residential Buildings in Catania City", *Journal of Seismology*, Vol. 3, No. 3, pp. 327-343.
39. Fah, D., Kind, F., Lang, K. and Giardini, D. (2001). "Earthquake Scenarios for the City of Basel", *Soil Dynamics and Earthquake Engineering*, Vol. 21, No. 5, pp. 405-413.
40. FEMA (1999). "HAZUS99 Technical Manual", Federal Emergency Management Agency, Washington, DC, U.S.A.
41. FEMA (2001). "HAZUS99 Estimated Annualized Earthquake Loss for the United States", Report FEMA 366, Federal Emergency Management Agency, Washington, DC, U.S.A.
42. FEMA (2003). "HAZUS-MH Technical Manual", Federal Emergency Management Agency, Washington, DC, U.S.A.
43. Giovinazzi, S. (2005). "The Vulnerability Assessment and the Damage Scenario in Seismic Risk Analysis", PhD Thesis, Technical University Carolo-Wilhelmina at Braunschweig, Braunschweig, Germany and University of Florence, Florence, Italy.
44. Giovinazzi, S. and Lagomarsino, S. (2001). "Una Metodologia per L'analisi Di Vulnerabilità Sismica Del Costruito", *Proceedings of the X Congresso Nazionale on L'Ingegneria Sismica in Italia*, Potenza-Matera, Italy, Paper No. 121 (on CD).
45. Giovinazzi, S. and Lagomarsino, S. (2004). "A Macroseismic Method for the Vulnerability Assessment of Buildings", *Proceedings of the 13th World Conference on Earthquake Engineering*, Vancouver, Canada, Paper No. 896 (on CD).
46. GNDT (1993). "Rischio Sismico Di Edifici Pubblici, Parte I: Aspetti Metodologici", *Proceedings of CNR-Gruppo Nazionale per la Difesa dai Terremoti*, Roma, Italy.
47. GNDT (2000). "The Catania Project: Earthquake Damage Scenarios for a High Risk Area in the Mediterranean", *Proceedings of CNR-Gruppo Nazionale per la Difesa dai Terremoti*, Roma, Italy.
48. Griffith, M.C., Magenes, G., Melis, G. and Picchi, L. (2003). "Evaluation of Out-of-Plane Stability of Unreinforced Masonry Walls Subjected to Seismic Excitation", *Journal of Earthquake Engineering*, Vol. 7, No. 1, pp. 141-169.
49. Grünthal, G. (editor) (1998). "Cahiers du Centre Européen de Géodynamique et de Séismologie: Volume 15 – European Macroseismic Scale 1998", European Center for Geodynamics and Seismology, Luxembourg.
50. Guagenti, E. and Petrini, V. (1989). "The Case of Old Buildings: Towards a Damage-Intensity Relationship", *Proceedings of the Fourth Italian National Conference on Earthquake Engineering*, Milan, Italy, pp. 145-153 (in Italian).
51. Hassan, A.F. and Sozen, M.A. (1997). "Seismic Vulnerability Assessment of Low-Rise Buildings in Regions with Infrequent Earthquakes", *ACI Structural Journal*, Vol. 94, No. 1, pp. 31-39.
52. Iaccino, R. (2004). "Probabilistic Implementation of a Mechanics-Based Procedure for Seismic Risk Assessment of Classes of R.C. Buildings", MSc Dissertation, European School for Advanced Studies in Reduction of Seismic Risk (ROSE School), Pavia, Italy.
53. JBDPA (1990). "Standard for Seismic Capacity Assessment of Existing Reinforced Concrete Buildings", Japanese Building Disaster Prevention Association, Ministry of Construction, Tokyo, Japan.
54. Kappos, A.J., Pitilakis, K. and Stylianidis, K.C. (1995). "Cost-Benefit Analysis for the Seismic Rehabilitation of Buildings in Thessaloniki, Based on a Hybrid Method of Vulnerability Assessment", *Proceedings of the Fifth International Conference on Seismic Zonation*, Nice, France, Vol. 1, pp. 406-413.

55. Kappos, A.J., Stylianidis, K.C. and Pitilakis, K. (1998). "Development of Seismic Risk Scenarios Based on a Hybrid Method of Vulnerability Assessment", *Natural Hazards*, Vol. 17, No. 2, pp. 177-192.
56. Kircher, C.A., Nassar, A.A., Kustu, O. and Holmes, W.T. (1997). "Development of Building Damage Functions for Earthquake Loss Estimation", *Earthquake Spectra*, Vol. 13, No. 4, pp. 663-682.
57. Lantada, N., Pujades, L.G. and Barbat, A.H. (2004). "Risk Scenarios for Barcelona, Spain", *Proceedings of the 13th World Conference on Earthquake Engineering*, Vancouver, Canada, Paper No. 423 (on CD).
58. Magenes, G. (2000). "A Method for Pushover Analysis in Seismic Assessment of Masonry Buildings", *Proceedings of the 12th World Conference on Earthquake Engineering*, Auckland, New Zealand, Paper No. 1866 (on CD).
59. Masi, A. (2003). "Seismic Vulnerability Assessment of Gravity Load Designed R/C Frames", *Bulletin of Earthquake Engineering*, Vol. 1, No. 3, pp. 371-395.
60. McCormack, T.C. and Rad, F.N. (1997). "An Earthquake Loss Estimation Methodology for Buildings Based on ATC-13 and ATC-21", *Earthquake Spectra*, Vol. 13, No. 4, pp. 605-621.
61. Medvedev, S. and Sponheuer, W. (1969). "MSK Scale of Seismic Intensity", *Proceedings of the Fourth World Conference on Earthquake Engineering*, Santiago, Chile, Vol. 1, p. A2.
62. Modena, C., Lourenço, P.B. and Roca, P. (editors) (2005). "Structural Analysis of Historical Constructions – Possibilities of Numerical and Experimental Techniques", Taylor and Francis, London, U.K.
63. Molina, S. and Lindholm, C. (2005). "A Logic Tree Extension of the Capacity Spectrum Method Developed to Estimate Seismic Risk in Oslo, Norway", *Journal of Earthquake Engineering*, Vol. 9, No. 6, pp. 877-897.
64. Oliveira, C.S., Ferreira, M.A. and Mota de Sá, F. (2004). "Seismic Vulnerability and Impact Analysis: Elements for Mitigation Policies", *Proceedings of the XI Congresso Nazionale on L'ingegneria Sismica in Italia*, Genova, Italy, Keynote Lecture (on CD).
65. Oliveira, C.S., Mota de Sá, F. and Ferreira, M.A. (2005). "Application of Two Different Vulnerability Methodologies to Assess Seismic Scenarios in Lisbon", *Proceedings of the International Conference: 250th Anniversary of the 1755 Lisbon Earthquake*, Lisbon, Portugal, Paper No. 37 (on CD).
66. Ordaz, M., Miranda, E., Reinoso, E. and Pérez-Rocha, L.E. (2000). "Seismic Loss Estimation Model for Mexico City", *Proceedings of the 12th World Conference on Earthquake Engineering*, Auckland, New Zealand, Paper No. 1902 (on CD).
67. Orsini, G. (1999). "A Model for Buildings' Vulnerability Assessment Using the Parameterless Scale of Seismic Intensity (PSI)", *Earthquake Spectra*, Vol. 15, No. 3, pp. 463-483.
68. Ozdemir, P., Boduroglu, M.H. and Ilki, A. (2005). "Seismic Safety Screening Method", *Proceedings of the International Workshop on Seismic Performance Assessment and Rehabilitation of Existing Buildings (SPEAR)*, Ispra, Italy, Paper No. 23 (on CD).
69. Park, Y.J. and Ang, A.H.S. (1985). "Mechanistic Seismic Damage Model for Reinforced Concrete", *Journal of Structural Engineering*, Vol. 111, No. 4, pp. 722-739.
70. Pinho, R., Bommer, J.J. and Glaister, S. (2002). "A Simplified Approach to Displacement-Based Earthquake Loss Estimation Analysis", *Proceedings of the 12th European Conference on Earthquake Engineering*, London, U.K., Paper No. 738 (on CD).
71. Priestley, M.J.N. (2003). "Myths and Fallacies in Earthquake Engineering, Revisited: The Mallet Milne Lecture, 2003", IUSS Press, Pavia, Italy.
72. Restrepo-Vélez, L.F. (2005). "A Simplified Mechanics-Based Procedure for the Seismic Risk Assessment of Unreinforced Masonry Buildings", PhD Thesis, European School for Advanced Studies in Reduction of Seismic Risk (ROSE School), Pavia, Italy.
73. Restrepo-Vélez, L.F. and Magenes, G. (2004). "Simplified Procedure for the Seismic Risk Assessment of Unreinforced Masonry Buildings", *Proceedings of the 13th World Conference on Earthquake Engineering*, Vancouver, Canada, Paper No. 2561 (on CD).
74. Rossetto, T. and Elnashai, A. (2003). "Derivation of Vulnerability Functions for European-Type RC Structures Based on Observational Data", *Engineering Structures*, Vol. 25, No. 10, pp. 1241-1263.

75. Rossetto, T. and Elnashai, A. (2005). "A New Analytical Procedure for the Derivation of Displacement-Based Vulnerability Curves for Populations of RC Structures", *Engineering Structures*, Vol. 7, No. 3, pp. 397-409.
76. Rota, M., Penna, A. and Strobbia, C. (2006). "Typological Fragility Curves from Italian Earthquake Damage Data", *Proceedings of the First European Conference on Earthquake Engineering and Seismology*, Geneva, Switzerland, Paper No. 386 (on CD).
77. Sabetta, F. and Pugliese, A. (1987). "Attenuation of Peak Horizontal Acceleration and Velocity from Italian Strong-Motion Records", *Bulletin of the Seismological Society of America*, Vol. 77, No. 5, pp. 1491-1513.
78. Sabetta, F., Goretti, A. and Lucantoni, A. (1998). "Empirical Fragility Curves from Damage Surveys and Estimated Strong Ground Motion", *Proceedings of the 11th European Conference on Earthquake Engineering*, Paris, France, pp. 1-11.
79. Scawthorn, C., Iemura, H. and Yamada, Y. (1981). "Seismic Damage Estimation for Low- and Mid-Rise Buildings in Japan", *Earthquake Engineering & Structural Dynamics*, Vol. 9, No. 2, pp. 93-115.
80. Shinozuka, M., Chang, S.E., Eguchi, R.T., Abrams, D.P., Hwang, H.H.M. and Rose, A. (1997). "Advances in Earthquake Loss Estimation and Application to Memphis, Tennessee", *Earthquake Spectra*, Vol. 13, No. 4, pp. 739-758.
81. Singhal, A. and Kiremidjian, A.S. (1996). "Method for Probabilistic Evaluation of Seismic Structural Damage", *Journal of Structural Engineering*, ASCE, Vol. 122, No. 12, pp. 1459-1467.
82. Singhal, A. and Kiremidjian, A.S. (1998). "Bayesian Updating of Fragilities with Application to RC Frames", *Journal of Structural Engineering*, ASCE, Vol. 124, No. 8, pp. 922-929.
83. Smolka, A., Allmann, A., Hollnack, D. and Thrainsson, H. (2004). "The Principle of Risk Partnership and the Role of Insurance in Risk Mitigation", *Proceedings of the 13th World Conference on Earthquake Engineering*, Vancouver, Canada, Paper No. 2020 (on CD).
84. Sousa, M.L., Campos Costa, A., Carvalho, A. and Coelho, E. (2004). "An Automatic Seismic Scenario Loss Methodology Integrated on a Geographic Information System", *Proceedings of the 13th World Conference on Earthquake Engineering*, Vancouver, Canada, Paper No. 2526 (on CD).
85. Spence, R., Coburn, A.W. and Pomonis, A. (1992). "Correlation of Ground Motion with Building Damage: The Definition of a New Damage-Based Seismic Intensity Scale", *Proceedings of the Tenth World Conference on Earthquake Engineering*, Madrid, Spain, Vol. 1, pp. 551-556.
86. Spence, R., Bommer, J., del Re, D., Bird, J., Aydinoglu, N. and Tabuchi, S. (2003). "Comparing Loss Estimation with Observed Damage: A Study of the 1999 Kocaeli Earthquake in Turkey", *Bulletin of Earthquake Engineering*, Vol. 1, No. 1, pp. 83-113.
87. Veneziano, D., Sussman, J.M., Gupta, U. and Kunnumkal, S.M. (2002). "Earthquake Loss under Limited Transportation Capacity: Assessment, Sensitivity and Remediation", *Proceedings of the Seventh US National Conference on Earthquake Engineering*, Boston, U.S.A. (on CD).
88. Whitman, R.V., Anagnos, T., Kircher, C.A., Lagorio, H.J., Lawson, R.S. and Schneider, P. (1997). "Development of a National Earthquake Loss Estimation Methodology", *Earthquake Spectra*, Vol. 13, No. 4, pp. 643-661.
89. Whitman, R.V., Reed, J.W. and Hong, S.T. (1973). "Earthquake Damage Probability Matrices", *Proceedings of the Fifth World Conference on Earthquake Engineering*, Rome, Italy, Vol. 2, pp. 2531-2540.
90. Wood, H.O. and Neumann, F. (1931). "Modified Mercalli Intensity Scale of 1931", *Bulletin of the Seismological Society of America*, Vol. 21, No. 4, pp. 277-283.
91. Yakut, A. (2004). "Preliminary Seismic Performance Assessment Procedure for Existing RC Buildings", *Engineering Structures*, Vol. 26, No. 10, pp. 1447-1461.
92. Yeh, C.H., Jean, W.Y. and Loh, C.H. (2000). "Damage Building Assessment for Earthquake Loss Estimation in Taiwan", *Proceedings of the 12th World Conference on Earthquake Engineering*, Auckland, New Zealand, Paper No. 1500 (on CD).