



Research on the system of smart city park based on cloud computing

Miao Yu¹ · Jinguo Song¹ · Caixia Zhang¹

Received: 16 December 2017 / Revised: 1 January 2018 / Accepted: 5 January 2018
© Springer Science+Business Media, LLC, part of Springer Nature 2018

Abstract

In order to effectively improve the management level and service level of the intelligent park, the information fusion in the intelligent park is studied. First, the main concepts of the Internet of things and cloud computing are discussed. It includes key technology, architecture, application field and key technology of cloud computing, platform architecture and so on. Based on the above, a hardware architecture and technical scheme based on cloud computing, cloud storage and cloud analysis is proposed. The design of the application system, the application support platform, the transmission and the sensors used in the park are discussed. In addition, a software architecture and technical scheme for information intelligent application system based on cloud computing, cloud storage and cloud analysis is proposed. The research target and function design of each application system are studied in detail. Finally, the implementation effect of intercommunication and fusion processing between the systems is analyzed. The results show that the system can effectively solve the information island phenomenon. The introduction of new technology will bring great social and economic benefits for the park. It provides a reference for the development of intelligent cities.

Keywords Cloud computing · Smart city park · Internet of things · Intelligent fusion

1 Introduction

At present, the technology of the Internet of things is still in the primary stage. All kinds of technology need to be developed and perfected. The technology and level of information processing and analysis largely determine the intelligent processing level of the Internet of things [1]. The current technology mainly includes cloud computing, intelligent recognition and other advanced technologies. Among them, the position of cloud computing is especially important, which is the core of the Internet of things. It also promotes the effective integration of the Internet of things and Internet, and further advances the realization of the intelligent earth [2,3].

To build a smart Park, the goal is multifaceted. It is mainly embodied in the following three aspects: First, through the construction of the park's wisdom, the park resources can be effectively integrated. The resources of each unit in the park can maximize its potential. In order to maximize the benefits of the park and the enterprises, the various units in the park

should be avoided to repeat some of the shared park resources [4]. Second, through the information construction of the park, the real time, objective, efficient, multi-platform display and release of the information of the park are realized. The information of the park is distributed according to the different distribution rules, such as units, personnel and other distribution rules, and the information is gradually distributed on demand. Third, by building the intelligent information platform of the park, the original independent information system is gradually unified to an information platform, so that each unit can set up real-time, effective connectivity and monitoring among different units [5]. In conclusion, through the construction of smart parks, some problems such as poor communication, duplication of resources and information island should be solved, so as to achieve the goal of win-win for enterprises and parks [6].

Therefore, on the basis of the information and intelligence of the intelligent park, the Internet of things and cloud computing technology are adopted. An effective solution of the information island is studied and proposed. Through the intellectualized construction of environmental monitoring, transportation, security and information fusion in the park, reliable basic software and hardware, diversified resources and cost-effective services and management are provided.

✉ Caixia Zhang
caixia666@hotmail.com

¹ Business School, China University of Political Science and Law, Beijing, China

2 Method

2.1 Cloud computing

Cloud computing can provide strong technical support for the Internet of things. The key technologies are:

As the most important technical basis of cloud computing, virtualization actually means that the computing unit is based on virtual rather than real hardware [7,8]. Through the use of virtualization technology, corporate resources are properly configured and used. At the same time, resources are rationally allocated to achieve dynamic equilibrium, based on changes in their business needs. This leads to an increase in system reliability due to the hardware independence [9,10]. In real cloud computing applications, services on the cloud are implemented and provided for application through computational virtualization. At present, through the virtualization technology, the application of CPU, OS and server is realized, which greatly improves the efficiency and quality of service [11].

Google search is for global users. Because of its large scale of users, the technology of distribution processing is put forward. With a distributed architecture, millions of common computers work in collaboration. The distributed storage of mass data is realized mainly through the distributed file system. The storage of mass data is implemented through a distributed database. At the initial design, the distributed file system was only provided for the local data in the LAN. DFS extends its service scope to the entire network [12]. It can not only change the way of data storage and management, but also has the advantages of data backup and data security that are not available in the local file system.

Parallel computing is based on a relatively simple preliminary idea. There are several computers can achieve several times the capacity of a single computer. The processing time is reduced to a fraction of a single computer. This is an ideal state. Information exchange and synchronization are usually required [13].

Even so, it can effectively improve the processing performance. Parallel computing needs to take into account the following aspects:

First, by decomposing the work into a discrete part, it can be solved at the same time.

Second, multiple programs and instructions are executed at the same time;

Third, in the case of parallel computing, the time to solve a problem is less than the time under a single resource.

In general, parallel computing is relative to serial computing. Parallel computing is divided into time and space parallel computing. Time-parallel computing usually refers to the pipeline technology. Spatial parallelism is through the parallel use of many processors to calculate.

Because its model is an Internet-based computing model, related services provided by cloud computing inevitably involve information security issues such as information leakage, illegal theft, virus attacks, security breaches and so on [14]. At present, cloud security has developed to the third generation of trusted cloud security phase. It is characterized by automatic security detection and automatic defense on Internet. The client can be configured to be very small, thus improving the performance and reducing the resource consumption [15].

The intelligent campus information cloud service platform architecture is mainly composed of five levels, namely IaaS layer, PaaS layer, SaaS layer, operation management layer and user layer.

The IaaS layer encapsulates basic resources such as hardware devices into services for use by users. Among IaaS, to the user, it would seem that almost everything can be done using bare-metal and floppy disks, running different OSs like Windows, Linux, and so on. In this layer, the basic resources such as hardware are encapsulated, so that the service is provided to the user. The biggest advantage of this layer is the dynamic application and release of the corresponding node. The billing is carried out according to the amount of users' use. IaaS is run on a number of hundreds of thousands of servers. For users, service resources are almost infinite. IaaS can be shared by many users, to achieve high efficiency [16].

PaaS, Platform as a service, the server platform or the development environment is used as a service to provide external.

SaaS, Software as a service. The management software and its related data are concentrated in the cloud. When using the software, the user only needs to use it over the internet without having to install the software.

In addition, some cloud-based OSs have emerged in recent years. For example, Windows azure is a cloud-based operating system from Microsoft. The main purpose of this OS is to provide a platform for software developers. It helps to develop applications that run on cloud servers, data centers, the Web, and PCs. This service platform enables software developers to effectively leverage the familiar tools and technologies (such as Microsoft .NET Framework, Visual Studio, etc.), to fully exploit the flexibility of application development.

2.2 Middleware

Middleware technology is an independent software or service program. It is in the middle of the system architecture, between hardware/OS and top-level applications. In practical application, it often happens that a plurality of middlewares are combined together to realize the corresponding function. Middleware technology can effectively reduce the data processing load from the upper layer, making the heteroge-

neous environment effectively shielded, thus improving the portability of the related systems [17]. Middleware has its distinctive features:

First, it has the ability to meet the needs of different applications.

Second, it can run on a variety of hardware platforms and operating systems.

Thirdly, through the support of distributed computing, the application support and service provisioning across hardware platforms, cross-operating systems and different networks are realized.

Fourth, the standard agreement must be supported.

Fifth, the standard interface must be supported.

As middleware has a strong cross-platform and operating system capabilities, it plays an important role in the software in multi-platform applications. At present, it has become an important part of the standardization work. The middleware can not only greatly reduce the development cycle of the application system, but also effectively reduce the maintenance and operation cost of the application system, thereby reducing the time and cost for the rapid development of the system. Regardless of how the underlying application or underlying hardware system changes, the middleware only needs to be updated accordingly and the exposed interface name remains the same. Other software system almost does not need any changes. It greatly enhances portability [18].

Middleware technology is an ideal choice for cross-platform applications across operating systems and even databases. Middleware technology enables the effective integration of information from existing systems. It does not need to change the original system and build a comprehensive and sound integrated information system. Various software and information systems are organically integrated into a collaborative system. In the process of setting up different units across platforms, the status of middleware technology can be considered as pivotal and pivotal, making it possible to efficiently analyze data and publish information in an integrated manner. When selecting middleware, it is necessary to fully consider the actual demand of information platform construction and the need of future development and expansibility. Generally, middleware (such as CORBA, J2EE, DOOM, etc.) that are more mature and conform to common standards is adopted.

2.3 Internet of things architecture

Generally speaking, the Internet of things is divided into three layers: the perception layer, the network transport layer and the application layer.

The perceptive layer obtains the corresponding information through the perception of the surrounding environment and the specific situation, thus providing the data base for the later intelligent processing of the Internet of things.

Comprehensive and accurate information perception makes it possible for the intelligence of the Internet of things to be intelligentized. Through the deployment of different networks, such as WSN, Internet, wireless transmission network, the perceived information is promptly and effectively sent to the central processing center.

The perception layer is the core of the Internet of Things, through which information is collected. This layer, like human skin and facial features, explores objects and environments through different senses and tactile sensations to gain the appropriate information.

Usually, this layer will set the corresponding sensor according to different applications. For example, temperature and humidity sensors are used to sense the ambient humidity and temperature. The weight sensor is used to sense the weight of the car. GPS terminals are used to sense the current location information. Camera is used to sense dynamic video information.

In general, the perception layer consists of two parts: the front-end sensor and the sensor transport network. Sensors get the corresponding information transmitted through the transmission network to the central processing unit.

The main function of network transmission layer is to realize the transmission of data and information in Internet of Things. In the current stage, the most common and widely used transmission networks are the Internet, various wireless communication networks (microwave networks, satellite networks, Wimax, wireless clusters, etc.), wired communication networks (optical networks, cable networks, etc.).

Internet is widely used. Through the IP address and the hardware address, the identification of the computer address is realized. Wireless networks are usually suitable for short-term construction to be completed and the infrastructure is not perfect situation. The opening cycle is short, and the construction cost is relatively low. However, relative reliability is slightly worse, and the reliability of some wired networks is higher. The cost of construction in the early stage is high and the construction period is long. The appropriate network can be selected according to different circumstances.

At present, M2M is widely used, that is, the interaction between machines and machines. There are commonly used ways to have machines to machines, machines to mobile terminals. It is also possible to achieve a highly reliable network with low costs.

How to reflect the intelligence of the Internet of things, for people, the most intuitive is the application layer. A large amount of data is obtained through the perceptual layer. Through the transmission network, it reaches the central data processing center. By means of intelligence, such as the support of algorithm library, the same event is coordinated and communicated. A comprehensive information set is formed, to provide auxiliary decision suggestions. It is

often necessary to save the collection of massive data, intelligent computing, and mining key information and so on.

At present, cloud computing is based on the Internet. It can provide efficient, rapid and accurate data processing and computing services. The benefits of “cloud” in data processing and analysis can be enjoyed by the vast majority of Internet users with flexible scalability. According to different needs, cloud services can be flexibly configured to provide on-demand services, which are suitable for the requirements of the Internet of Things.

The emerging IoT applications in today’s society mainly include: demonstration projects built by the government in response to development needs, joint ventures of multi-enterprises, and demonstration projects of social life. By reconstructing a large number of networks or deploying mass sensors (cameras, environmental sensors, etc.), the shortcomings of the previous system information are intended to solve.

2.4 Component technology

The component software architecture can effectively improve the system structure and understanding ability of the related software designers, so as to effectively reduce the development cost of software, shorten the development cycle and improve the efficiency of software production.

UML, namely unified modeling language, has the characteristics of simplification and unification. It can effectively express static and dynamic information in software design stage, with intuitive interface and clear information. The modeling language can be applied throughout the design cycle, to adapt to software development from requirements specification each period until after the completion of system testing. It can help software developers to shorten the design cycle and reduce the development cost, and reasonably divide hardware and software.

The goal of UML is to describe any type of system in an object-oriented graph, which has a wide application field. The most commonly used model is software system, but it can also be used to describe systems in non-software domain, such as mechanical system, enterprise organization or business process, and information system dealing with complex data, and industrial system or industrial process with real-time requirement. In general, UML is a common standard modeling language that can be used to model any system with static structure and dynamic behavior.

In addition, UML is suitable for different stages of the system development process from the requirement specification to the test after the system is completed. In the requirement analysis phase, use cases can be used to capture user requirements. Through use case modeling, the external role of the system and the functional requirements of the system (use case) are described. The analysis phase is mainly concerned with the main concepts in the problem domain

(such as abstractions, classes, objects, etc.) and mechanisms. These classes and the relationships between them need to be identified and described with UML class diagrams. In order to implement use cases, there is a need for collaboration between classes, which can be described with a UML dynamic model. In the analysis phase, only the object of the problem domain (the concept of the real world) is modeled, and the classes of technical details in the software system (such as classes dealing with problems such as user interfaces, databases, communications, and parallelism) are not defined. These technical details will be introduced during the design phase, so the design phase provides more detailed specifications for the construction phase.

3 The hardware architecture and design scheme of the intelligent city park system

3.1 Design of intelligent environment monitoring software system

The intelligence park information system architecture is based on the architecture of the ITU (International Telecommunication Union). The technical framework of the Internet of things includes the perceptual layer technology, the network layer technology and the application layer technology. The construction of system architecture is based on three layers of architecture of perception, network and application, which can achieve interoperability and resource sharing under the unified standard. Through the deployment and setting of many types of sensors, the information in the park can be quickly and multi-directionally transmitted to the application system through various transmission networks, and the relevant information is generated and displayed and processed by each application system. The system architecture is shown in Fig. 1.

3.2 Design of application system

By monitoring the environmental monitoring units and modules (smog, harmful gases) in the park, the environmental information (temperature, humidity and harmful gas content) in the parks is monitored in real time. Through the transmission network, it is aggregated to the application support platform.

The environmental monitoring system consists of two parts: environmental data collection and environment related data receiving and processing. Among them, the environmental data acquisition part contains two parts of the sensor and wireless transmission. The data reception processing section includes the wireless data reception processing. The sensors of the nodes arranged in the park are collected by the transmission system and sent to the environment data processing

Fig. 1 Information system architecture of intelligent park

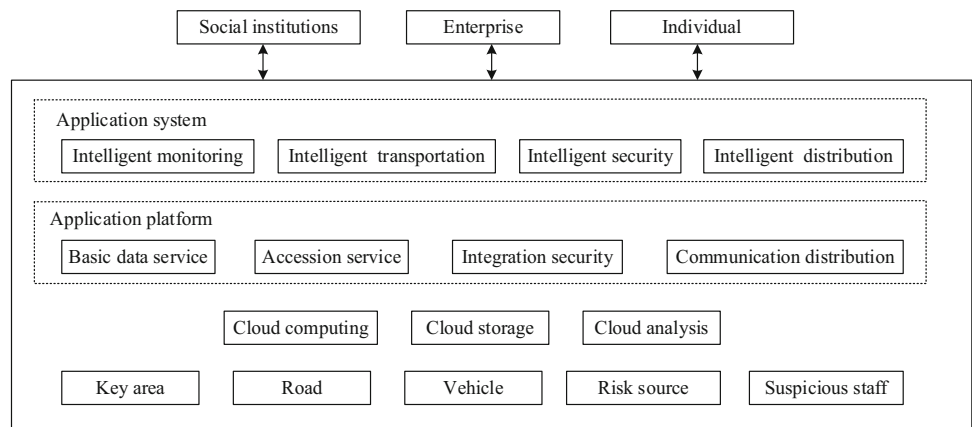
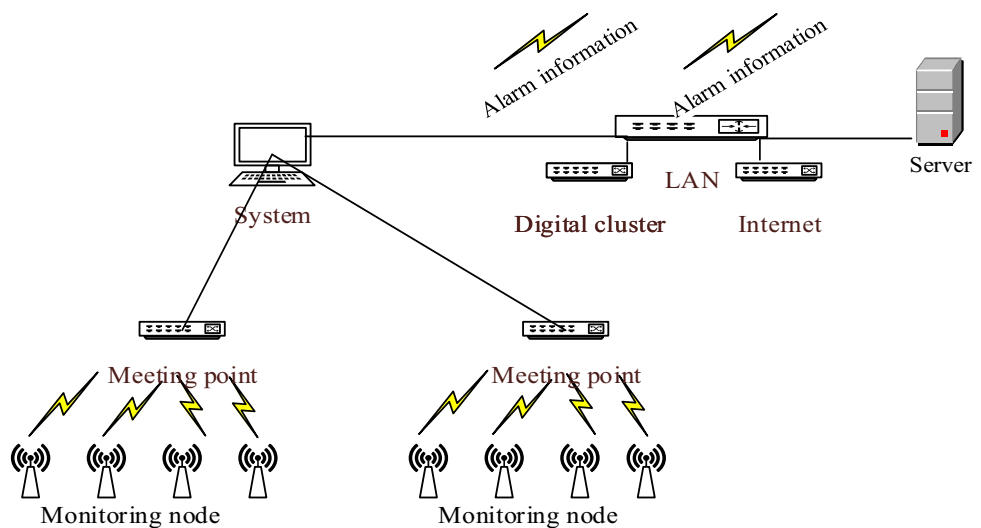

Fig. 2 The schematic diagram of the intelligent environmental monitoring system



section. In the environmental data processing section, it is processed and analyzed. If the environmental data is out of the safety range, the relevant operation will be triggered automatically. It sends alarm information to the relevant manager and system by the transmission system. The corresponding video camera is invoked for video viewing by the pre-recorded correlation.

At present, Zigbee technology is mature and widely used, which provides a new way of thought and way for wireless monitoring. In some cases, the amount of data exchange is not very large, and the data format is relatively simple, then Zigbee technology is very suitable for such occasions. Generally, the Zigbee wireless sensor network is usually composed of the following components: processing computer, signal collector and acquisition terminal. Among them, the acquisition terminal is used to collect the wireless data, and is responsible for the sensing and processing of the data as nodes. In a distributed environment, the signal collector is responsible for sending the RF signals to each node and sending the information to the processing computer through the RS-232 serial port. The schematic diagram of the intelligent environmental monitoring system is shown in Fig. 2.

By deploying multiple monitoring nodes, the collection of environmental data is realized. The collection of data is sent to the gathering node by the wireless Zigbee technology. Then, through wired or wireless networks, the data is pooled into the processing system. Data analysis, processing and storage are implemented. The analysis results are used in conjunction with the video network. The analysis results sent to the park management related personnel. It improves monitoring efficiency and staff response speed.

Through the integrated GPS/BeiDou module and RFID module on the vehicle in the park, the real-time situation of each section of the park is generated by monitoring the locations of all the parks in the park in real time and the summary is applied to the application support platform through the transmission network. After certification, park personnel can call real-time information of each section, and then choose the most suitable route or venue for vehicle related operations. Park certified vehicles can be achieved through the RFID certification out of the park without stopping. The schematic diagram is shown in Fig. 3.

The GPSBeiDou module is integrated in the vehicle to realize the real-time monitoring in the park. When traffic

Fig. 3 The schematic diagram of intelligent transportation system

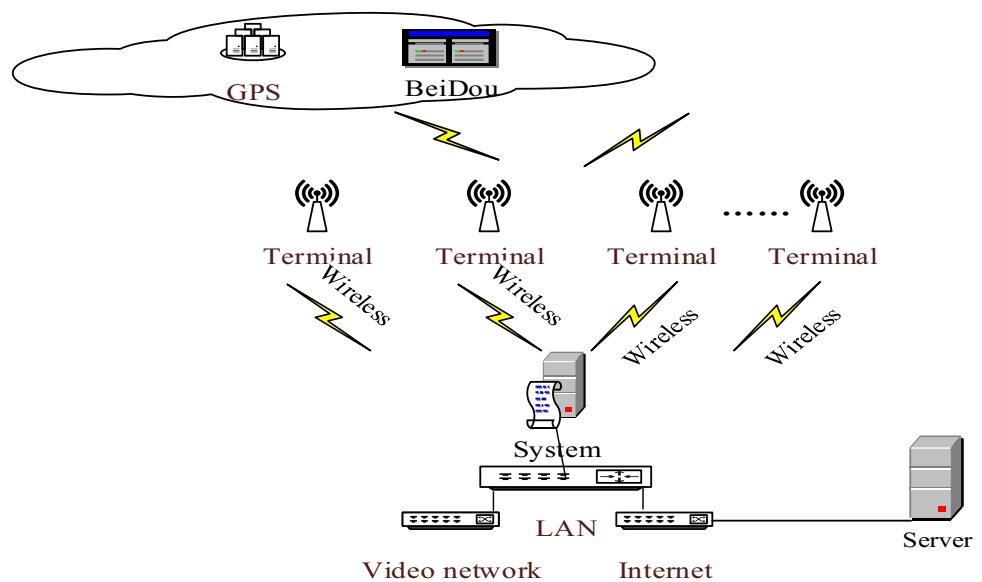

congestion occurs in the park, congestion information can be sent to the related personnel in the park timely by using the digital cluster and integrated communication platform, so that the congestion of the park can be effectively processed.

Intelligent security refers to the video monitor in the surrounding area of the park. It monitors all sections of the park, buildings and factories in the park in real time. The distribution of all video resources is visually displayed on the GIS map. The operator can quickly open the video images, video surveillance based on GIS map. On the basis of a large number of video behavior analysis, the utilization and reliability of the system are improved.

Intelligent security is based on video surveillance. The cloud storage platform has a large number of data and a wide range of cloud analysis. The video resources can be comprehensively utilized to achieve intelligent analysis of park area personnel concentration alarm, park boundary illegal stay alert, specific area suspicious items warning prompt. The schematic diagram of the intelligent security system is shown in Fig. 4.

It receives and integrates the information from the intelligent environment monitoring system, such as toxic gas leakage alarm, the traffic accident caused by the intelligent transportation system, and the information of illegal intrusion incidents sent by the intelligent security system. The corresponding measures should be taken after the confirmation of communication with the guard of the park.

Through the intelligent integration system in the park management center, multi-angle and multi-directional information fusion in the park is realized, which makes the generated information more comprehensive and timely. Through interconnecting and interacting with many related departments in the park and municipal police system, hospitals and

other departments, the emergency is dealt with quickly, so as to achieve the fastest and effective effect and minimize the harm to the accident. This solves the phenomenon of information isolated in the subsystem. The schematic diagram of intelligent fusion is shown in Fig. 5.

3.3 Application support platform

The application of support platform is the means of cloud computing, cloud storage and cloud analysis. Public basic data information services, public information wireless, cable access services, public integrated information services, and public information exchange services are provided. High definition monitoring, prediction and early warning, intelligent analysis, auxiliary decision-making and intelligent control are realized.

The basic information of public information covers the geographical information of the park, the basic information of the enterprise (name of the unit, legal person, main business, region, departmental composition and contact telephone number), vehicle information, park personnel information, basic information of various sensors sensing, RFID, GPS/BeiDou terminal) and so on. It can provide relevant basic data service on-demand for each application system in time.

It can provide public information access service for park security system, park personnel and social personnel according to different authorities. Through the Internet and the intranet of the park, public information is accessed. The public information access services are provided, including query of park geographic information, information inquiry of settled enterprises, and so on.

Fig. 4 The schematic diagram of the intelligent security system

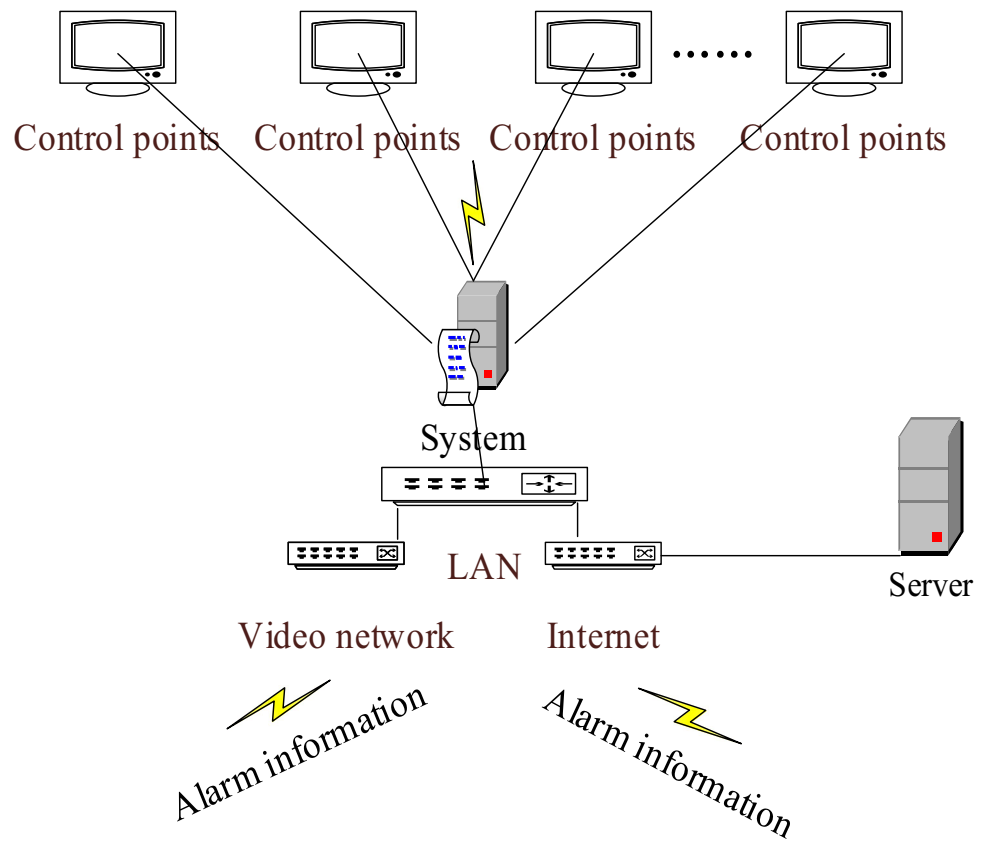
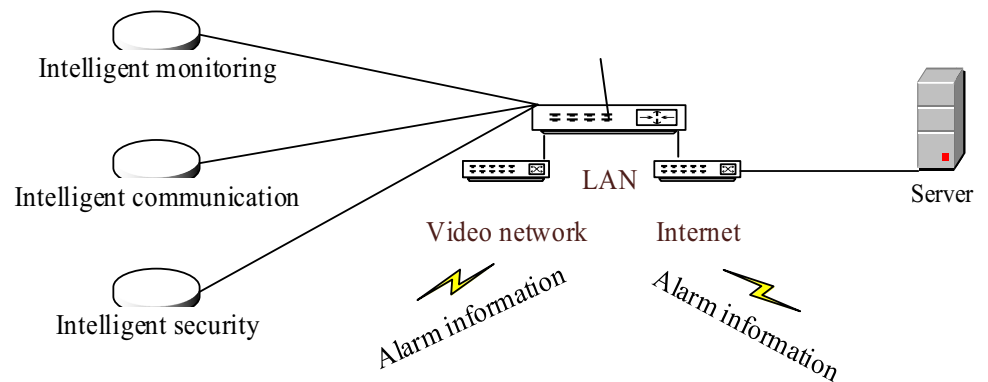

Fig. 5 The schematic diagram of intelligent fusion



For different units and applications of the same site or public information at the same time, it can be effectively integrated according to needs. It generates a comprehensive and comprehensive public information to each application system.

For the same place or public information that is reported by different application systems, different forms and formats of information can be exchanged according to the needs.

3.4 Intelligent park transmission network

The video is arranged at different locations in the different areas of the park. A video special network is set up. The

all-weather video monitoring and control of the park will provide video service for the park security system and realize the intelligent security. According to different areas, video is viewed, and historical data can be retrieved. When a theft or security event occurs, the related video data is used as an important basis.

The wired / wireless special network of information system will be established to interconnect all enterprises and application systems in the park. The broadcasting and information interaction of the public information in the park are realized. By relying on the cluster communication, the wireless special network can be established as a special mobile wireless network for the security of the park.

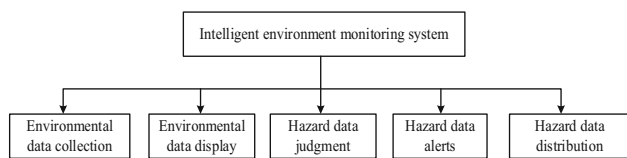

Fig. 6 The software functional architecture of the intelligent environment monitoring software

The site of the park can be established, and the information system of the park can be accessed through the Internet. The key star products and main business information of the enterprise are released to the website, to realize the effective propaganda of the strength of the enterprises and enterprises in the park. Park staff authority management was established. According to different permissions, the corresponding information of the park information system can be accessed.

The AcroTetra digital trunked communication system is based on the latest generation of Softswitch technology and industry-leading software radio technology, which is a 100% TETRA digital trunking system based on IP network architecture. It is highly efficient professional mobile communication system, which is widely used in wireless command scheduling in key areas.

4 The software architecture and design scheme of the intelligent city park system

4.1 Design of intelligent environment monitoring software system

On the basis of fully studying the architecture and workflow of intelligent environmental monitoring system, a system with intelligent environmental monitoring function is proposed to realize real-time monitoring of environmental factors in the park. The software functional architecture of the intelligent environment monitoring software is shown in Fig. 6.

The function structure of intelligent environmental monitoring software includes: environmental data collection, environmental data display, dangerous data judgement, dangerous data alarm, dangerous information distribution. The operating system for developing and running environment is Win7 selected and developed with .Net2010, and the development language uses the Visual C++ language to develop the software. The collection and display of the environment in the park are realized through the software. When dangerous data appear, the warning is made in time through the judgment of the bottom of the software. At the same time, the specific alarm information is generated through the digital cluster and the integrated communication platform to the park staff, in order to quickly deal with the danger.

At present, the function of data acquisition and processing is simple. Smoke sensors are used to monitor toxic gases in the environment. If the smoke sensor detects toxic gases, it triggers the wireless transmission module to send alarm information to the data receiving and processing parts. The temperature sensor sends the information of the real-time environment temperature and other information through the wireless transmission module to the data receiving and processing part. In the intelligent environment monitoring software, the monitoring and judgment of the current environmental data is realized. If the current environmental data conform to the pre-established safety rules (safety temperature, safety humidity, etc.), the data received will be saved to the database and displayed on the software interface. Otherwise, when the harmful gas is detected, the software will automatically carry out the acousto-optic alarm, and send the alarm information automatically through the cluster communication to the related personnel in the park security. Through the integrated communication platform, the alarm information is automatically sent to the management personnel of the park, to ensure the timely handling of the danger.

4.2 Design of intelligent transportation software system

The vehicle terminal integrated GSM module can send the vehicle location information to the intelligent transportation system in real time. At the service side of the intelligent transportation system, the vehicle information collection point is set up, the location information of each vehicle is received in real time, and the vehicle information in the park is displayed on the graphic platform. According to the needs, through the video network, park management personnel can access real-time traffic video information park. Through cloud storage and cloud analysis (according to the driving direction and location information of the vehicle), the possible congestion of each section of the park is predicted in advance. This information is sent to the park traffic management personnel through the digital cluster and the integrated communication platform. The traffic in the park is released to the Internet and can be accessed through the Internet.

The operating system of the development environment and operating environment of Intelligent transportation software is Win7. .net2010 is used for development. The Visual C++ language is selected for the development language.

By setting up the RFID module on the car, it is certified when entering the gate of the park and the vehicle registered in the park. After the success of the certification, the control lever is automatically lifted and released to reduce the manual workload. Figure 7 is a flow chart of vehicle stop registration function.

The RFID terminal is allocated on the registered vehicle in the park in advance and the RFID information is written

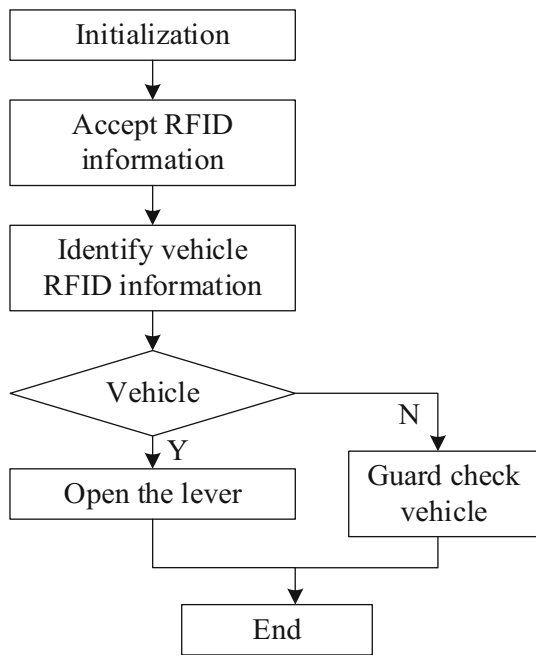

Fig. 7 Vehicle parking registration function

into the system database. RFID receiving terminal is set at the entrance of the park. When the vehicle is near, the RFID information of the vehicle is read, and the starting gear is automatically released when the vehicle is judged to be the vehicle in the park.

There are more and more video sources in modern monitoring and control systems. The number of monitors as a duty is seriously inadequate, and it is not possible to configure too many displays. Even configuration switching devices cannot meet the needs of real-time monitoring. Therefore, the “intelligent behavior analysis” device based on cloud storage and cloud analysis is added to the key parts. It is necessary to warn the abnormal behavior of the traffic situation in the park. When the parking area is monitored, and the vehicle is monitored, the warning and warning are given.

At the same time, when detecting traffic jams and traffic accidents, it directly sends alarm information to the duty seats and reminds the attendants to pay attention to the disposal, so as to avoid the phenomenon of “blindness” observed by the duty personnel for a long time. It greatly improves the efficiency of the system.

4.3 Design of intelligent security system

Using the latest technology and intelligent analysis technology, cloud computing, cloud storage platform, intelligent security system can effectively to park large video surveillance system support, including various sensor access, video data storage and forwarding, intelligent analysis and processing, rapid retrieval and so on. Information systems based on cloud computing can make it possible to quickly respond

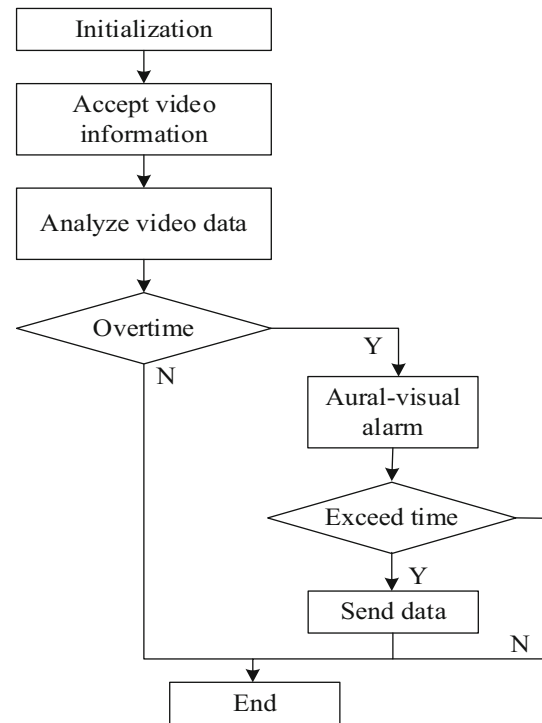

Fig. 8 The flow chart of the software of the electronic Patrol function

to a large number of data service requests. By introducing SOA, the service based video resource application architecture has been built to meet the needs of users in different levels and different levels of park information system in the park, so as to improve the high-speed retrieval ability of massive resource databases. The system is characterized by high reliability. In the process of large capacity video forwarding, storage and processing, pre-established rules are adopted to achieve the functions of electronic patrol, abnormal behavior and item monitoring, and key area monitoring. The park guard is equipped with a cluster of handheld terminals with integrated GPS modules, to realize the deployment of the patrol guard in the park.

The operation system of intelligent security software development environment and operation environment is Win7. .net2010 is selected for development, and Visual C language is used for development language.

The electronic Patrol function is based on the video surveillance network system, which greatly solves the disadvantages of the traditional patrol system. The security personnel of the park will be able to complete the inspection of all the key areas and sections that are monitored in the park. Through this function, the suspect “target” is disposed of in advance. In time, orders are sent to the patrol guard to send the scene to the scene, which greatly improves the speed of the event handling. Its software flow is shown in Fig. 8.

The flow chart of the software for the exception behavior and the item monitoring and reminder function is shown in Fig. 9.

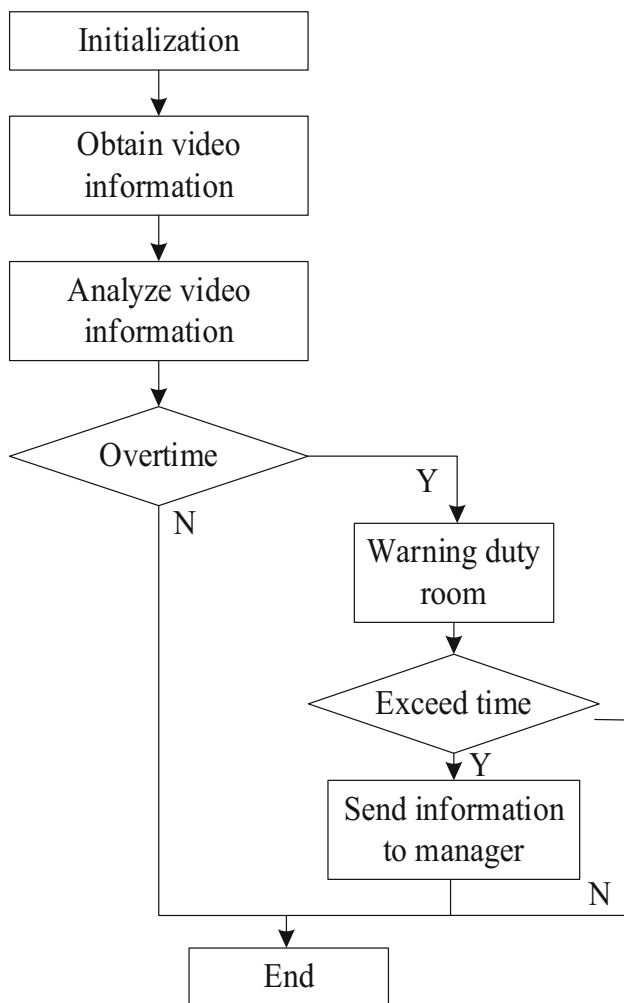

Fig. 9 The flow chart of the software for the exception behavior and the item monitoring and reminder function

Wandering detection: The detection area is delimited. When the target wanders in the area and the time of the target wandering is longer than the residence time set by the system, the system alerts the alert to remind the duty officer to view the relevant information. The legal time length can be set flexibly. If the related duty personnel do not process during the set time, the message is sent to relevant managers through digital cluster and integrated communication platform, so as to prevent the adverse consequences caused by the accident.

Surveillance of suspicious items: When there is an item left in the area and the time when the item is unmanned exceeds the preset time of the system, the system will automatically give an alarm and remind the attendant to check the related information. The legal time length can be set flexibly. If the related duty personnel do not process during the set time, the message is sent to relevant managers through digital cluster and integrated communication platform, so as to prevent the adverse consequences caused by the accident.

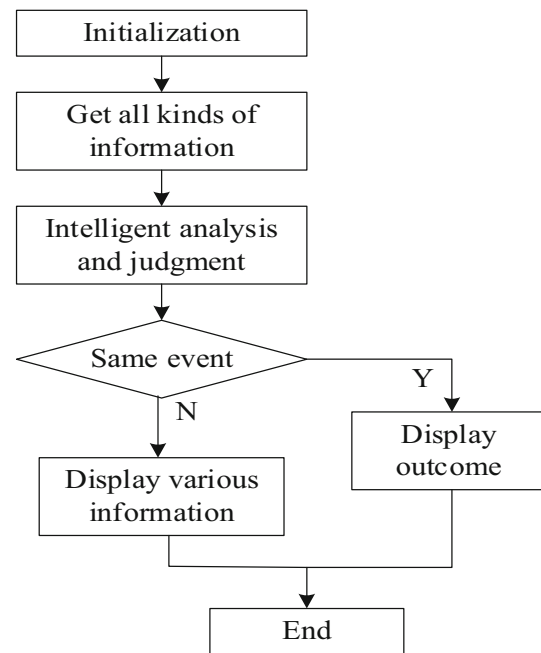

Fig. 10 Intelligent fusion processing function diagram

4.4 Design of intelligent fusion system

Through effective integration of intelligent environment monitoring system, intelligent transportation system and intelligent security system, intelligent identification of the same event can solve the information island phenomenon of the same event, and achieve the full display of the park information.

The operating system of the development environment and operating environment of Intelligent Transportation software is Win7, and .Net2010 is used for development. The Visual C++ language is used to develop the language. The fusion information of the same event is generated by the association judgment of the same event.

The information of the intelligent environment monitoring system, the intelligent transportation system and the intelligent security system is received. Through the predetermined decision rule, the intelligent recognition of the same event, the fusion result and the auxiliary decision plan (need artificial confirmation) are given, to solve the comprehensive information display of the same event. Figure 10 is an intelligent fusion processing function diagram.

When there is a sudden fire and other emergencies, the intelligent environmental monitoring system will give the alarm, call the relevant video surveillance, confirm the fire, and timely contact the fire alarm for disposition. At the same time, the information of the park vehicles sent by the intelligent transportation system is obtained, and the security personnel and related units in the park will be disposed of jointly.

5 Intelligent interconnected park system test

5.1 The composition of the test network

The video server based on cloud computing is selected to realize the effective monitoring of abnormal behavior in the park. The S B421 of the single carrier wave base station of AcroTetra digital cluster is selected as an outdoor base station.

SepuraSRH3800 is selected and the world's leading GPS module is integrated. Even in a building, it can be easier to locate faster than a general GPS receiver. The location sensitivity is -152dbm , and the tracking sensitivity reaches -155dbm . The waterproof and dustproof meet the IEC5291P54 standard. The storage temperature range is -40 to 85°C , the ambient temperature is -20 to 60°C , which can meet the storage and use in low temperature area.

The selected AcroUniteU7200 integrated communication platform is a new type of communication system. Many communication networks, such as wired communications and wireless communications, analog and digital communications, TDM and IP, are integrated into a seamless network. The interconnection and intercommunication between various networks is realized. Thus, the unified command and dispatch can be realized.

The experimental network consists of a LAN environment. Video cloud storage, server and a simulated cloth control point are accessed. Four computers were equipped with intelligent environmental monitoring system software, intelligent transportation system software, intelligent security system software, intelligent integration system.

5.2 Interconnected type park system test

Test content:

Cluster terminal positioning display: Three SepuraSRH3800 digital trunking handheld terminals are numbered A, B and C, respectively. The map of the platform of the intelligent security system is configured. The location information sent by the handheld terminal A, B, and C is received.

Personnel gathering alarm and fusion processing distribution: In the intelligent security seat, the monitoring area is delineated and the upper limit of personnel intensive is 15. When the dispatched personnel intensive more than clever, intelligent security alarm system is given. Traffic information and environmental information dispatched point is acquired. After the fusion process, the integrated information is generated and distributed to the terminal held by the related personnel.

PSTN is interconnected with cluster handheld terminals and mobile phones.

PSTN and the digital cluster handheld terminal A, B, and C are interconnected through the dialing of the dispatcher.

Cluster D interconnects with digital cluster terminals A, B, and C. Cluster D realizes interworking with mobile E.

Test results:

Digital cluster handheld terminal positioning display:

In intelligent security seats, the location information of digital cluster handheld terminals A, B, C and D is received and displayed on the map in real time. The status display is normal, and the location is correct.

Personnel gathering alarm and fusion processing distribution:

When there are more than 15 people in the video screen, the intelligent security system automatically gives the alarm and reports the alarm information (location and number of people gathered to the limit) to the intelligent fusion system. In the intelligent fusion system, the traffic and environmental information of the related location are called through the intelligent transportation system and the intelligent environmental monitoring system. For fusion processing, integrated information is generated. In the form of short message, it is sent to the digital cluster handheld terminal (Intelligent Transportation A, intelligent environment monitoring B, intelligent security system C), digital cluster handheld terminal D (intelligent fusion processing personnel), and mobile E users.

PSTN is interconnected with cluster handheld terminals to implement scheduling. PSTN and the digital cluster handheld terminal A, B, C are interconnected through the dialing of the dispatcher's, and the voice is clear. The cluster D is interconnected with the digital cluster terminal A, B, and C, and the voice is clear. The cluster D realizes interworking with the mobile E, and the voice is clear. Emergencies are handled in time and effectively.

6 Conclusion

As a key technology and core in the Internet of Things, cloud computing has been at the forefront of research all over the world. Many government agencies and IT companies have made research and attempt on their applications and services, which is always a hot spot in the industry. At present, the construction of the intelligent park also needs to break through the aspects of design limitations, information fragmentation, construction hollow, and security vulnerability. There is a common problem in the construction of the intelligent park. It lacks unified planning, and the information construction of the park and enterprise is repeated. A single information island has been formed. Based on the application of the new generation of information technology, such as the Internet of things, cloud computing, large data, and so on, a solution to the intelligent information system is proposed. It tries to make it possible for the smart park to be more real-time, more ubiquitous, and more intelligent. This plan

not only provides effective means to solve the increasingly complex information island disease, but also provides efficient information intelligence ability to improve the precise management and public service level of the park. It creates an intelligent and livable urban environment. Based on the basic framework of Internet of things and cloud computing, and taking into account the information that needs to be shared and exchanged in each subsystem, the sensing data collected by each subsystem is transmitted and interacted, to achieve information exchange and sharing in the park. The purpose of the information integration of the intelligent park is to realize the full interconnection and integration of the information of the park. The island of information has been broken.

Acknowledgements The authors acknowledge Training and Supporting Project for Young or Middle-aged Teachers of China University of Political Science and Law, College Scientific Research Project of China University of Political Science and Law (Grant No. 17ZFG63001), NSF of China (Grant No. L1422009) and “Basic Tasks of Technical forecasting” commissioned by CASTED.

References

- Bera, S., Misra, S., Rodrigues, J.J.: Cloud computing applications for smart grid: a survey. *IEEE Trans. Parallel Distrib. Syst.* **26**(5), 1477–1494 (2015)
- Hamlen, K.W., Kantarcioglu, M., Khan, L., et al.: Security issues for cloud computing. *Int. J. Inf. Secur. Priv.* **4**(2), 36–48 (2015)
- Botta, A., Donato, W.D., Persico, V., et al.: Integration of cloud computing and internet of things: a survey. *Future Gener. Comput. Syst.* **56**, 684–700 (2016)
- Hashem, I.A.T., Yaqoob, I., Anuar, N.B., et al.: The rise of “big data” on cloud computing: review and open research issues. *Inf. Syst.* **47**, 98–115 (2015)
- Panwar, R., Mallick, B.: A comparative study of load balancing algorithms in cloud computing. *Int. J. Comput. Appl.* **117**(24), 33–37 (2015)
- Zhan, Z.H., Liu, X.F., Gong, Y.J., et al.: Cloud computing resource scheduling and a survey of its evolutionary approaches. *ACM Comput. Surv.* **47**(4), 1–33 (2015)
- Baek, J., Vu, Q.H., Liu, J.K., et al.: A secure cloud computing based framework for big data information management of smart grid. *IEEE Trans. Cloud Comput.* **3**(2), 233–244 (2015)
- Zhang, H., Jiang, H., Li, B., et al.: A framework for truthful online auctions in cloud computing with heterogeneous user demands. *IEEE Trans. Comput.* **65**(3), 805–818 (2016)
- Zhang, W., Lin, Y., Xiao, S., et al.: Privacy preserving ranked multi-keyword search for multiple data owners in cloud computing. *IEEE Trans. Comput.* **65**(5), 1566–1577 (2016)
- Bitam, S., Mellouk, A., Zeadally, S.: VANET-cloud: a generic cloud computing model for vehicular Ad Hoc networks. *IEEE Wirel. Commun.* **22**(1), 96–102 (2015)
- Farahnakian, F., Ashraf, A., Pahikkala, T., et al.: Using ant colony system to consolidate vms for green cloud computing. *IEEE Trans. Serv. Comput.* **8**(2), 187–198 (2015)
- Shi, W., Zhang, L., Wu, C., et al.: An online auction framework for dynamic resource provisioning in cloud computing. *IEEE/ACM Trans. Netw.* **24**(4), 2060–2073 (2016)
- Chen, H., Zhu, X., Guo, H., et al.: Towards energy-efficient scheduling for real-time tasks under uncertain cloud computing environment. *J. Syst. Softw.* **99**(2), 20–35 (2015)
- Hameed, A., Khoshkbarforousha, A., Ranjan, R., et al.: A survey and taxonomy on energy efficient resource allocation techniques for cloud computing systems. *Computing* **98**(7), 751–774 (2016)
- Díaz, M., Martín, C., Rubio, B.: State-of-the-art, challenges, and open issues in the integration of Internet of things and cloud computing. *J. Netw. Comput. Appl.* **67**, 99–117 (2016)
- Xiong, J., Liu, X., Yao, Z., et al.: A secure data self-destructing scheme in cloud computing. *IEEE Trans. Cloud Comput.* **2**(4), 448–458 (2015)
- Eludiora, S., Abiona, O., Oluwatope, A., et al.: A user identity management protocol for cloud computing paradigm. *Int. J. Commun. Netw. Syst. Sci.* **4**(3), 152–163 (2015)
- Sookhak, M., Gani, A., Talebian, H., et al.: Remote data auditing in cloud computing environments: a survey, taxonomy, and open issues. *ACM Comput. Surv.* **47**(4), 1–34 (2015)



Miao Yu is a professor working at Business School, China University of Political Science and Law, Beijing, China. He was born in 1970. He has published numerous articles in SCI journals.



Jinguo Song is a master studying at Business School, China University of Political Science and Law, Beijing, China. He is good at cloud computing, mathematical modeling and writing.



Caixia Zhang is a Ph.D. in Business School, China University of Political Science and Law, Beijing, China. She is good at writing and English.