



Alexandria University
Alexandria Engineering Journal

www.elsevier.com/locate/aej
www.sciencedirect.com



ORIGINAL ARTICLE

Nonlinearity analysis in studying shallow grid foundation

A. Ibrahim *, A. Dif, W. Othman

Structural Engineering Dept., Faculty of Engineering, Mansoura University, Egypt

Received 9 April 2016; revised 28 August 2016; accepted 6 November 2016

KEYWORDS

Grid footing;
 Numerical;
 Settlement;
 Nonlinear

Abstract Simulating shallow grid foundation resting on a homogenous C & ϕ soil by different nonlinear finite element analysis types, and estimate the foundation geometry effects on choosing the nonlinear analysis accuracy and degree, will be the main two concerned points through this paper. Almost of the nonlinearity classified agent techniques were mentioned briefly. Through studying the interaction between foundation and soil where the expected penetration may occurs, small and large deformation analysis was performed with a good comparison between their results for various loading levels. The soil material nonlinearity was defined by hardening plasticity cap model while elasticity model was chosen for the foundation. Then the tested variables for grid foundation were performed again on a systemized rectangular raft foundation to discuss contrasts in relative stress distribution inside the soil for the two varied foundation geometries. ABAQUS cae V.6.9.1 was the F.E Program simulation.

© 2017 Production and hosting by Elsevier B.V. on behalf of Faculty of Engineering, Alexandria University. This is an open access article under the CC BY-NC-ND license (<http://creativecommons.org/licenses/by-nc-nd/4.0/>).

1. Introduction

The accuracy of the finite element analysis is still a concerned point although it starts from 30 years ago. This accuracy was classified by Bathe in the nonlinear analysis especially in four classes; (1) small deformation in which; large displacements and rotation occurs but with small strain, (2) large deformation in which; large displacements, rotation, and strain occurs, (3) material nonlinearity, and (4) boundary nonlinearities such as contact and friction [14].

All these classes were widely studied by different techniques one of them was by M. Harnau et al. [9], who defined the large deformation contact analysis by the augmented Lagrangian method through studding structural finite “Solid-Shell” elements, and studied comparison of the contact algorithms used especially for problems in sheet metal forming [9].

Y. Hu and M.F. Randolph performed a numerical method for large deformation problems of soil [13], referred to as Remeshing and Interpolation Technique with Small Strain model (RITSS). Their method was used in pipeline and foundation penetration analyses. The RITSS method is based on a standard small strain algorithm, but with frequent remeshing. They also defined how error estimation and H-adaptive mesh generation techniques can be incorporated into the RITSS approach to reach the accuracy of large deformation analyses

* Corresponding author.

E-mail address: atahrany@hotmail.com (A. Ibrahim).

Peer review under responsibility of Faculty of Engineering, Alexandria University.

<http://dx.doi.org/10.1016/j.aej.2016.11.021>

1110-0168 © 2017 Production and hosting by Elsevier B.V. on behalf of Faculty of Engineering, Alexandria University.

This is an open access article under the CC BY-NC-ND license (<http://creativecommons.org/licenses/by-nc-nd/4.0/>).

of foundations but with optimal meshes to minimize computational times [12,13].

Also, Changxin Wang and John P. Carter defined long deformation analysis by using the Arbitrary Lagrangian-Eulerian (ALE) method which developed by Ghosh and Kikuchi, (1991), though studying the failure mechanism of a horizontally layered cohesive soil under the vertically loaded rigid strip and circular footings [17].

The aim of this paper is to discuss the effect of simulating a real soil foundation problem by different analysis types whether in linear or nonlinear classifications to reach the really and more accurate stress-strain soil behaviors.

As the grid foundation is a special type of shallow foundation, in which the grid shapes has the great effect in transferring the concentrated loads applied on its interactions and load paths, the second aim of this study was generated. It is maintaining that, the loading techniques and the geometry of any foundation are responsible of assigning the required analysis degree.

The theory of interfering foundations was first suggested by Das and Larbi-cherif (1983), where the effect of interference of shear zones on the bearing capacity of footings investigated and limited to parallel strip or rectangular foundations, the concepts of these experiments could be used to investigate any cross shape or grid foundation to explain the soil stresses beneath this foundations and evaluate the soil bearing which depends on the distance between the foundations.

Ghazavi and Hadiani concerned with the foundation geometry during evaluate the ultimate bearing capacity of multi-edge "Cross-shape, H-shape and T-shape" foundation through an experimental laboratory tests. They found that the bearing capacity of multi-edge foundation are generally greater and have a better performance than that of square shaped foundation with the same width [7], because of the interference of shear zones under the collected parts increases the shear resistance for the soil.

M. Ghazavi, S. Mokhtari investigated numerically the behavior of non regular shallow foundations to observe the displacement field under the foundation by using FLAC 3D software. He found that there is a general agreement between numerical and experimental results. But numerical results seem to show slightly more bearing capacity than experimental values [8].

C.M. Martin and Hazell investigated and evaluated the effect of interfering parallel strip footings on the bearing capacity of foundations [15]. And concluded that if the distance between foundations is small the efficiency of interference decreases, but their foundations tend to act as a single one "blocking effect". So the maximum bearing capacity is related to a medium distance between the footings [10].

Hazell, worked on the beneficial interaction that could be quantified in terms of the "efficiency" which refers to the ratio of the overall (group) bearing capacity to the sum of the individual (isolated) bearing capacities, he found that for sand soil the effect of interaction becomes highly significant for friction angles greater than 30° [10].

Kasim also used the main idea of grid foundation interference in soil stabilization techniques by using grid footing composed of open triangular, square or circle cells which are joined together to form a grid in an experimental laboratory tests [14].

2. Linear and nonlinear analysis

2.1. Linear static analysis

Boussinesq's equation for a concentrated point load which used in the approximate solution in linear static analysis, in which, the soil properties does not concerned. This equation as below:

$$\Delta p_z = \frac{3P}{2\pi} \frac{z^3}{L^5} = \frac{3P}{2\pi} \frac{z^3}{(r^2 + z^2)^{5/2}}$$

$$\text{where } L = \sqrt{x^2 + y^2 + z^2} = \sqrt{r^2 + z^2}$$

2.2. Nonlinear static analysis

To establish an appropriate finite element model for nonlinear analysis of an actual engineering problem, three solution variables must be verified; material models, the nonlinear kinematic formulations, and the incremental solution strategies [3].

2.2.1. Simulation material models

In order to constitute stress-strain model of soil behavior, the following requirements must be achieved: (a) an adequate description of main characteristics of elastic-plastic soil behavior, (b) a stable and unique mathematical formulation, (c) along with an efficient performance for numerical implementation. And to ensure the soil description to be with practical characteristics, the soil model should be defined with only a few parameters, whose values are available from standard tests.

These all requirements were handy by Drucker-Prager hardening cap model. Drucker et al., proposed that soil behavior could be modeled as an elasto-plastic strain hardening material and extended Drucker-Prager frictional model with a spherical end-cap, combined with the Drucker-Prager cone. The cap was used to control the plastic volumetric change of soil and location of cap was dependent upon soil density [6,4]. Then very important improvements of the cap model performance was obtained by formulating consistent algorithmic loading-unloading conditions and modifying hardening law to associated one [11].

But the singularity of the tangent operator in the corner regions remains as an additional problem, which causes difficulties in numerical calculation. This problem was solved by introducing circular surfaces on both tension and compression sides, which are used to smoothly intersect the failure envelope, to result a new modified smooth elliptic cap model for soil mechanics discussed by Dolarevic and Ibrahimbegovic, Fig. 1.

They have studied their new model in several numerical examples and provided a very good performance in modeling of both, standard tests and practical problems [5]. The main advantage of this modified smooth cap model is avoidance of corner regions in yield criterion without changing the original material parameters. Therefore this model shows very similar behavior as non-smooth elliptic cap model, and has a quadratic convergence rate.

ABAQUS program contains a similar modified smooth elliptic cap model which has been chosen for this theoretical study [2], Fig. 2.

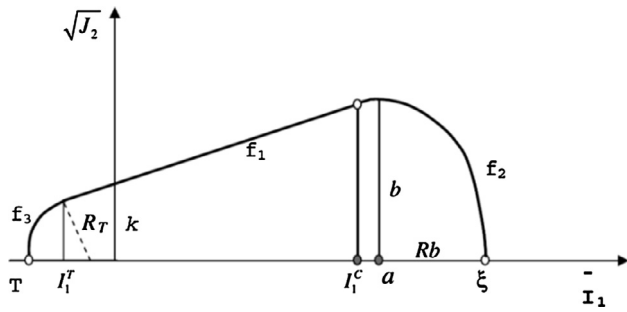

Figure 1 the modified smooth cap model in $I_1 - \sqrt{J_2}$ plane. Where; $f_1(I_1, J_2)$: Drucker-Prager function. $f_2(I_1, J_2, \xi(\epsilon_v^p))$: Strain-hardening elliptic cap function. $f_3(I_1, J_2)$: Cut off plane.

$$F_s = t - p \tan \beta - d = 0$$

$$F_c = \sqrt{(p - p_a)^2 + \left[\frac{Rt}{1 + \alpha - \frac{\alpha}{\cos \beta}} \right]^2} - R(d + p_a \tan \beta) = 0$$

$$= \frac{p_b - Rd}{(1 + R \tan \beta)}$$

$$F_t = \sqrt{(p - p_a)^2 + \left[t - \left(1 - \frac{\alpha}{\cos \beta} \right) (d + p_a \tan \beta) \right]^2} - \alpha(d + p_a \tan \beta) = 0$$

The material cap parameters as used in the research:

- d : Material cohesion.
- β : Material angle of friction.
- R : Cap eccentricity parameter.
- $\epsilon_{vol}^{in}(0)$: Initial cap yield surface position on the volumetric inelastic strain axis.
- α : Transition surface radius parameter.
- K : the ratio of the flow stress in triaxial tension to the flow stress in triaxial compression.

Linear elasticity parameters: E : Young’s modulus, ν : Poisson’s ratio.

The cap hardening parameters: Position of the yield surface in pure hydrostatic compression related to volumetric compressive plastic strain [2].

2.2.2. Nonlinear kinematic algorithms in contact analysis

The contact algorithms are classified into short and long deformation analysis.

1- Short deformation analysis:

Small deformation analysis will be defined in this paper study by the non-frictional contact type with a penalty formulation. In this case no frictional contact is presented but with a suitable penalty parameter \mathcal{E}_p (between 50 and 100 kN/cm³) [9] and this range chosen as; using a smaller value for \mathcal{E}_p the penetration becomes unacceptably large, and for a higher value of \mathcal{E}_p numerical problems appears. By using this contact analysis only small penetration occurs. A lot of investigations about integration rules for penalty based contact formulations can be found in [16].

2- Long deformation analysis:

According to the geometry of grid foundation and during high loading levels, the grid may penetrate the soil beneath as any shallow foundation will behave, so large deformation analysis will be studied for grid and raft foundation in order to reach for the effective simulation to this penetration by Augmented Lagrangian contact formulation.

Traditionally, large deformation problems in solid mechanics have been solved numerically by FE method using a Lagrangian method if geometrically nonlinear behavior is expected, in which material properties, boundary conditions, stress, and strain states can be accurately defined. During large deformation analysis an excessive mesh distortion may occur, which means numerical problems and particularly enlarged effort in the solution process [17]. To avoid the defects of the traditionally Lagrangian method, another method considered

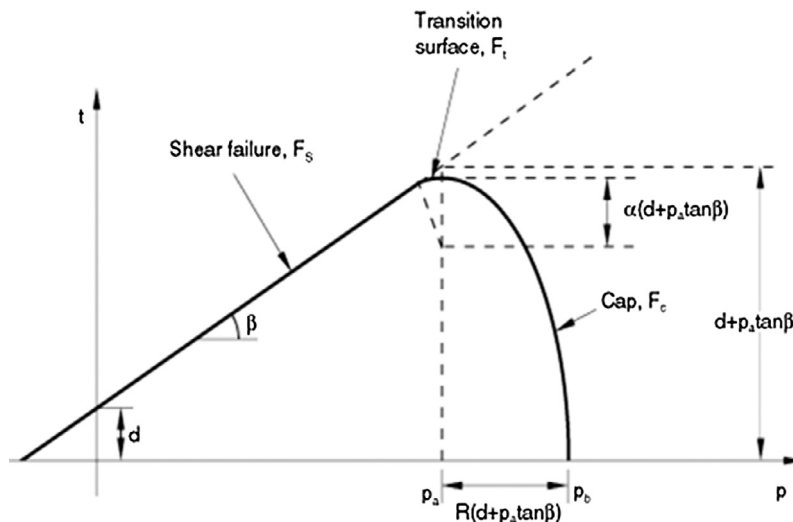

Figure 2 modified Drucker-Prager/Cap model: yield surfaces in the $p-t$ plane, from ABAQUS Finite Element program documentation.

as a combination of the penalty method and the Lagrangian multipliers method named augmented Lagrangian method was chosen.

The augmented Lagrangian method is written in a standard form for a surface contact segment with the gap function and the Lagrange parameters evaluated at the integration points. It must also be mentioned that only linear convergence may be achieved for the augmented Lagrangian parameters inside the augmented Lagrangian iteration algorithm. Therefore many additional iteration steps may be required [9].

2.2.3. Incremental solution strategy

ABAQUS cae. Standard uses Newton's method to solve the nonlinear equilibrium equations. The solution usually is obtained as a series of increments, with iterations to obtain equilibrium within each increment. Increments must sometimes be kept small to ensure correct modeling of history-dependent effects. The choice of the increment analysis size is a matter of computational efficiency as if the increments are too large, more iteration will be required. Furthermore, Newton's method has a finite radius of convergence [1]. Thus, there is an algorithmic restriction on the increment size. The used increment strategy started with a very small increment size and the whole number of increments are very large.

2.3. Finite element meshing

The model meshing needs computational efficiency to achieve the suitable accuracy with the sufficient time and storage capacity of analysis and during this study the finite element soil meshing was concentrated as finer under the grid foundation location, Fig. 4.

3. Model approach

The proposed model for studying grid foundation resting on C and ϕ soil was a 3D model simulation; the soil semi-field is taken as (6.5, 13) times the semi-width of the footing in depth and width respectively, Fig. 3. A relatively fine mesh was used for the long and short deformation analysis, Fig. 4, the soil

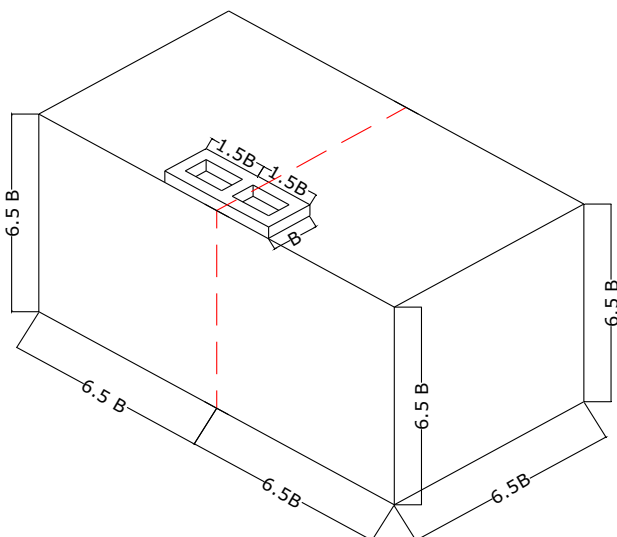

Figure 3 Semi-half of the grid foundation and soil model.

parameter listed in, Table 1. The contact properties illustrated below:

Tangential behavior: was a penalty friction with a friction isotropic coefficient equal 80 [9].

The normal contact behavior: was penalty constraint by allowing the foundation and soil to separate after contact. This was used for small deformation analysis, and augmented Lagrangian standard method with non linear contact analysis was used for long deformation analysis. Where nonlinear effects of large displacements and affects subsequent steps was included in ABAQUS cae [1]. Node-to-surface contact element approach is considered.

4. Methodologies

As mentioned above, the required degree of nonlinearity depends on the case of study; three types of studying were mentioned to discuss the nonlinearity degrees.

First: Grid foundation and rectangular raft foundation were tested for several degrees of linearity and nonlinearity cases:

- Studying the manual linear analysis by Boussinesq's equation.
- Studying linear F.E analysis by assuming the soil and foundation as a one block with no contact in between.
- Studying the material only nonlinearity F.E analysis but by assuming the soil and foundation as a one block with no contact in between.
- Studying the material nonlinearity F.E analysis with small deformation contact nonlinear analysis.
- Studying the material nonlinearity F.E analysis with long deformation contact nonlinear analysis.

Second: Another type of analysis was performed, which consists of comparison between vertical stresses distributed in soil under points of loads. Stresses under grid beams resulted from long deformation analysis compared with that resulted from short deformation analysis.

Third: To insure the effect of using long deformation analysis according to different loading levels, the first was allowable, the third was ultimate loading level, and the second was in between them. These cases of study were performed using short and long deformation analysis.

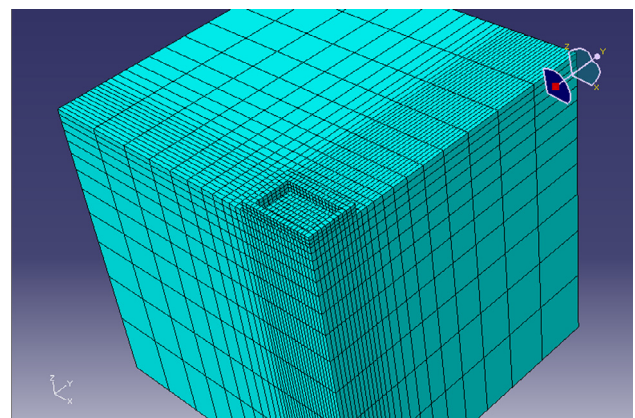

Figure 4 The mesh of soil finer under the grid foundation.

Table 1 Cap soil parameter [10].

E	ν	d	β
12857.14 kN/m ²	0.285	173.21 kN/m ²	30.0°
$\varepsilon_{vol}^{in}(0)$	α	k	R
0.027	0.692	1.0	0.62
p_b	213.0	222.0	242.0
$\varepsilon_{vol}^{in}(0)$	0.00	0.01	0.02
p_b	362.0	522.0	842.0
$\varepsilon_{vol}^{in}(0)$	0.04	0.05	0.06
			14820.07

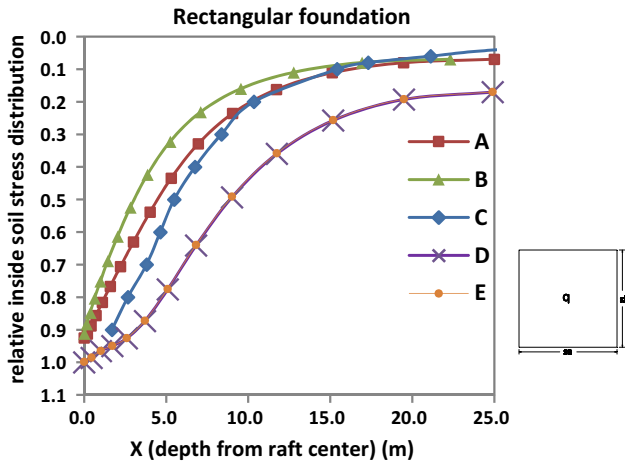

Figure 5 Inside soil relative stress distribution for rectangular foundation type under different types of analysis. Where: A, B, C, D, and E referred to the different cases of study listed in the first methodology.

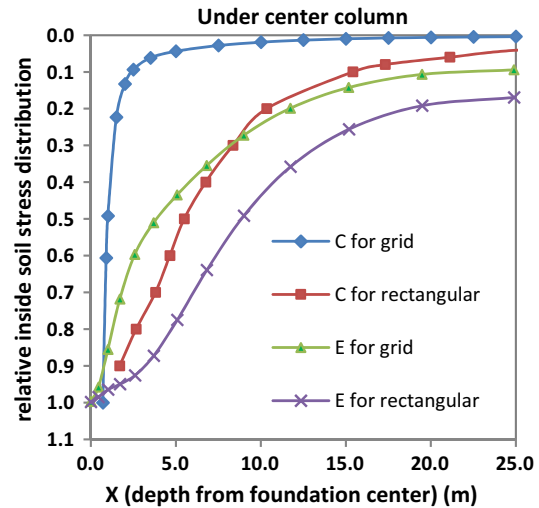

Figure 7 Inside soil relative stress distribution comparison between rectangular and Grid foundation type under different types of analysis.

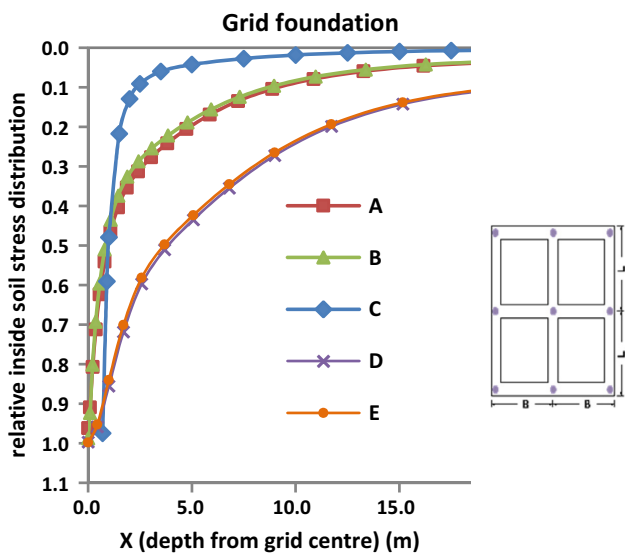

Figure 6 Inside soil relative stress distribution for Grid foundation type under different types of analysis.

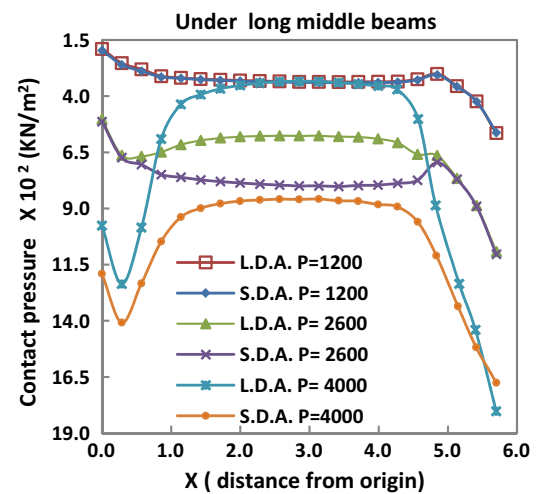

Figure 8 The effect of the deformation analysis type on the contact stress under long middle Grid beam. Where: S.D.A.; and, L.D.A.; short and long deformation analysis.

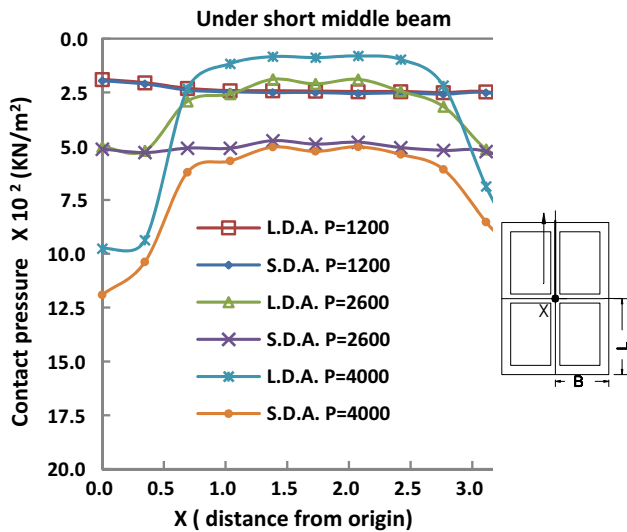

Figure 9 The effect of the deformation analysis type on the contact stress under short middle Grid beam.

5. Results and discussion

When studying the relative inside soil stress distribution, the influence of analysis type was clear in grid and raft foundation. Every case of study resulted in a different relative vertical stress distribution in the soil, but using only nonlinear material are useless if there is no nonlinearity contact analysis between foundation and soil, Figs. 5-7.

Also, the difference value may be neglected in studying rectangular raft and grid foundation if it is performed by long or short deformation analysis. This is for relative vertical stress distribution in the soil under the center of foundation. This was expected as there is no large deformation allowed located under the center points if the loading limited by the allowable level.

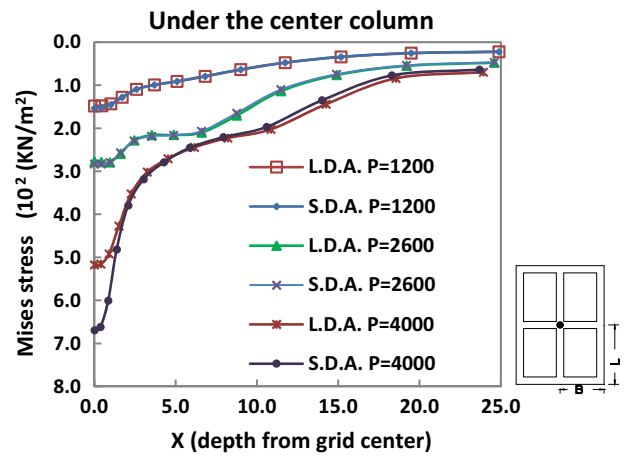

Figure 11 The effect of the deformation analysis type on the settlement under the center column.

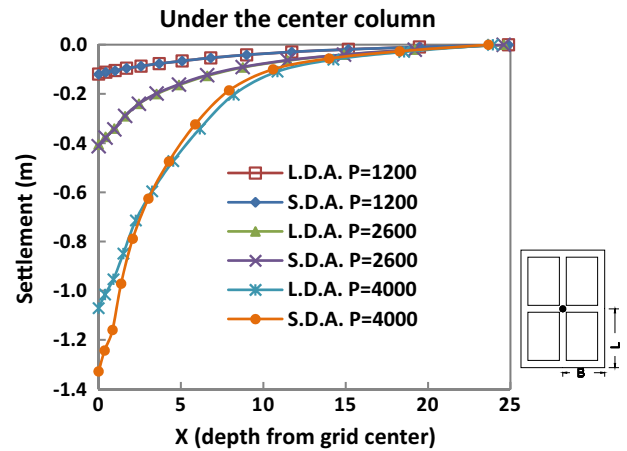

Figure 12 The effect of the deformation analysis type on the inside soil stresses under the center column.

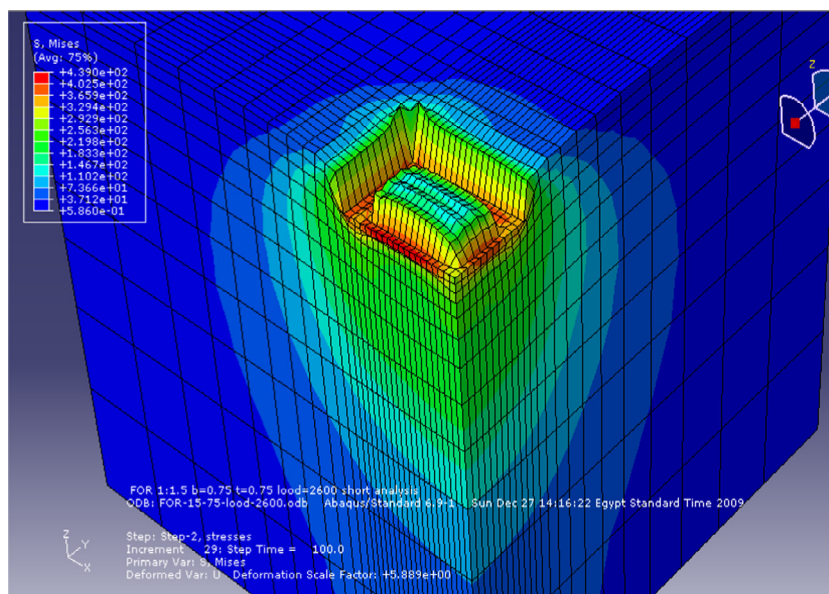

Figure 10 The grid beams penetrated the soil with a great scale factor.

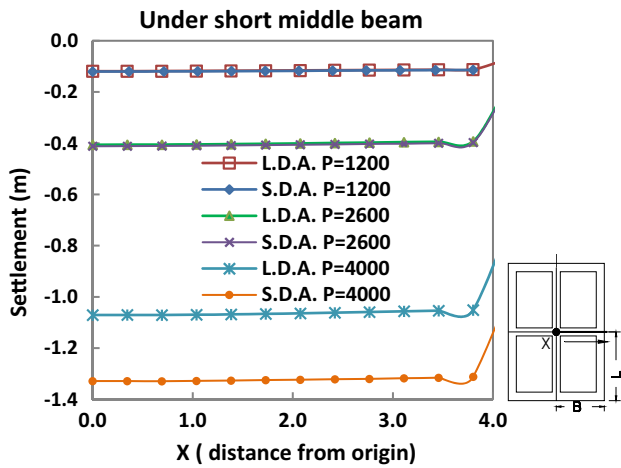

Figure 13 Effect of the deformation analysis type on the settlement under short middle Grid beam.

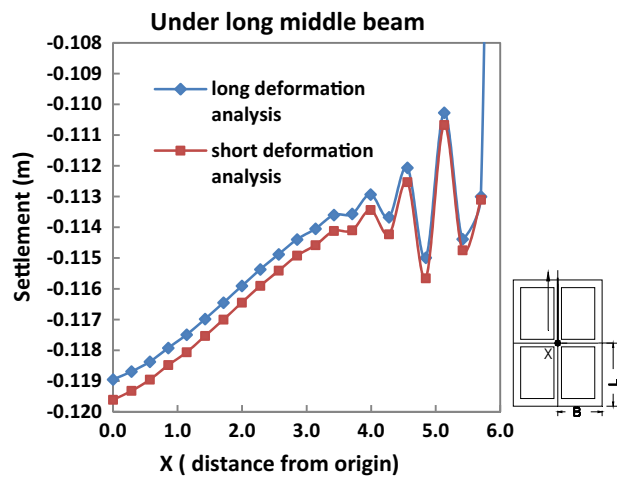

Figure 14 The effect of the deformation analysis type on the settlement under long middle grid beam.

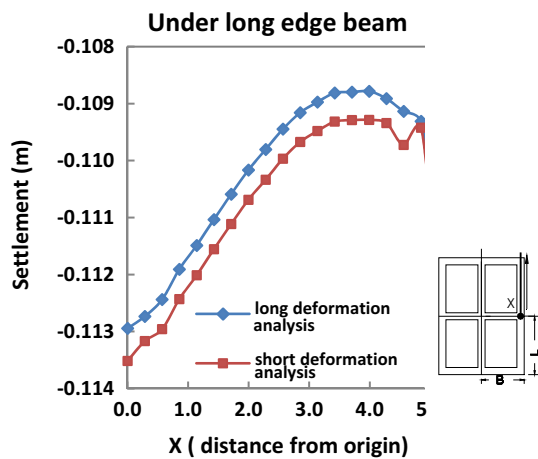

Figure 15 The effect of the deformation analysis type on the settlement under long edge grid beam.

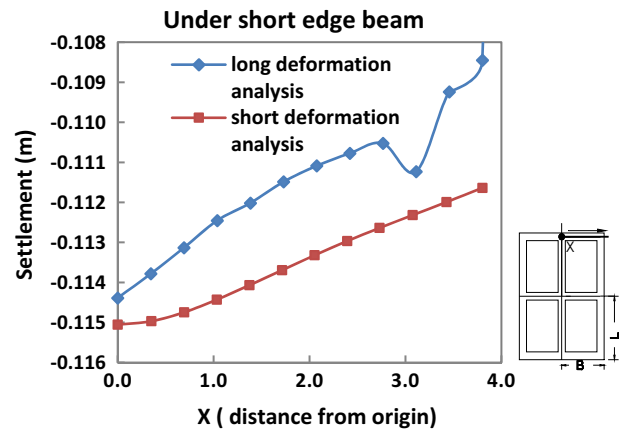

Figure 16 The effect of the deformation analysis type on the settlement under short edge grid beam.

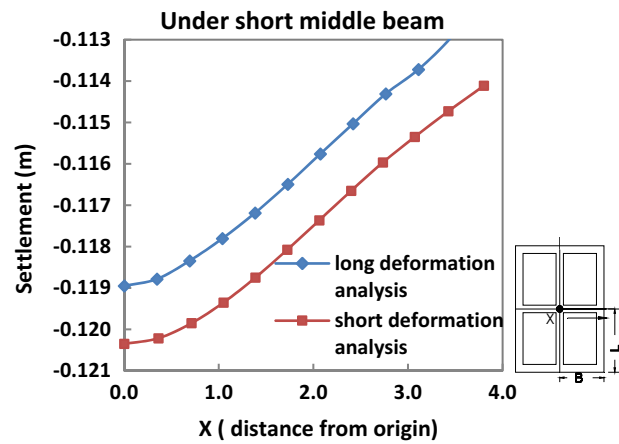

Figure 17 The effect of the deformation analysis type on the settlement under short middle grid beam.

The finite element analysis types have great effects on the settlement, contact pressure, and stress distribution in the soil and under the grid element, especially when loading level is near the ultimate load value, as in Figs. 8, 9 and 13. Also the difference between the contact values, especially the middle beams of the grid when applying ultimate load, was great between long and short deformation analysis, as in Figs. 8 and 9., the contact pressure under the short and long middle beams decreases in the middle of beam by a great value by using “ long deformation analysis”, while all edge beams, either short or long, have small changes by using the two types of analysis, especially when the loading values are relatively small. This point was agreed with the resulted in conclusion by M. Harnau, et al. [9]. that leads in general to differences in the contact stresses, “stress jumps”, between neighboring contact segment between penalty, small deformation analysis and long deformation analysis [9].

The more increasing the loading level, the more increase the contact in points of concentrated loads, and decreases along the grid beam between these points. This difference indicates that the beams role in contact distribution can be neglected relatively in case of studying the ultimate loading. This all depended on the relative rigidity between grid and soil beneath.

When long deformation analysis studied as in Fig. 10 the grid beams penetrating the soil with a great scale factor.

Vertical stresses and settlement under the concentrated load points doesn't have any changes, except for ultimate loading levels and long deformation analysis it decreases Figs. 11 and 12.

All the beams are sensitive to the long deformation analysis except edge beams and the settlement under all middle beams are decreased if using long deformation compared with short deformation analysis results, while the great effects were under short middle beams Fig. 13.

The settlement decreases under all beams (long or short) approximately in the same ratio, when using long and short deformation analysis for all loading levels even when the loading level is at allowable level; Figs. 14-17. along all the different tested four beams; long, short, middle, and edge beams, there is a relative settlement between these beams and for high stiffness grid foundation, this type will be very sufficient for buildings.

Although long deformation analysis effect was significant in ultimate loading case, it has an important role in the contact values in the middle of beams specially the middle beams when the grid beams have different lengths in which their role in load transferring are clear during the maximum allowable loading case.

6. Conclusions

In this study, the first objective is discussing the influence of analysis types "degrees of nonlinearity" on the behavior of grid foundation interacted with soil and spots on the grid beams attitude during the difference between beam lengths in the same grid.

The second objective is showing the difference demonstrated in the relative stress flow distributed under the center of rectangular foundation compared with the other under the same point in grid foundation, when the overall loads are the same, and found that when attending to study the ultimate loading case long deformation analysis and high degree of nonlinearity must be carried out.

Acknowledgement

A greet thankful to D. Prof. Ahmad Al Amin Alnimr and D. Prof. Adel Daif for their supports and encouragements.

References

- [1] ABAQUS 6.9 Documentation, ABAQUS cae User's Manual.
- [2] ABAQUS 6.9 Documentation, Verification Manual.
- [3] K.J. Bathe, *Finite element procedures in engineering analysis*, Prentice-Hall Inc, Englewood Cliffs, New Jersey, 1982.
- [4] W.F. Chen, E. Mizuno, *Nonlinear analysis in soil mechanics*, Elsevier Science Publishers, Amsterdam, 1990.
- [5] S. Dolarevic, A. Ibrahimbegovic, A modified three-surface elasto-plastic cap model and its numerical implementation, *Comput Struct* 85 (2007) 419–430.
- [6] Drucker DC., Gibson RE., and Henkel DJ. Soil mechanics and work hardening theories of plasticity. *Trans, ASCE*.1957; 122:338–46.
- [7] M. Ghazavi, N. Hadiani, *Bearing Capacity of Multi-edge foundations M.Sc. Thesis, University of Technology, Tehran, Iran, 2005.*
- [8] Ghazavi M, Mokhtari S, Numerical Investigation of Load-settlement characteristics of Multi-Edge Shallow Foundations, in: *The 12th International Conference of International Association for Computer Methods and Advances in Geomechanics (IACMAG), Goa, India (2008).*
- [9] M. Harnau, M. Konyukhov, K. Schweizerhof, Algorithmic aspects in large deformation contact analysis using "Solid-Shell" elements, *Comput Struct* 83 (2005) 1804–1823.
- [10] Hazell ECJ, Interaction of closely spaced strip footings. Final year project report, Department of Engineering Science, University of Oxford. 2004.
- [11] G. Hofstetter, J.C. Simo, R.L. Taylor, A modified cap model: closest point solution algorithms, *Comput Struct* 48 (2) (1993) 203–214.
- [12] Y. Hu, M.F. Randolph, Deep penetration of shallow foundations on nonhomogeneous soil, *Soils Found* 38 (1) (1998) 241–246.
- [13] Y. Hu, M.F. Randolph, H-adaptive FE analysis of elasto-plastic non-homogeneous soil with large deformation, *Comput Geotech* 23 (1998) 61–83.
- [14] F. Kasim, Grid mat method to increase the bearing capacity of subgrade soil M.Sc. Thesis, University of Technology, Malaysia, 2007.
- [15] C.M. Martin, E.C.J. Hazell, Bearing capacity of parallel strip footings on non-homogeneous clay. *Frontiers in Offshore Geotechnics: ISFOG 2005 – Gourvenec and Cassidy*, Taylor & Francis Group, London, 2005.
- [16] X. Qiu, M.E. Plesha, D.W. Meyer, Stiffness matrix integration rules for contact-friction finite elements, *Comput Methods Appl Mech Engng* 93 (1991) 385–399.
- [17] Wang C, Carter JP, Deep penetration of strip and circular footings into layered clays. Center of geotechnical research, research report No. R807, Sydney NSW 2006.