



Flexural performance of reinforced concrete beams made with recycled concrete coarse aggregate



Sindy Seara-Paz^a, Belén González-Fontebo^{b,*}, Fernando Martínez-Abella^b, Javier Eiras-López^b

^a Department of Construction Technology, University of A Coruña, E.U. Arquitectura Técnica, Campus Zapateira s/n, 15071 La Coruña, Spain

^b Department of Construction Technology, University of A Coruña, E.T.S.I. Caminos, Canales, Puertos, Campus Elviña s/n, 15071 La Coruña, Spain

ARTICLE INFO

Keywords:

Recycled concrete
Flexural performance
Deflection
Serviceability
Cracking

ABSTRACT

This work deals with the flexural performance of recycled concrete subjected to increasing loads up to failure. For this purpose, eight reinforced concrete beams were made with recycled coarse aggregates using two different water to cement ratios (0.50 and 0.65) and four replacement percentages (0%, 20%, 50% and 100%). Firstly, the basic concrete properties were determined (mechanical strengths and modulus of elasticity) and then, beam specimens were loaded up to failure using a four-point bending test at 28 days. As a result, bending moments, deflections, strains and curvatures were obtained at different load levels (cracking, service, yielding and ultimate state conditions), and also, the crack pattern.

On the basis of these results, it can be noted that service, yielding and ultimate state of recycled concrete exhibits, in general, a similar trend to that of conventional concrete. However, the cracking behaviour shows differences between recycled and conventional concrete. Finally, code-based expressions were used to calculate bending moments and deflections under flexural load, taking into account the different content of recycled coarse aggregate.

1. Introduction

In order to promote the sustainability of concrete, efforts have been made to address some of the environmental problems associated with concrete waste. In line with this, numerous researches have been conducted to analyse the structural performance of recycled concrete [1–13]. However, its use in real building and civil engineering applications requires more full scale studies, to assess the load-deformation response of recycled concrete that leads to good agreement on structural design.

Regarding flexural performance of structural recycled concrete, different investigations have been carried out [4,8,9,12]. However, the number of studies on concretes with high replacement percentages is scarce and additionally, some contradicting conclusions have been detected. While some authors [1,9,10,13] have found that recycled concrete beams show higher deflections, and cracking moments lower or similar to those of the conventional, others [6,8] have reported no significant difference between recycled and conventional concrete in terms of flexural performance.

On the basis of the literature review, it can be seen that the code-based procedures for conventional concrete can also be applied to recycled concrete predictions for flexural behaviour [2,6,9], although

some differences have been detected. In line with this, the increase in recycled coarse aggregate results in the reduction of concrete stiffness [9], which is consistent with the increased beam deflections of recycled concrete. Most authors [2,8–10] point out similar yielding and ultimate behaviour, but some [7] have found little differences in cracking behaviour, in terms of crack spacing and pattern.

In general, it can be said that recycled concretes are able to fulfill strength and serviceability requirements similarly to conventional reinforced concrete. However, in order to encourage its use as structural concrete, it is important to be able to design reinforced concrete members made with recycled coarse aggregate, using existing design methods [6]. Accordingly, recent publications [2,9] have indicated that more full-scale research should be done to establish a good agreement on its flexural performance and increase the results database for structural recycled concrete. This would lead to concrete properties, service-load and ultimate-load behaviour being predicted with the same approximation degree as conventional concrete.

Furthermore, with the aim of carrying out an accurate structural design, some concrete parameters have to be considered such as, tension stiffening, strength capacity or cracking behaviour. Tension stiffening is known as the concrete contribution after cracking and has significant importance in structural design. This parameter is required

* Corresponding author.

E-mail addresses: gumersinda.spaz@udc.es (S. Seara-Paz), bfonteboa@udc.es (B. González-Fontebo), fmartinez@udc.es (F. Martínez-Abella), jeiras@udc.es (J. Eiras-López).

to accurately design concrete structures as customary serviceability conditions occur after cracking. The strength capacity after cracking can be obtained based on the height of the compression zone of cracked concrete, which depends on the concrete deformability and reinforcement ratio. Regarding cracking behaviour, most authors have pointed out that recycled concretes show, in general, worse behaviour than conventional ones [1,9,10,13]. This will probably result in lower stiffness and therefore, lower concrete contribution after cracking when recycled coarse aggregate is used in structural members. The increased shrinkage strain of recycled concrete is related to its higher concrete deformation and lower tensile splitting strength, which result in a premature cracking and lower stiffness [14,15]. In line with this, it is expected that greater shrinkage of recycled concrete [16–21] leads to different flexural performance of recycled concrete structures.

Another important concrete feature in the design of structural concrete is the concrete-steel bond behaviour. Crack spacing and crack width depend on the interaction between concrete and steel rebars, which is also directly related to concrete stiffness after cracking. Although the lower bond strength of recycled concretes leads to the prevision of lower stiffness, this property has not been further analysed for different replacement percentages of recycled coarse aggregate. Additionally, stiffness after cracking largely depends on the compression height, which can be experimentally determined using a strain diagram of the cross section. Therefore, a sectional analysis is required to fully understand the structural behaviour of recycled concretes, especially its serviceability.

After reviewing available literature, it can be detected that there is no agreement on the effect of these features when their joint influence is analysed on a full-scale concrete structure made with recycled coarse aggregates. Hence, the aim of this work is to provide useful guidelines for a full structural serviceability and ultimate stage design, involving different replacement percentages of recycled coarse aggregates and the effect of concrete properties.

2. Objectives and methodology

The main goal of this work is to analyse the flexural performance of recycled concrete, in order to design structural concrete using recycled coarse aggregates with a similar degree of approximation as conventional concrete.

For said purpose, simply-supported reinforced concrete beams were tested using a full scale load test up to failure with displacement control. All beam specimens were gradually loaded up to collapse using a four-point bending and loading procedure. In order to analyse the flexural performance of recycled concrete beams under short term load, the moments and deflections were determined, and studied at cracking, service, yielding and ultimate state. The cracking pattern was also evaluated.

The methodology chosen to analyse the results was developed in two stages. In the first stage, the objective is to know how much the main flexural parameters (cracking moment, yielding moment, deflections, cracking...) are affected by the incorporation of recycled aggregate. Therefore, all concretes were made with the same dosage but for the coarse aggregate, which was replaced with recycled concrete coarse aggregate (by volume) at different percentages. With the different concretes the beams were made and their flexural behaviour compared after being tested up to failure.

In the second stage the objective is to analyse if it is necessary or not to adapt the flexural code proposals (adjusted for conventional concretes) to take into account the recycled aggregates used. This analysis has been made using the ratios “experimental parameter/calculated parameter”. If the ratios obtained with conventional and recycled beams are similar, code expression can be used and provide a similar approximation degree regardless the type of the concrete (recycled or conventional). If the ratios are different code expression need to be corrected.

This methodology lead to the assessment of, not only the flexural behaviour of structural concrete made with recycled coarse aggregate, but also the suitability of current code expressions to design this concrete.

Abbreviations

f_c	Compressive strength at 28 days (MPa)
f_{ct}	Tensile splitting strength at 28 days (MPa)
E_c	Modulus of elasticity at 28 days (MPa)
δ_{cr}	Cracking deflection at midspan beam (mm)
δ_{yiel}	Yielding deflection at midspan beam (mm)
δ_{ult}	Ultimate deflection at midspan beam (mm)
δ_{ser}	Service deflection at midspan beam (mm)
M	bending moment (kN m)
M_{cr}	Cracking moment at midspan beam (kN m)
M_{yiel}	Yielding moment at midspan beam (kN m)
M_{ult}	Ultimate moment at midspan beam (kN m)
M_{ser}	Service moment at midspan beam (kN m)
$M_{L/350}$	Moment related to the maximum deflection admitted by Structural Code at midspan beam (kN m)
W_{ck}	Crack width (mm)
$S_{r,max}$	Maximum crack spacing (mm)
$\varepsilon_{sm}-\varepsilon_{cm}$	Average of steel and concrete strains at tensile stress ($\mu\epsilon$)
x	Depth of the compression zone (mm)
c	Concrete cover (mm)
ϕ	Bar diameter (mm)

3. Experimental program

This investigation is part of a long research project, whose main objective was to carry out a full study of structural recycled concrete. Physical and mechanical properties, bond behaviour, shrinkage and creep have already been evaluated in previous works [7,11,22]. This research focuses on the flexural performance of reinforced concrete beams made with recycled coarse aggregate. For said purpose, reinforced beams were made from each designed concrete and loaded up to failure, to obtain deflections and strains at different load levels (pre-cracking, cracking, service, yielding and ultimate state conditions). This experimental program also encompassed basic concrete characterization, both in fresh and hardened state.

3.1. Materials and concrete mixtures

CEM I-52.5N/SR cement according to EN 197-1 and a super-plasticizer as a water reducing admixture SIKAMENT 500 HE were used.

Three different size fractions of coarse aggregate were used, two conventional aggregates from crushed limestone and one recycled aggregate from the demolition of concrete structures mainly consisting of aggregate with adhered mortar. Regarding fine aggregate, only natural sand was used, also from crushed limestone. Table 1 summarizes the basic properties of these aggregates and Fig. 1 shows their grading

Table 1
Basic properties of the aggregates used [7,11,22].

		0–4N	8–20N	4–12N	4–16R
Density (EN 1097-6)	kg/m ³	2669.4	2655.9	2610.4	2566.0
Density in oven-dry conditions (EN 1097-6)	kg/m ³	2520.3	2565.2	2468.8	2254.0
Water absorption (EN 1097-6)	%	2.2	1.3	2.2	5.4
Los Angeles Abrasion (EN 1097-2)	%	–	23.1	–	34.3
Fineness module (EN 933-1)		3.7	7.4	6.2	7.2
Fines percentage (EN 933-1)	%	11.5	0.4	1.5	0.3
Moisture content (EN 933-1)	%	0.1	0.1	0.1	2.9

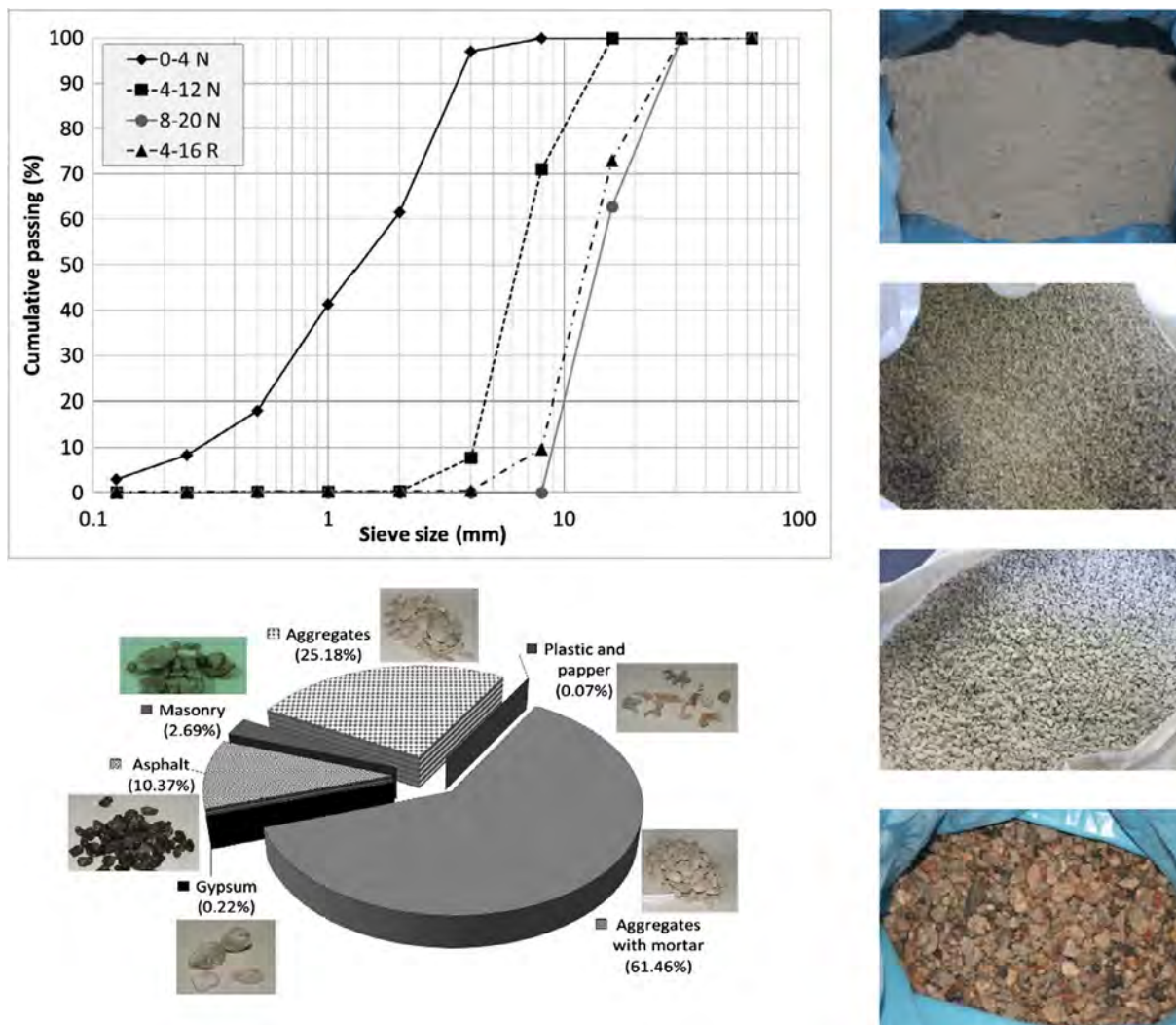

Fig. 1. Aggregate grading's and composition of recycled coarse aggregates (percentage by weight) [11,21].

curves and the composition of the recycled coarse aggregate. These results have already been presented in previous papers [7,11,22], which analyse other concrete properties as part of this broad research project on structural recycled concrete.

Using these materials, two series of concrete have been designed, one with a water to cement ratio of 0.50, and another of 0.65. The first one was selected to be used under quite aggressive environmental conditions and the 0.65 ratio corresponds to the maximum admissible by the standards in structural concrete (suitable to be used in non-aggressive environmental conditions). They are named H50 and H65, respectively. Each series consisted of four types of concretes, three of which were made using different replacement percentages of conventional coarse aggregate with recycled aggregate (20%, 50% and 100%, by volume); and the other with 0% replacement in order to obtain a baseline concrete. Finally, eight different concretes were designed, hereinafter referred to as H50-0, H50-20, H50-50, H50-100, H65-0, H65-20, H65-50 and H65-100.

It is widely known that recycled aggregate shows a high water absorption capacity due to the adhered mortar [23–25]. This feature reduces the available water in the concrete mix which influences the concrete properties, thus, a specific mixing process has to be used to avoid this effect. In this research, recycled aggregate was pre-saturated to up to 80% of its water absorption before mixing [24,25]. Concrete dosages can be seen in Table 2.

3.2. Test specimens

Eight reinforced concrete beams were made. All of which with a rectangular cross section of 30 × 20 cm (height × width) and length of 360 cm, Fig. 2.

These reinforced concrete beams were designed in accordance with structural concrete Codes [26,27] taking customary serviceability conditions into account. Therefore, the reinforcement was designed to obtain a ductile mode of failure.

Due to the environmental conditions selected to each concrete series, the concrete cover of the corresponding series of beams was different and hence, the longitudinal tensile reinforcement ratio was 0.81% and 0.76% for H65 and H50 beams, respectively. Despite the compression steel not being necessary according to code-based structural design, it was decided to include the minimum amount required to favour the casting and distribution of stirrups in concrete beams.

3.3. Test procedure and instrumentation

Flexural performance was evaluated with a four-point bending test using simply-supported reinforced concrete beams. This kind of flexural test generates a constant bending moment at the beam's midspan, where maximum strains, moments and deflections occur, and hence, this study was especially focused on load-deformation analysis at the beam's midspan.

Table 2
Mix proportions 1 m³.

		H50-0	H50-20	H50-50	H50-100	H65-0	H65-20	H65-50	H65-100
Cement	kg	380.00	380.00	380.00	380.00	275.00	275.00	275.00	275.00
Water	kg	190.00	190.00	190.00	190.00	178.75	178.75	178.75	178.75
0–4N	kg	781.43	781.43	781.43	781.43	918.49	918.49	918.49	918.49
8–20N	kg	665.44	532.35	332.72	0.00	486.19	388.95	243.10	0.00
4–12N	kg	307.93	246.34	153.97	0.00	457.65	366.12	228.83	0.00
4–16R	kg	0.00	173.07	432.68	865.36	0.00	168.84	422.10	844.20
w/c		0.5	0.5	0.5	0.5	0.65	0.65	0.65	0.65
Admixture	%	0.85	1.2	1.07	1	0.85	1.2	1.07	1

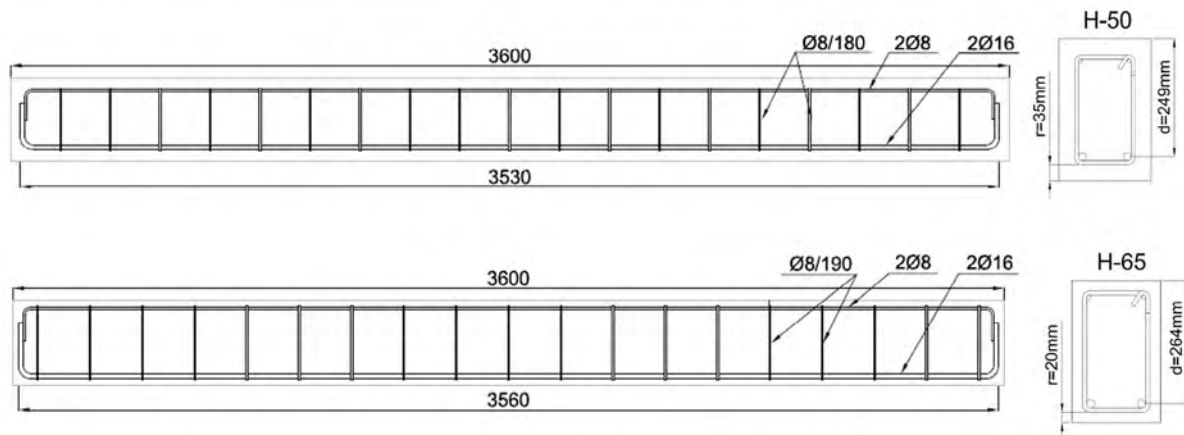

Fig. 2. Beam specimens (mm).

A metallic load frame was assembled and equipped with a servo-hydraulic actuator to apply the load to another metallic frame lying on the concrete beam at two points, and in this manner, generating a region of constant bending moment. The concrete beams were supported on a roller and a pin support resulting in a clear span of 340 cm, a flexural span of 85 cm and two symmetrical shear spans of 127.5 cm. The load was applied using a displacement control method with a rate of 1.5 mm/min for 2 min. Once this loading step finished, the load was maintain for a period of 1 min. Within this period, the cracks developed were drawn using a color-coded system. This sequence was repeated up to failure. As a result, crack pattern was obtained for each concrete (shown in Fig. 7).

The deflection was measured by a displacement transducer placed at the beam's midspan (MS). In addition, two more displacement transducers were placed symmetrically at the middle of the shear spans (SS-1 and SS-2) to complete and confirm the experimental data registered by the MS transducer. Fig. 3 shows the experimental setup of the tests.

Three cross sections within the constant flexural span of the beams were also instrumented with concrete and steel gauges in order to register the concrete and reinforcement strains. The steel gauges were placed at compression and tensile reinforcement at both sides (West and East) of the three different cross sections: CS-1 (at 35 mm to the left

from the midspan cross section), CS-2 (midspan cross section), and CS-3 (at 35 mm to the right from the midspan cross section). Regarding the concrete gauges, they were placed at midspan cross section at the same height as the compression and tensile reinforcement bar at each side of the beam. Fig. 4 shows the distribution of the gauges on the reinforced concrete beams (RC beams).

Finally, the load applied was acquired using the load cell of the servo-hydraulic actuator, and the crack pattern was visually obtained at different load levels. Load, deflections and strains were continuously monitored and recorded by a data acquisition system during the testing time.

3.4. Concrete properties

In order to characterize these concretes, basic properties of designed concretes were determined. Firstly, the fresh concrete properties were obtained by measuring the consistency using the slump-test (EN 12350-2) and the density according to standard EN 12350-6. Regarding the basic properties of hardened concrete, cylindrical specimens of 10 × 20 cm were used to determine the density and water absorption at 28 days according to EN 12390-7. As already reported by other authors [23,24,28,29], the water absorption coefficient increases and the density decreases (both in fresh and hardened state) when replacement

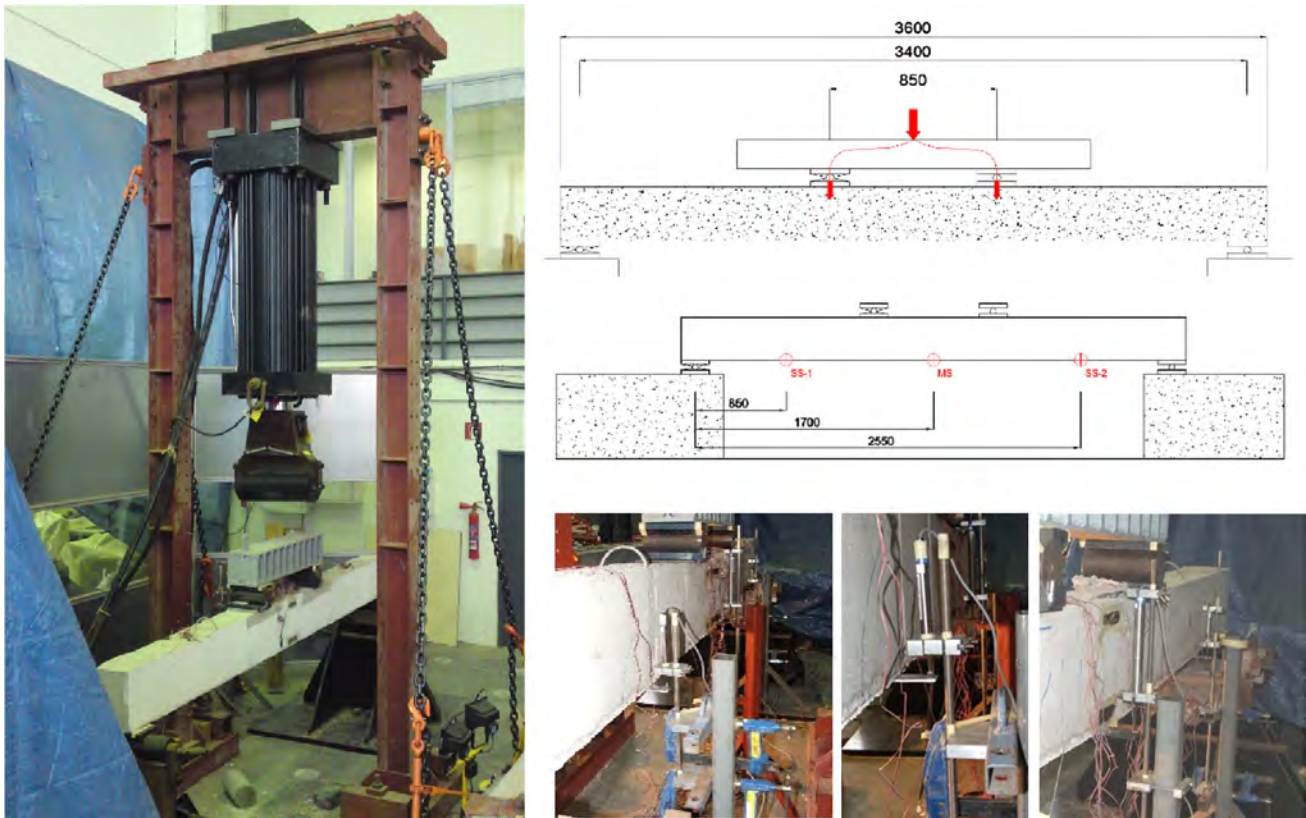

Fig. 3. Flexural test up to failure at 28 days (SS-1, SS-2 and MS: displacement transducers).

percentage increases due to the adhered mortar of the recycled coarse aggregates. The higher porosity of adhered mortar results in lower density and higher water absorption of concrete when recycled coarse aggregates are used.

Mechanical properties were also determined using cylindrical specimens of 15 × 30 cm, in order to obtain compressive strength, tensile splitting strength and modulus of elasticity according to EN 12390-3, EN 12390-6 and EN 83316, respectively. These mechanical properties were evaluated at 28 days (age of the flexural tests). As expected, compressive strength, tensile splitting strength and modulus of elasticity of recycled concretes decline when the replacement percentage increases. This effect is attributed to the presence of two different interfacial transition zones (ITZ): one between the coarse aggregates and the new cement mortar and another, between the new and the old cement mortar. This second ITZ tends to be weaker than the paste-aggregate matrix of conventional concretes and consequently, reduces the concrete strength, leading to a higher deformability of recycled concretes compared with conventional concretes [28,30–34]. The strength of these ITZs also depends on the water-cement ratio (w/c). Concretes

with low water to cement ratio show high influence of using recycled aggregates due to the concrete strength is governed by the effect of old ITZs. Consequently, the content of recycled aggregates influences strength of H50 recycled concretes to a greater extent than those of H65 concretes [33].

Table 3 summarizes these concrete properties, which have been more thoroughly discussed in previous papers [11,21]. This table also includes the coefficients of variation of the mechanical properties. These coefficients show a statistical behaviour of recycled concretes similar to that of conventional concrete.

4. Results and discussion

4.1. Results

The testing beams were designed for ductile performance, so that the steel reinforcement yields before concrete failure. The flexural cracks occurred in the region of maximum moment appearing on the bottom of the beam's middle section. As the loading increased, these

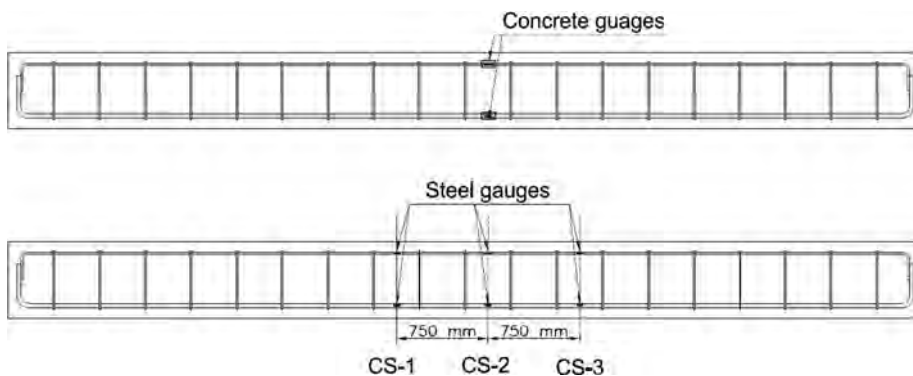

Fig. 4. Gauges distribution at reinforced beams.

Table 3
Concrete properties [11,21]

		H50-0	H50-20	H50-50	H50-100
Slump values	cm	16	17	16	19
Density of fresh concrete	kg/m ³	2370.18	2362.26	2361.96	2284.84
Density of hardened concrete	kg/m ³	2324.05	2303.28	2278.18	2227.06
Absorption of concrete	%	1.38	1.81	1.75	2.60
f _c	MPa	60.7	53.5	51.8	42.9
Coefficient of variation	%	3.9	3.6	4.1	4.3
f _{ct}	MPa	4.3	3.1	2.4	2.3
Coefficient of variation	%	1.7	4.8	2.1	6.7
E _c	MPa	36,300	32,900	31,600	25,900
Coefficient of variation	%	1.3	2.3	0.7	2.3

		H65-0	H65-20	H65-50	H65-100
Slump values	cm	6	10	12	16
Density of fresh concrete	kg/m ³	2365.84	2325.82	2309.02	2281.93
Density of hardened concrete	kg/m ³	2307.93	2257.30	2256.47	2215.25
Absorption of concrete	%	2.63	2.95	2.83	3.8
f _c	MPa	46.9	46.7	42.2	32.4
Coefficient of variation	%	1.32	1.11	2.13	1.08
f _{ct}	MPa	4.0	3.8	3.4	2.3
Coefficient of variation	%	10.8	3.9	0.3	4.6
E _c	MPa	35,200	32,500	27,400	24,100
Coefficient of variation	%	3.0	4.9	0.3	0.9

flexural cracks grew vertically towards the compression zone and then, some inclined flexure-shear cracks appeared. As the strain of the reinforcement bar reached the yielding value, the flexural crack in the middle of the span widened and the deflection began to rapidly increase. Finally, all concrete beams failed in flexure due to the yielding of the longitudinal steel and the subsequent concrete crushing in the compression zone, Fig. 5.

Fig. 6 shows the diagrams of the moment–midspan deflection of the H50 and H65 concrete beams. In general, these exhibit a similar trend for recycled and conventional concretes. The bending moments were calculated using the load registered at the midspan of the beam, where the maximum value occurs. Additionally, deflections at the middle of the shear spans (SS) are included in Fig. 6. As expected, shear span deflections show a similar trend to that measured at the beam midspan. These results were obtained as the average of deflections registered by two displacement transducers placed symmetrically at the middle of the shear spans (SS-1 and SS-2) at each concrete beam.

In order to further study the flexural performance of recycled concretes under short term load compared to conventional concretes with the same dosage, some singular values of bending moments have been determined, Table 4. In this manner, cracking (M_{cr}), yielding (M_{yel}) and ultimate (M_{ult}) moments have been obtained and also the moment value related to the maximum deflection limited by structural Codes [26,27,35], that is the maximum deflection under serviceability conditions, L/350 (being L = 3400 mm), named as M_{L/350}. In this work, M_{L/350} corresponds to a deflection of 9.71 mm at the midspan of the

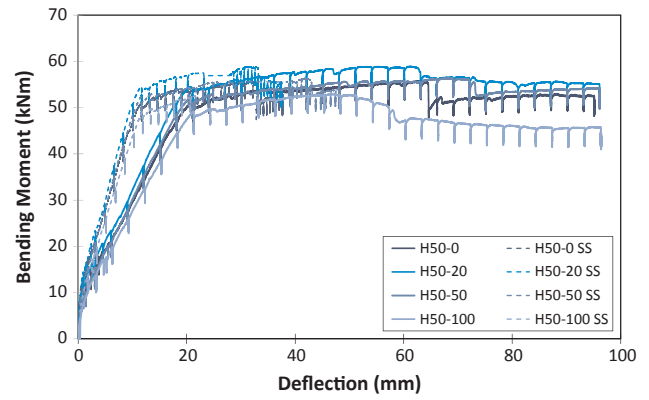

a) H50 concretes

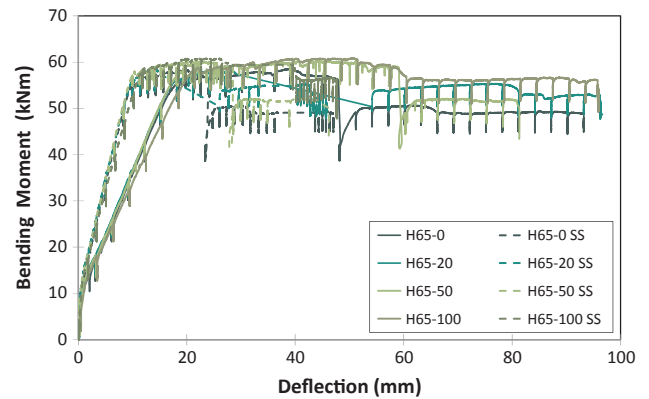

b) H65 concretes

Fig. 6. Moment – deflection at mid-span of concrete beam (a) H50 concretes, (b) H65 concretes moment and deflection analysis.

concrete beam. Then, the bending moment related to this experimental deflection was obtained from the curve moment – deflection.

Accordingly, the cracking (δ_{cr}), yielding (δ_{yel}) and ultimate (δ_{ult}) deflections were also determined. With the aim of analyzing the deflection at the same bending moment, the service moment (M_{ser}) was included in this analysis. This was calculated as that obtained with customary service loads [26,27,35] and, in these concrete beams, corresponds to a moment of 30.22 kNm. This value was used to determine the service deflection (δ_{ser}). All of these midspan deflections are listed in Table 5.

On the basis of these results, it can be noted that **cracking moments** are significantly reduced as the content of recycled aggregate increases. This reduction is consistent with the lower tensile splitting strength of recycled concretes, which leads to an earlier cracking than with conventional concretes. In terms of cracking moments, drops of

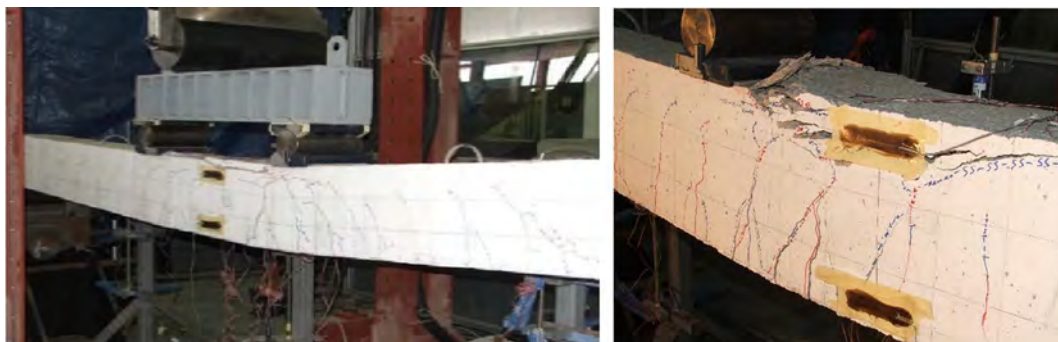

Fig. 5. Concrete crushing at failure.

Table 4
Bending moments experimentally obtained (Exp.) and calculated according to code-based expressions (Calc.), and ratios with cracking moment.

			H50-0	H50-20	H50-50	H50-100	H65-0	H65-20	H65-50	H65-100
M_{cr}	kNm	Exp.	13.04	11.62	7.10	7.00	11.32	10.13	9.02	8.33
		Calc.	15.52	13.51	12.46	9.59	13.01	12.99	12.19	10.16
$M_{L/350}$	kNm	Exp.	28.87	31.4	29.37	26.96	35.15	36.3	35.87	32.17
M_{yiel}	kNm	Exp.	50.94	54.49	52.25	49.19	56	55.52	57.95	58.79
		Calc.	49.46	47.80	45.83	44.72	49.12	52.88	52.68	47.41
M_{ult}	kNm	Exp.	55.71	58.89	56.32	52.93	58.51	58.27	60.21	60.83
		Calc.	48.44	52.58	52.64	51.89	55.20	55.50	54.74	53.83
M_{cr}/M_{yiel}	–		0.20	0.18	0.16	0.14	0.26	0.21	0.14	0.14
M_{cr}/M_{ult}	–		0.19	0.17	0.15	0.14	0.23	0.20	0.13	0.13
M_{yiel}/M_{ult}	–		0.91	0.93	0.93	0.93	0.96	0.95	0.96	0.97

11%, 45% and 46% have been detected for H50-20, H50-50 and H50-100, respectively. These reductions are 10%, 20% and 26%, when H65 concretes are analysed.

Regarding **bending moment** for maximum deflection under **serviceability** conditions ($M_{L/350}$), it can be seen that this value decreases, although very slightly, when recycled concretes with high replacement percentages are used, showing reductions of 7% and 9% for H50-100 and H65-100, respectively. Accordingly, **service deflection** (δ_{ser}) was analysed. It is widely known that recycled concrete shows higher deformations than conventional concrete due to its lower modulus of elasticity. This effect has already been detected in previous works [11,21,22,36]. Therefore, it was expected that the higher deformability of recycled concrete results in higher deflections. However, only beams made with recycled concrete with 100% replacement percentage showed slightly higher deflections than those of conventional concrete (10% of increment) [9,10].

To further understand this tendency, concrete properties and parameters that influence beam deflections have to be considered. As is well-known, concrete deflections can be calculated by integrating the curvatures, which largely depend on the reinforcement ratio, concrete cover and modulus of elasticity of concrete and reinforcement steel. Taking into account that recycled concrete beams have the same reinforcement steel (reinforcement ratio and modulus of elasticity) and also, the same concrete cover as those of conventional concrete, only the modulus of elasticity of concrete can lead to differences in concrete deflections. However, the use of high amounts of reinforcement steel leads to scarce increments in deflection at serviceability, despite the lower modulus of elasticity of recycled concrete. In agreement with other authors [8], the analysis of deflections in a concrete structure cannot be directly related to material properties in a straightforward manner (modulus of elasticity).

As a result, it can be stated that, the content of recycled coarse aggregate has a slight influence on service deflections and bending moments under serviceability conditions. In fact, the ductile design of concrete beams (with a suitable tensile reinforcement steel ratio) results in limited concrete contribution at failure. In addition, the use of the compression steel increases the ultimate strength of the beams and also minimizes the concrete contribution at flexural failure. Both these facts lead to the conclusion that recycled aggregate content hardly affects **yielding and ultimate moments**. Again accordingly, **yielding and ultimate deflections** showed no significant differences between

recycled and conventional concretes.

To confirm these results, the ductility ratio has been calculated as the relationship between yielding and ultimate deflection [6,8], Table 5. It can be seen that both recycled and conventional concretes show a similar ductile ratio.

4.2. Crack pattern

In order to assess the cracking behaviour of recycled concrete compared to conventional one of same dosage, the relationships between cracking and yielding moments (M_{cr}/M_{yiel}), and cracking and ultimate moments (M_{cr}/M_{ult}) have been calculated, Table 4. These ratios confirm the **premature cracking** of recycled concretes compared with that of the conventional. It can be noted that the cracking moment of recycled concrete made with 100% recycled coarse aggregate occurs at 13–14% of its ultimate moment, while conventional concrete has to develop 19–23% of its M_{ult} to reach the cracking moment. These differences are more significant with high replacement percentages of recycled coarse aggregate (50 and 100%) and are consistent with the lower tensile splitting strength of recycled concrete.

In order to further develop the crack pattern, the **crack development** was drawn during the flexural test at different load levels. As a result, a crack pattern was obtained for recycled and conventional concretes, Fig. 7. Two different loading levels have been analysed, after cracking at 50% of the ultimate load and at ultimate load (failure in flexure). Both recycled and conventional concretes show similar crack development. All concrete beams began with the appearance of flexural cracks after cracking at the bottom of the middle section, which grew vertically. Additionally flexural cracks developed between the midspan section and the support zone. Upon further increasing the load, some inclined flexure-shear cracks emerged, however, no visible cracks appeared in the region of the supports. Finally, the flexural crack in the middle of the span widened and the beams failed due to concrete crushing in the compression zone (Fig. 5).

In addition, at failure, beams show some horizontal splitting cracks along the tensile reinforcement, especially those of recycled concrete with high replacement percentages (Fig. 7). These horizontal cracks are attributed to the lower bond stress between the recycled concrete and reinforcement bars compared with that of the conventional concrete. Different authors have already stated that bond strength of recycled concretes decreases as the replacement percentage increases

Table 5
Deflections at midspan experimentally obtained and calculated according to code-based expressions and ductility ratio.

			H50-0	H50-20	H50-50	H50-100	H65-0	H65-20	H65-50	H65-100
δ_{cr}	mm		0.73	0.99	0.58	0.82	0.99	0.65	0.66	1.19
δ_{ser}	mm	Exp.	10.27	9.31	10.05	11.17	8.05	7.67	7.91	8.94
		Calc.	9.51	10.46	11.17	12.69	9.25	9.24	9.53	10.16
δ_{yiel}	mm		20.83	20.75	20.66	21.29	18.80	17.48	18.98	22.41
δ_{ult}	mm		95.16	96.14	98.29	96.40	93.31	96.65	81.36	96.41
$\delta_{yiel}/\delta_{ult}$	%		21.89	21.58	21.02	22.09	20.15	18.09	23.33	23.24

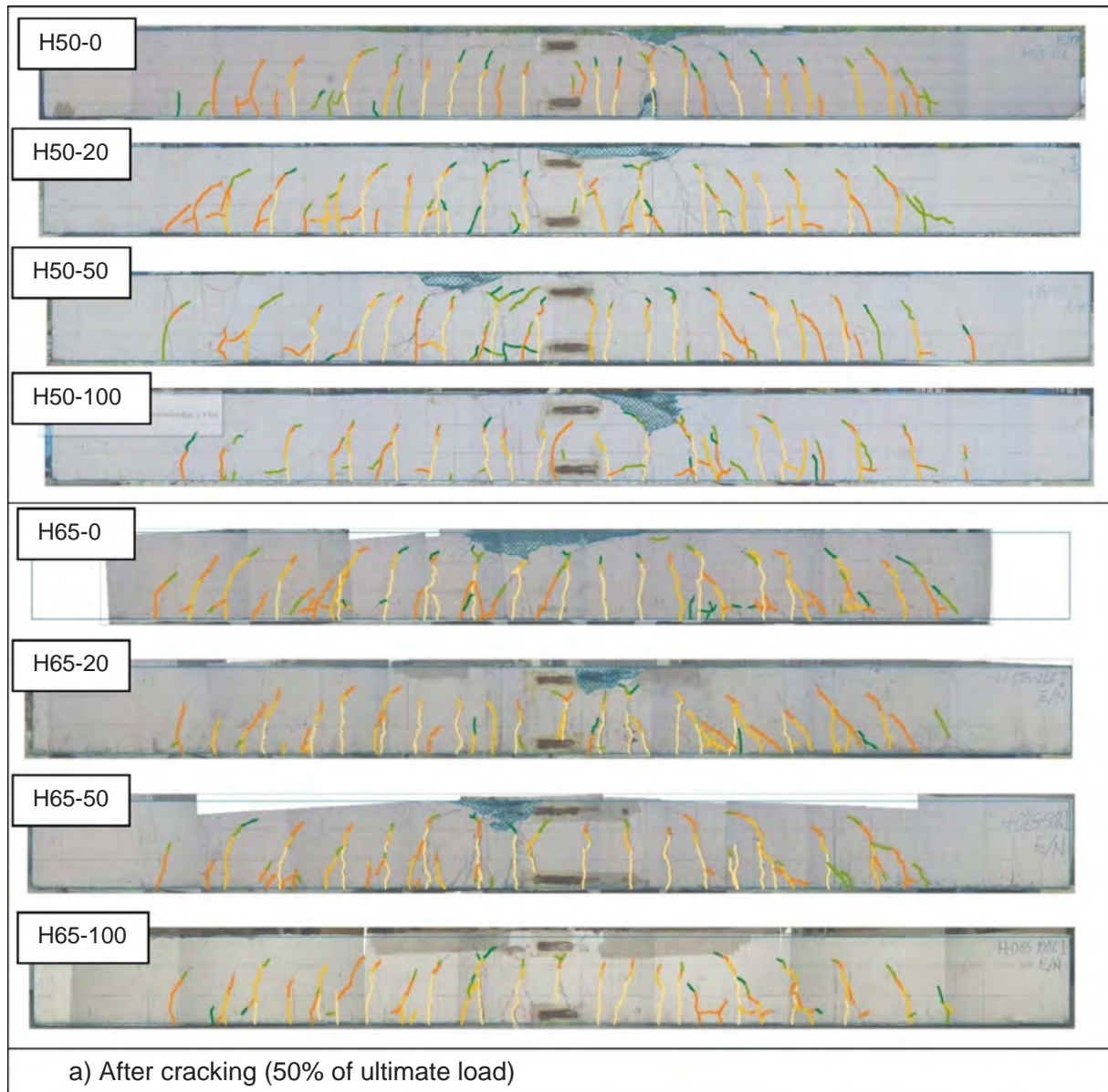

Fig. 7. Crack distribution at the beam tests (a) after cracking (50% of ultimate load) and (b) at failure.

[11,37,38]. Therefore, the different bond behaviour of recycled concretes influences crack development at failure.

In terms of **crack distribution**, it can be stated that the use of recycled coarse aggregate did not cause an observable change in **crack spacing**. The higher strains of recycled concrete due to their lower modulus of elasticity, and lower tensile splitting strength would make flexural cracks form closer to each other and therefore, would reduce the crack spacing. However, the lower *bond strength* of recycled concrete counteracts this effect [11] due to less steel restraint. As a result, no significant differences have been found between conventional and recycled concrete crack spacing [10,39]. This can be seen in Table 6 that shows the experimentally obtained crack spacing ($S_{r,max}$) from Fig. 7. Comparing, however, the crack spacing obtained in the H50 series with that obtained in the H65 series, it can be seen that, due to the concrete cover (lower in H65 series), the crack spacing is lower in this series than in the H50 one.

Another important feature required to assess the cracking behaviour of concrete is the **crack width**, which is directly related to the crack spacing and the strain at the tensile reinforcement zone. As aforementioned, recycled concrete shows the same crack spacing as conventional

concrete, so according to Eurocode-2, Eq. (1) [27], concrete and steel strains can be used to obtain crack width.

$$w_{ck} = S_{r,max} (\epsilon_{sm} - \epsilon_{cm}) \quad (1)$$

Crack widths at 50% of ultimate bending moment were achieved (Table 6) using the maximum crack spacing ($S_{r,max}$) obtained from the crack pattern, the concrete strain (ϵ_{cm}) registered by the gauge placed at midspan and the mean strain in the reinforcement (ϵ_{sm}) measured by six different gauges located at both sides (W-West and E-East) of three different beam sections: CS-1, CS-2 and CS-3 (defined in Fig. 4). The crack width of beams made up with concretes H65-50 and H65-100 could not be obtained due to the failure of concrete gauges at this zone after cracking. On the basis of these results, it can be confirmed that recycled concrete tends to develop a greater crack width than conventional concrete. Again in this case, due to the concrete cover, H65 series present lower crack widths than H50 one.

4.3. Cross section analysis

The cross section analysis attempts to determine the differences

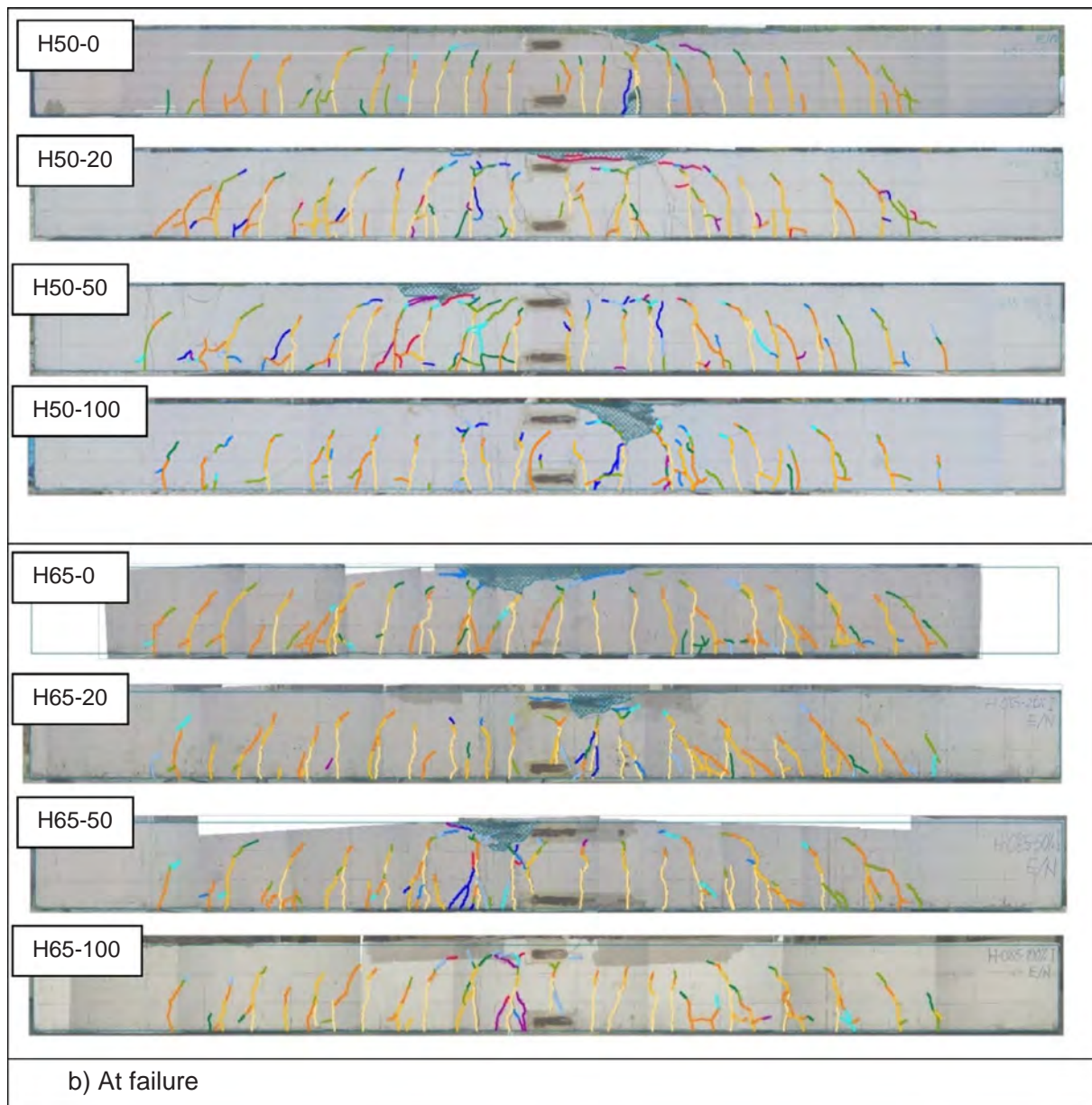

Fig. 7. (continued)

between recycled and conventional concretes with the same dosage in terms of curvature, stiffness and depth of the compression zone.

Firstly, the moment – curvature diagrams were obtained, Fig. 8. The experimental curvatures were calculated using the strains registered by the steel gauges placed at midspan cross section and assuming the Bernoulli-Euler hypothesis, which admits a linear strain distribution over the cross section.

All concrete beams exhibit a **moment – curvature diagram** with a long branch after yielding, which confirms the ductile behaviour of

them all, as can be seen in detail enlarged of Fig. 8. These diagrams were calculated using the steel gauges placed at three different cross sections within the constant bending span of RC beams (gauges distribution detailed in Fig. 4). All of them present a similar trend and confirm that recycled concrete beams develop higher curvatures than the conventional ones.

At service moment, H50-100 and H65-100 beams showed, in comparison with those of the conventional ones, increases in curvature of 28% and 14%, respectively.

Table 6
Moment (M) at 50% of ultimate bending moment, maximum cracking spacing ($S_{r,max}$) and crack width (W_{ck}).

		H50-0	H50-20	H50-50	H50-100	H65-0	H65-20	H65-50	H65-100
M	kNm	27.4	29.4	28.2	26.5	28.1	28.0	28.8	29.2
$S_{r,max}$	mm	Exp. 188.0	187.0	184.0	183.0	153.0	153.0	152.0	152.0
	mm	Calc. 226.2	225.1	224.1	221.5	173.5	172.9	171.5	168.5
W_{ck}	mm	Exp. 0.22	0.25	0.25	0.27	0.16	0.19	–	–
	mm	Calc. 0.20	0.22	0.21	0.20	0.15	0.15	0.15	0.15

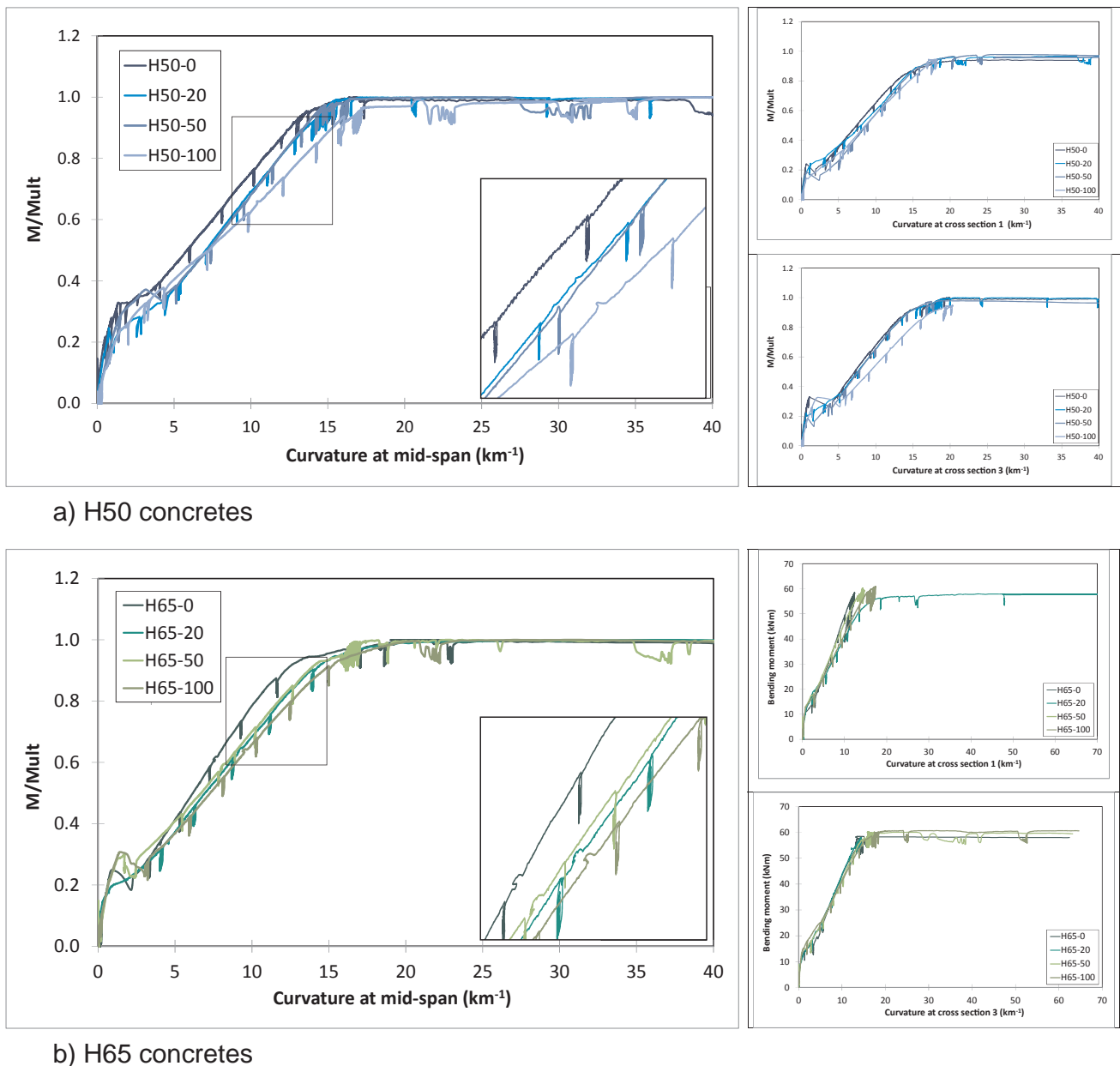

Fig. 8. M/M_{ult} – curvature (a) H50 concretes, (b) H65 concretes.

The moment-curvature diagrams were also obtained at other two cross sections within the constant bending span of beam using the steel gauges placed at those points (detailed in Fig. 4). These results present a similar trend to those obtained at the midspan section and lead to the conclusion that recycled concrete As aforementioned, beam deflections hardly showed any differences between recycled and conventional concretes due to the scarce influence of the modulus of elasticity (material properties) in structural properties when structural members are designed to present a ductile behaviour. However, cross section curvatures are obtained using the experimental strains developed at beam midspan which depend on material properties (modulus of elasticity). Therefore, concrete properties influence cross-section curvatures.

Taking into account that customary service conditions occur after cracking, the performance of cracked cross-section must be analysed in order to study the serviceability state of concrete structures. This analysis is carried out at the same load level, 50% of ultimate load. Accordingly, the strain diagrams of the cross section after cracking were obtained by using the experimental strains registered at the

compression and tensile reinforcement zone, Fig. 9. These diagrams were drawn based on the assumption that plane sections remain plane after loading, according to the Bernoulli-Euler theory for bending beams. On the basis of the results, it can be seen that strain, both of concrete and steel, increases as the replacement percentage rises. This is attributed to the lower stiffness of recycled concrete and also its premature cracking. Both effects lead to higher strains and consequently, greater curvatures, especially in concretes with high replacement percentages.

Fig. 9 also exhibits the **depth of compression zone (x)** of the cross section and it can be seen that recycled concrete shows a similar value to that of conventional concrete. Only beams made up with concretes H50-100 and H65-100 present a compression zone depth slightly higher than that of conventional concrete.

This difference is attributed to the lower modulus of elasticity of recycled concrete, especially noticeable with high replacement percentages (100%), that leads to greater deformations at the compression zone of the beam, and consequently, to an increase in depth of the

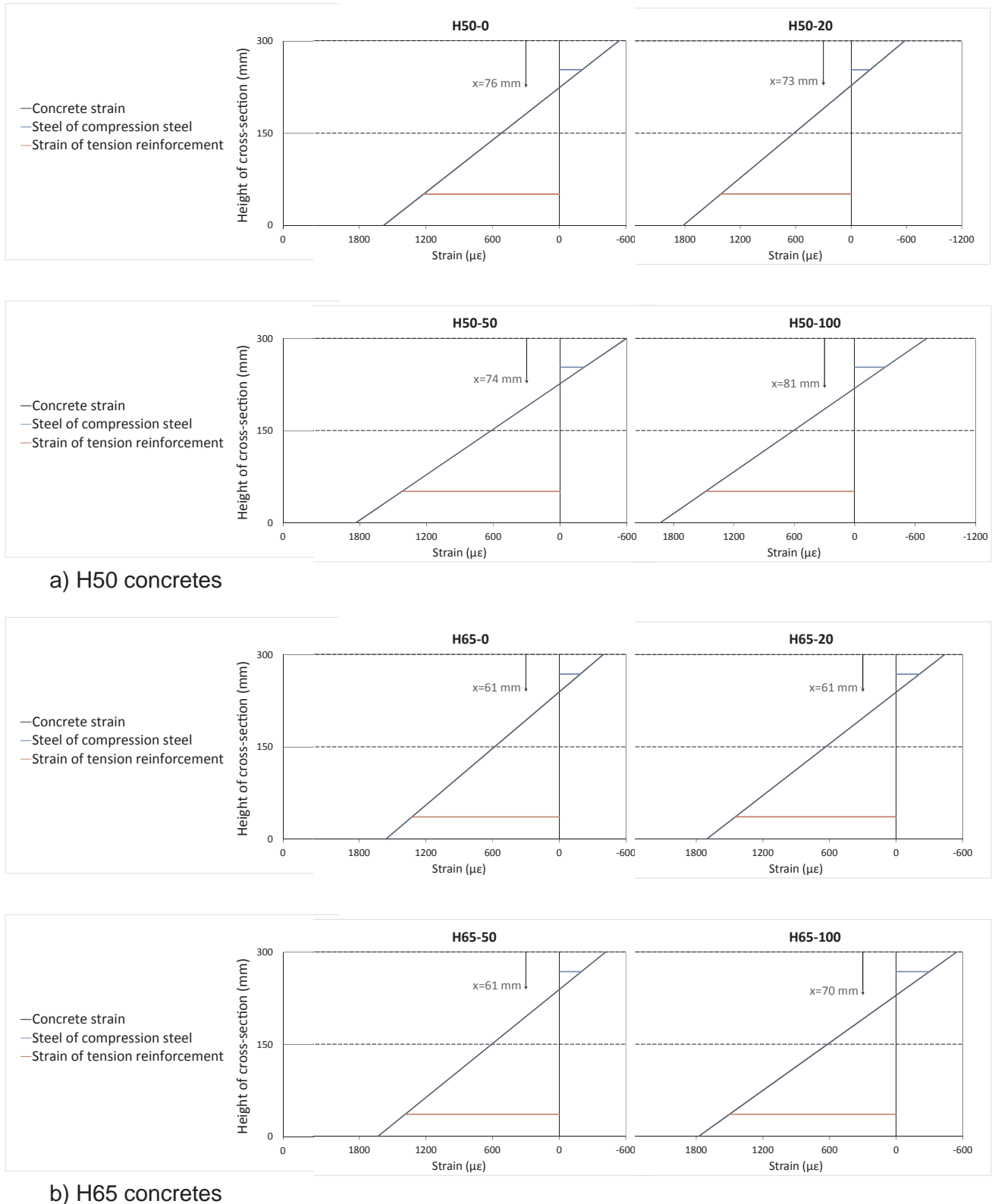

Fig. 9. Strain diagram of cross section at beam mid-span after cracking (50% of ultimate load), (a) H50 concretes and (b) H65 concretes.

compression zone.

5. Code predictions

In order to assess the approximation degree of code-based expressions [27] for designing recycled concretes, flexural behaviour, bending

moments, deflections, crack spacing and crack width have been calculated and compared with the experimental results.

These expressions require the mechanical properties, modulus of elasticity and tensile splitting strength of each concrete in order to calculate moments, deflections and cracking parameters. With the aim of considering the effect of recycled aggregate, concrete properties can

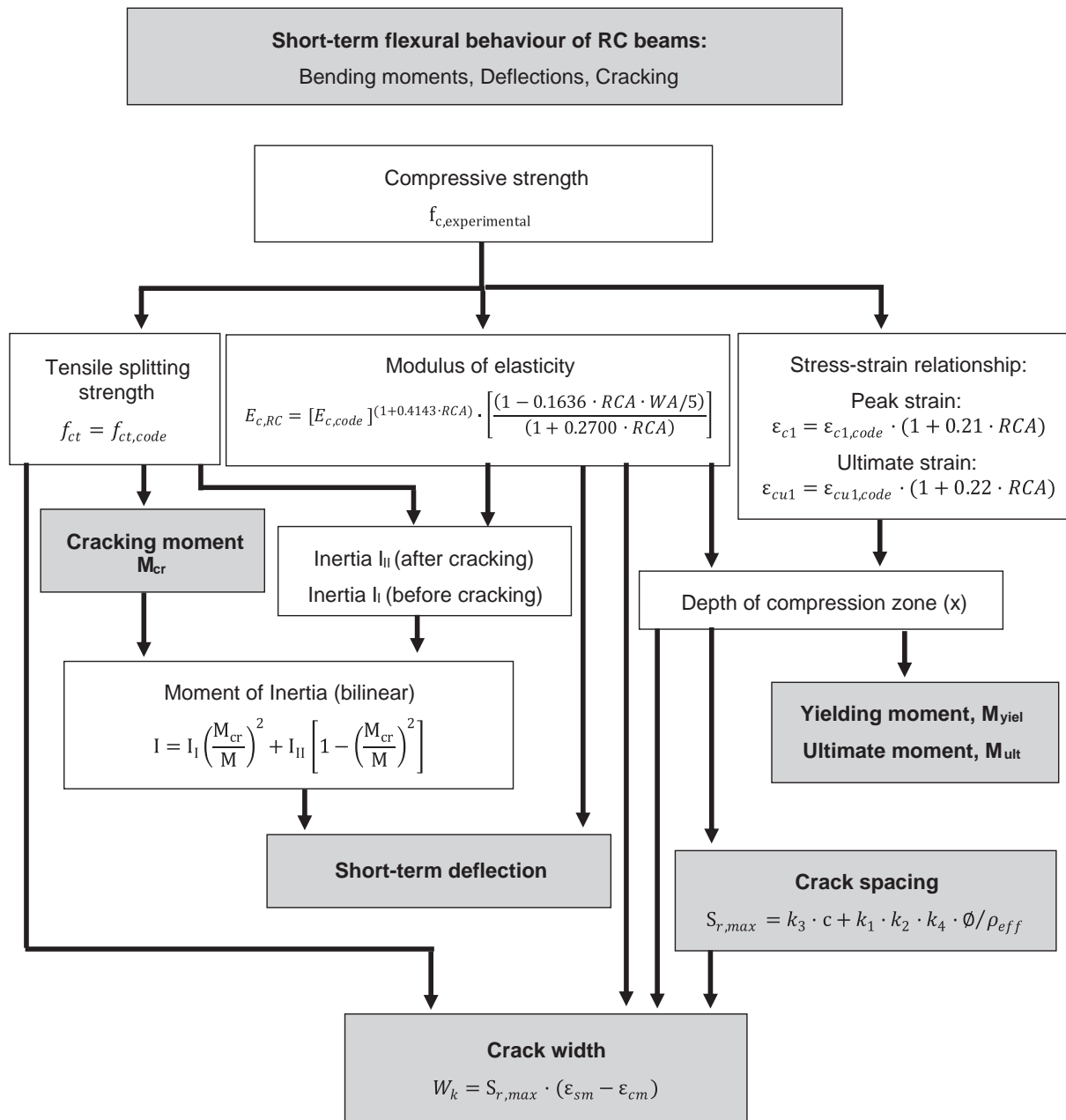

Fig. 10. Procedure to calculate flexural parameters of recycled aggregate concrete [22,27,36].

be calculated using the expressions suggested in previous works involving compressive strength at 28 days, water absorption, content of recycled coarse aggregates and mixing procedure [22,36]. Fig. 10 shows a flow chart with the procedure and models assumed to determine the calculated value of all parameters analysed in this flexural study in terms of deflection and bending moments.

Firstly, bending moments have been calculated and compared with those experimentally obtained at cracking, yielding and ultimate state, Table 4. As a result, “experimental moment/calculated moment” ratios have been calculated and listed in Table 7. On the basis of these results, it can be noted that recycled concrete shows ratios similar to those obtained with conventional concrete. This means it is not necessary to include any corrections when calculating bending moments according to the code expressions.

Regarding deflections, the value related to service moment, named as service deflection, has also been predicted and compared with that experimentally measured, Table 5. Again, the code-based expressions

provide “experimental service deflection/calculated service deflection” ratios of recycled concretes similar to those of the conventional, Table 7. In line with the prediction of bending moments, the service deflections can be calculated, with similar approximation degree to that of the conventional, using the current code expressions and the mechanical properties of each concrete.

Finally, crack spacing and crack width were calculated according to Eq. (1) [27], Table 6. Then, the “experimental value/calculated value” ratios were obtained, Table 7, to assess the approximation degree of code-expressions regarding the crack pattern of recycled concrete. The procedure to calculate both parameters can be seen in Fig. 10.

As can be seen in Fig. 10, some coefficients (k_1 , k_2 , k_3 and k_4) are required to calculate crack spacing according to Eurocode [27]. The first one (k_1) takes into account the bond properties and in this case, it was 0.8 due to the use of high bond bars. The coefficient k_2 is related to the distribution of strain and in this research it was 0.5 due to bending conditions. Regarding k_3 and k_4 , each country defines these coefficients

Table 7

Ratios “experimental result/calculated value” of moments, deflections, crack spacing and crack width at midspan of concrete beams.

	H50-0	H50-20	H50-50	H50-100	H65-0	H65-20	H65-50	H65-100
M_{cr}	0.84	0.86	0.57	0.73	0.87	0.78	0.74	0.82
M_{yiel}	1.03	1.14	1.14	1.10	1.14	1.05	1.10	1.24
M_{ult}	1.15	1.12	1.07	1.02	1.06	1.05	1.10	1.13
δ_{ser}	1.08	0.89	0.90	0.88	0.87	0.83	0.83	0.88
$S_{r,max}$	1.20	1.20	1.22	1.21	1.13	1.13	1.13	1.11
w_{ck}	0.92	0.88	0.83	0.72	0.92	0.79	–	–

in an annex of the national code for structural concrete. In Spain, the recommended values are 3.4 for k_3 and 0.425 for k_4 . Additionally, concrete cover, geometry of cross section, longitudinal reinforcement area and modulus of elasticity are also necessary. Regarding crack width, crack spacing and concrete and steel strains are used.

On the basis of these results, it can be stated that the crack spacing of recycled concrete can be calculated according to code-based expressions with a good approximation degree in comparison to that of conventional concrete. Otherwise, crack width shows lower ratios in recycled concrete than in conventional one. It can be seen that the “experimental crack width/calculated crack width” ratio decreases as the replacement percentage increases. Therefore, in this case, the code-based expressions should be corrected to provide a similar approximation degree to that of conventional concrete. However, the experimental data for crack width available in this research is not sufficient to establish a correction proposal, so, further research is required, especially in terms of bond influence. As some authors [37,40,41] point out a detrimental bond behaviour of recycled concretes compared to that of the conventional one, it would be interesting to determine its influence on those coefficients that largely depend on bond properties according to code expressions.

6. Conclusions

In this work, the flexural performance of recycled concretes has been determined. On the basis of these results the following conclusions can be drawn:

- The **cracking moment** decreases as the replacement percentage increases. This reduction is consistent with the lower tensile splitting strength of recycled concretes, which leads to a greater and earlier cracking than with conventional concrete.
- At **serviceability, bending moments and deflections** are slightly affected by the content of recycled coarse aggregate due to the low influence of material properties on structural response when structural members are designed to present a ductile behaviour.
- The ductile design of steel reinforcement leads to **yielding and ultimate** behaviour of recycled concretes similar to that of conventional concrete, even when high replacement percentages are used. Therefore, the decrease in cracking moment and the invariability of yielding and maximum moments confirms early cracking development in recycled concretes.
- The **crack pattern** shows, in general, a similar behaviour in both recycled and conventional concretes. In terms of **crack spacing**, the lower modulus of elasticity and tensile splitting strength of recycled concrete make the flexural cracks closer together and therefore, reduce the crack spacing. However, the lower bond strength of recycled concretes counteracts this effect. As a result, recycled concrete shows similar crack spacing to that of conventional concrete. Consequently, this similar crack spacing and the higher strains of concrete and steel reinforcement result in greater **crack width** in recycled concrete compared with conventional concrete.
- All reinforced concrete beams **failed in flexure** due to the yielding of the longitudinal steel and the subsequent crushing of the concrete in the compression zone. However, little horizontal cracks, branched

at the tensile reinforcement zone, have been detected in recycled concretes. This is attributed to the higher strain and the lesser bond stress of recycled concrete that influences the failure mode resulting in a slightly different crack pattern at failure.

- Recycled concrete beams develop higher strains, both in concrete and steel reinforcement, and consequently **greater curvatures** than those of conventional concrete. This effect is attributed to the lower concrete **stiffness** of the cracked cross section and its premature cracking, this being especially significant in concretes with high replacement percentages.
- The “experimental value/calculated value” **ratio** of recycled concretes are similar to those of the conventional, in terms of bending moments, short-term deflections and crack spacing. Thus, code-based equations can be used to calculate these parameters, taking into account the compressive strength at 28 days, the replacement percentage of recycled coarse aggregates and the expressions proposed in previous works [22,36]. However, the crack width requires corrections in order to be calculated with the same approximation degree as with conventional concrete.

In conclusion, according to this study, the flexural performance of recycled concrete can be predicted employing code-based proposals using the experimental compressive strength and the previously proposed expressions modified [22,36] to include the effect of using recycled coarse aggregates.

However, more works regarding structural behaviour using full scale tests are needed to develop a wide database that allows researchers to state the design procedure of recycled concrete beams with the same reliability as conventional ones and to develop statistical analysis to ensure this behaviour. This work is a first stage to get this ambitious objective.

Acknowledgments

The study is part of the projects entitled:

- “CLEAM: Clean, efficient and nice construction along its life cycle” funded by the Centre for the Technology and Industrial Development (CDTI) and led by the Group of Economical Interest CLEAM-CENIT, AIE comprising by the country’s largest construction companies (Acciona, Dragados, Ferrovial, FCC, Isolux Corsán, OHL and Sacyr) and some PYME (Informática 68, Quilosa and Martínez Segovia y asociados).
- HORREO “Robust self-compacting recycled concretes: rheology in fresh state and mechanical properties (Ref: BIA2014-58063-R)” funded by MINECO.

References

- [1] Ajdukiewicz AB, Kliszczewicz AT. Comparative tests of beams and columns made of recycled aggregate concrete and natural aggregate concrete. *J Adv Concr Technol* 2007;5:259–73. <http://dx.doi.org/10.3151/jact.5.259>.
- [2] Arezoumandi M, Smith A, Volz JS, Khayat KH. An experimental study on flexural strength of reinforced concrete beams with 100% recycled concrete aggregate. *Eng Struct* 2015;88:154–62. <http://dx.doi.org/10.1016/j.engstruct.2015.01.043>.
- [3] Choi W-C, Yun H-D. Long-term deflection and flexural behavior of reinforced

- concrete beams with recycled aggregate. *Mater Des* 2013;51:742–50. <http://dx.doi.org/10.1016/j.matdes.2013.04.044>.
- [4] Choi W-C, Yun H-D, Kim S-W. Flexural performance of reinforced recycled aggregate concrete beams. *Mag Concr Res* 2012;64:837–48. <http://dx.doi.org/10.1680/mac.11.00018>.
- [5] Etxeberria M, Marí AR, Vázquez E. Recycled aggregate concrete as structural material. *Mater Struct* 2007;40:529–41. <http://dx.doi.org/10.1617/s11527-006-9161-5>.
- [6] Fathifazl G, Razaqpur AG, Isgor OB, Abbas A, Fournier B, Foo S. Flexural performance of steel-reinforced recycled concrete beams. *ACI Struct J* 2009;106:858–67.
- [7] González-Fontebo B, Martínez-Abella F, Herrador MF, Seara-Paz S. Structural recycled concrete: behaviour under low loading rate. *Constr Build Mater* 2012;28:111–6. <http://dx.doi.org/10.1016/j.conbuildmat.2011.08.010>.
- [8] Ignjatović IS, Marinković SB, Mišković ZM, Savić AR. Flexural behavior of reinforced recycled aggregate concrete beams under short-term loading. *Mater Struct* 2012;1045–59. <http://dx.doi.org/10.1617/s11527-012-9952-9>.
- [9] Knaack AM, Kurama YC. Behavior of reinforced concrete beams with recycled concrete coarse aggregates. *J Struct Eng* 2015;141:B4014009. [http://dx.doi.org/10.1061/\(ASCE\)ST.1943-541X.0001118](http://dx.doi.org/10.1061/(ASCE)ST.1943-541X.0001118).
- [10] Sato R, Maruyama I, Sogabe T, Sogo M. Flexural behavior of reinforced recycled concrete beams. *J Adv Concr Technol* 2007;5:43–61. <http://dx.doi.org/10.3151/jact.5.43>.
- [11] Seara-Paz S, González-Fontebo B, Eiras-López J, Herrador MF. Bond behavior between steel reinforcement and recycled concrete. *Mater Struct* 2014;47:323–34. <http://dx.doi.org/10.1617/s11527-013-0063-z>.
- [12] Van Gysel A, Andries J. Study of the flexural behaviour of reinforced recycled aggregate concrete beams. *fib Symp. 2012 Concr. Struct. Sustain. Community – Proc.* 2012;2012:583–6.
- [13] Kang TH-K, Kim W, Kwak Y-K, Hong S-G. Flexural testing of reinforced concrete beams with recycled concrete aggregates. *ACI Struct J* 2014;111:607–16. <http://dx.doi.org/10.14359/5168662>.
- [14] Scalón A, Bischoff PH. Shrinkage restraint and loading history effects on deflections of flexural members. *ACI Struct J* 2008;105:498–506.
- [15] Kakiuskas G, Gribniak V, Bacinskas D, Vainiunas P. Shrinkage influence on tension stiffening in concrete members. *Eng Struct* 2009;31:1305–12. <http://dx.doi.org/10.1016/j.engstruct.2008.10.007>.
- [16] Silva RV, de Brito J, Dhir RK. Prediction of the shrinkage behavior of recycled aggregate concrete: a review. *Constr Build Mater* 2015;77:327–39. <http://dx.doi.org/10.1016/j.conbuildmat.2014.12.102>.
- [17] Tam VWY, Kotrayothar D, Xiao J. Long-term deformation behaviour of recycled aggregate concrete. *Constr Build Mater* 2015;100:262–72. <http://dx.doi.org/10.1016/j.conbuildmat.2015.10.013>.
- [18] Manzi S, Mazzotti C, Bignozzi MC. Short and long-term behavior of structural concrete with recycled concrete aggregate. *Cem Concr Compos* 2013;37:312–8. <http://dx.doi.org/10.1016/j.cemconcomp.2013.01.003>.
- [19] Corinaldesi V. Mechanical and elastic behaviour of concretes made of recycled-concrete coarse aggregates. *Constr Build Mater* 2010;24:1616–20. <http://dx.doi.org/10.1016/j.conbuildmat.2010.02.031>.
- [20] Fathifazl G, Ghani Razaqpur A, Burkan Isgor O, Abbas A, Fournier B, Foo S. Creep and drying shrinkage characteristics of concrete produced with coarse recycled concrete aggregate. *Cem Concr Compos* 2011;33:1026–37. <http://dx.doi.org/10.1016/j.cemconcomp.2011.08.004>.
- [21] Seara-Paz S, González-Fontebo B, Martínez-Abella F, González-Taboada I. Time-dependent behaviour of structural concrete made with recycled coarse aggregates. Creep and shrinkage. *Constr Build Mater* 2016;122:95–109. <http://dx.doi.org/10.1016/j.conbuildmat.2016.06.050>.
- [22] González-Fontebo B, Martínez-Abella F, Carro López D, Seara-Paz S. Stress-strain relationship in axial compression for concrete using recycled saturated coarse aggregate. *Constr Build Mater* 2011;25:2335–42. <http://dx.doi.org/10.1016/j.conbuildmat.2010.11.031>.
- [23] Sánchez de Juan M. Estudio sobre la utilización de árido reciclado para la fabricación de hormigón estructural. *Ing Civ Construcción/ETSI Caminos, Canales Y Puertos* 2004. Tese de Do:502.
- [24] Nealen A, Schenk S. The influence of recycled aggregate core moisture on freshly mixed and hardened concrete properties. *Darmstadt Concr* 1998:13.
- [25] Sagoe-Crentsil KK, Brown T, Taylor AH. Performance of concrete made with commercially produced coarse recycled concrete aggregate. *Cem Concr Res* 2001;31:707–12. [http://dx.doi.org/10.1016/S0008-8846\(00\)00476-2](http://dx.doi.org/10.1016/S0008-8846(00)00476-2).
- [26] Spanish Ministry of public works. EHE-08. Regulation of Structural Concrete [in Spanish]. Madrid (Spain); 2008.
- [27] European Committee. Eurocode 2: design of concrete structures. Brussels; 2004.
- [28] González-Taboada I, González-Fontebo B, Martínez-Abella F, Carro-López D, Carro-López D. Study of recycled concrete aggregate quality and its relationship with recycled concrete compressive strength using database analysis. *Mater Construcción* 2016;66:e089. <http://dx.doi.org/10.3989/mc.2016.06415>.
- [29] González-Fontebo B, Martínez-Abella F, Eiras-Lopez J, Seara-Paz S. Effect of recycled coarse aggregate on damage of recycled concrete. *Mater Struct* 2011;44:1759–71.
- [30] Etxeberria M, Vázquez E, Marí A. Microstructure analysis of hardened recycled aggregate concrete. *Mag Concr Res* 2006;58. <http://dx.doi.org/10.1680/mac.2006.58.10.68>.
- [31] González-Fontebo B, Martínez-Abella F, Eiras-López J, Seara-Paz S. Effect of recycled coarse aggregate on damage of recycled concrete. *Mater Struct* 2011;44:1759–71. <http://dx.doi.org/10.1617/s11527-011-9736-7>.
- [32] Tam VWY, Tam CM. Diversifying two-stage mixing approach (TSMa) for recycled aggregate concrete: TSMAs and TSMAsc 2008;22:2068–77. <http://dx.doi.org/10.1016/j.conbuildmat.2007.07.02>.
- [33] Seara-Paz S, Corinaldesi V, González-Fontebo B, Martínez-Abella F. Influence of recycled coarse aggregates characteristics on mechanical properties of structural concrete 2016;20:s123–39. <http://dx.doi.org/10.1080/19648189.2016.1246694>.
- [34] Poon CS, Shui ZH, Lam L, Fok H, Kou SC. Influence of moisture states of natural and recycled aggregates on the slump and compressive strength of concrete. *Cem Concr Res* 2004;34. [http://dx.doi.org/10.1016/S0008-8846\(03\)00186-](http://dx.doi.org/10.1016/S0008-8846(03)00186-)
- [35] Spanish Ministry of public works. Spanish Building Technical Code (CTE). DB SE-AE [in Spanish]. Madrid, Spain; 2009.
- [36] González-Taboada I, González-Fontebo B, Martínez-Abella F, Pérez-Ordóñez JL. Prediction of the mechanical properties of structural recycled concrete using multivariable regression and genetic programming. *Constr Build Mater* 2016;106:480–99. <http://dx.doi.org/10.1016/j.conbuildmat.2015.12.136>.
- [37] Butler L, West JS, Tighe SL. The effect of recycled concrete aggregate properties on the bond strength between RCA concrete and steel reinforcement. *Cem Concr Res* 2011;41:1037–49. <http://dx.doi.org/10.1016/j.cemconres.2011.06.004>.
- [38] Kim SW, Yun HDo. Influence of recycled coarse aggregates on the bond behavior of deformed bars in concrete. *Eng Struct* 2013;48:133–43. <http://dx.doi.org/10.1016/j.engstruct.2012.10.009>.
- [39] Evangelista L, de Brito J. Flexural behaviour of reinforced concrete beams made with fine recycled concrete aggregates. *KSCE J Civ Eng* 2016. <http://dx.doi.org/10.1007/s12205-016-0653-> published.
- [40] Eiras-López J, Seara-Paz S, Gonzalez-Fontebo B, Martinez-Abella F. Bond behaviour of recycled concrete. analysis and prediction of bond stress-slip curve. *J Mater Civ Eng* 2017;29. [http://dx.doi.org/10.1061/\(ASCE\)MT.1943-5533.000200](http://dx.doi.org/10.1061/(ASCE)MT.1943-5533.000200).
- [41] Eguchi K, Teranishi K, Nakagome A, Kishimoto H, Shinozaki K, Narikawa M. Application of recycled coarse aggregate by mixture to concrete construction. *Constr Build Mater* 2007;21:1542–51. <http://dx.doi.org/10.1016/j.conbuildmat.2005.12.023>.