

# Voltage Regulation Method for Voltage Drop Compensation and Unbalance Reduction in Bipolar Low-Voltage DC Distribution System

Tack-Hyun Jung, Gi-Hyeon Gwon, and Chul-Hwan Kim, *Senior Member, IEEE*, Joon Han, Yun-Sik Oh, and Chul-Ho Noh

**Abstract**--Owing to the development of highly efficient electric power converters, the number of studies on the construction of low-voltage DC (LVDC) systems is gradually increasing. To use LVDC distribution systems, voltage regulation methods to compensate for the voltage drop and to limit the voltage unbalance are essential. In a bipolar LVDC distribution system, a voltage drop and voltage unbalance could occur because of the load current and the variation in the amount of power supplied to the poles. However, not enough research has been conducted on voltage regulation methods for LVDC distribution systems. To reduce the voltage drop and the voltage unbalance, this paper proposes a voltage regulation method based on the neutral to line drop compensation (NLDC) method, which employs a modified LDC to calculate the sending-end reference voltage. In the NLDC method, the neutral current and neutral line impedance are taken into consideration to compensate for the neutral line potential fluctuation and voltage drop on the pole. The next sending-end voltage is determined by checking the voltage unbalance factor, and it is adjusted to maintain it within the allowable voltage unbalance factor. A voltage regulation algorithm and a bipolar LVDC system model are implemented using ElectroMagnetic Transients Program.

**Index Terms**--Line drop compensation, low voltage DC distribution system, NLDC, voltage drop, voltage unbalance.

## I. INTRODUCTION

TO reduce the energy losses, various studies on improving the power efficiency have been performed worldwide. In this paper, the low-voltage DC (LVDC) distribution system is investigated as a solution to the power efficiency problem, because of its many advantages. With a dc distribution system, power conversion within the appliance can be avoided and losses reduced. Moreover, the LVDC system is well suited for connection of various renewable energy systems such as photovoltaic and fuel cells producing DC power by reducing the number of conversions: DC/DC/AC to DC/DC conversion. In addition, the efficiency of the microturbine and variable speed wind turbine that produce the AC power can be improved in an LVDC system by reducing the number of conversions: AC/DC/AC to AC/DC conversion [1]–[6].

An LVDC distribution system can be constructed as a unipolar or a bipolar system. A unipolar LVDC distribution system has only one voltage level with two wires, making it impossible to meet the voltage requirements of all electronic devices. On the other hand, a bipolar LVDC distribution system transfers DC power through three wires. In a bipolar system, various voltage levels can be implemented, which can decrease the potential to ground in the conductors. However, if the capacity of the loads connected to each pole is different, voltage unbalance can occur, which can adversely affect the receiving voltage [7], [8].

In order to solve the voltage unbalance problem in a bipolar LVDC distribution system, a dual-buck and half-bridge balancer that keeps the positive pole voltage equal to the negative pole voltage has been proposed and studied [7]–[10]. In addition, a buck-boost type balancer and a dual-buck half-bridge type balancer have been proposed to be employed as the requirements for power quality increase [11], [12]. However, they operate in the perspectives of electric power converters rather than the balancer output voltage by voltage drop on the distribution line. The voltage drop on the distribution line may reduce the receiving voltage, which makes the voltage regulation method for the LVDC distribution system necessary to supply an appropriate voltage level. In AC systems, the voltage drop is compensated in the distribution line by stepping up the sending voltage using the line drop compensation (LDC) method [13]–[20]. However, this method cannot calculate the proper voltage level taking into account the neutral potential fluctuation in a bipolar LVDC distribution system because it considers only the line current. This means that the LDC method cannot take into consideration the fluctuation of the neutral potential in a bipolar LVDC distribution system.

Voltage unbalance and the voltage drop are closely related to power quality in distribution systems. Therefore, this paper proposes a technique for voltage regulation in a bipolar LVDC distribution system that employs neutral to line drop compensation (NLDC) and restrains the voltage unbalance factor (VUF). This NLDC method uses the neutral current and the neutral line equivalent impedance for solving the neutral line potential fluctuation. The VUF restraint is achieved by using the objective function of the sending-end reference voltage (SERV) and the sending-end voltage (SEV). The

---

The authors are with the College of Information and Communication Engineering, Sungkyunkwan University, Suwon City, 16419, South Korea (e-mail: wjdxorgus@skku.edu; elysium03@skku.edu; chkim@skku.edu; j3angh@gmail.com; fivebal2@naver.com; chcoo87@skku.edu).

voltage regulation method with the NLDC method and VUF restraint is implemented by using EMTP and MATLAB. Various cases are simulated in order to verify its validity.

## II. VOLTAGE DROP AND UNBALANCE IN BIPOLAR LVDC DISTRIBUTION SYSTEM

### A. Load Voltage in Bipolar LVDC Distribution System

In a bipolar LVDC distribution system, the line current output from the positive pole  $I^+$  of the rectifier returns to the negative pole  $I^-$  of the rectifier as shown in Fig. 1. Assuming the balanced load condition, the magnitudes of the currents flowing on the poles are equal, i.e.,  $|I^+| = |I^-|$ . Because the current of each pole flows in the opposite direction, the magnitude of the current flowing in the neutral line becomes zero. However, assuming the unbalanced load state, the currents flowing on the poles are unequal, i.e.,  $|I^+| \neq |I^-|$ , so that the current flowing on the neutral conductor becomes  $|I^+ - I^-|$  by Kirchhoff's current law [7], [8].

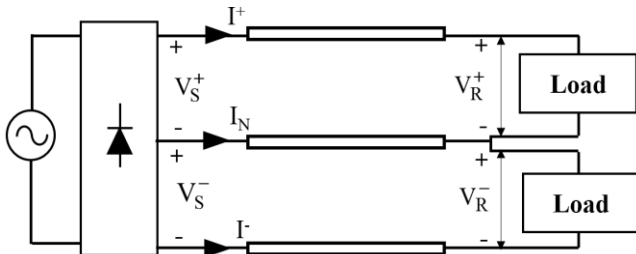

Fig. 1. Circuit diagram of bipolar LVDC system.

The receiving-end voltage of the positive pole  $V_R^+$  and the negative pole  $V_R^-$  are also affected by the current flowing through the neutral line as well as the current flowing in each pole, as shown in (1) and (2). This means that in order to calculate the load voltage exactly in the unbalanced load condition, the current flowing on the neutral line needs to be measured. The second terms of (1) and (2) represent the magnitude of the neutral line potential fluctuation, which is determined by the current flowing in the neutral line and the neutral line impedance  $r_N$  [21].

$$V_S^+ - V_R^+ = I^+ r_L + (I^+ + I^-) r_N \quad (1)$$

$$V_S^- - V_R^- = -I^- r_L - (I^+ + I^-) r_N, \quad (2)$$

where  $r_L$  is the pole line impedance and  $V_S^+$  and  $V_S^-$  are the sending voltages of the positive and the negative pole, respectively.

### B. Allowable Voltage Range

The voltage magnitude of the distribution network is the most important index for evaluating its soundness. Utilities measure the maximum and minimum customer voltages of each feeder in order to ensure the both values are within the allowable voltage range specified in the standard. Table I shows the allowable voltage range specified in the Korea Electric Power Corporation (KEPCO) standard, which restricts

the customer voltage variation within 5%–10% of each nominal voltage. However, this standard is based on AC voltage. According to Low Voltage Directive (LVD) 2006/95/EC, the range of the low voltage level is existent and that is between 75-1500V<sub>dc</sub>. However, there are no standards for the allowable voltage variation range of DC yet. It, therefore, is difficult to verify whether the proposed method in this paper can satisfy the allowable voltage range for DC. Instead, this paper has verified that the proposed method can follow a reference voltage using the performance index, which is described in more detail for its calculation in Section V. B.

TABLE I  
ALLOWABLE VOLTAGE RANGE ACCORDING TO KEPCO STANDARD

Nominal voltage [V]	Allowable range [V]
220	207 to 233 ( $\pm 13$ )
380	342 to 418 ( $\pm 38$ )
6,600	6,000 to 6,900 (-600 to +300)
22,900	20,800 to 23,800 (-2100 to +900)

### C. Definition of Voltage Unbalance

Under the unbalanced condition, the bipolar LVDC distribution system experiences the occurrence of high neutral current. As a result, this neutral current leads to the power loss on the neutral conductor and this loss makes it difficult for the operator to manage the LVDC distribution system. In addition, under a severe unbalanced situation as the worst case, the neutral conductor can be burned down due to the excessive neutral current and the similar case has been occurred in KEPCO distribution system actually. Thus, the severe voltage unbalance can cause the potentially unstable condition. To restrain the VUF, especially in AC distribution system, ANSI C84.1-1995, developed by National Electrical Manufacturers Association (NEMA), recommends that electrical supply systems be designed and operated to limit the maximum voltage unbalance within 3% [22].

In this paper, we present the VUF in the LVDC system as the voltage magnitude of the positive and negative poles, following the NEMA standard as shown in (3) because the voltage of the LVDC system has no frequency and phase [23]:

$$\%VUF = \frac{|V_{(+,dc)} - V_{(-,dc)}|}{(V_{(+,dc)} + V_{(-,dc)})/2} \times 100 \quad (3)$$

## III. VOLTAGE REGULATION USING LINE DROP COMPENSATION

The LDC method aims to keep the voltage constant at a certain point of the distribution line. Voltage control using the LDC method is performed by calculating the LDC parameters (center voltage  $V_{CE}$  and equivalent impedance  $Z_{eq}$ ) to compensate for the voltage drop by the line current  $I_L$ . Fig. 2 illustrates the concept of determining the SERV using the LDC method [24]. The concept of the LDC method can be expressed by (4), which consists of the LDC parameter and the line current [13]:

$$V_{SER} = V_{CE} + Z_{eq} I_L(t) \quad (4)$$

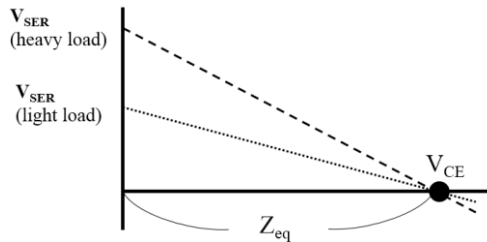

Fig. 2. Voltage regulation using LDC method.

The LDC parameter can be determined by measuring the line current and the maximum and minimum customer voltage ( $V_{n,max}$  and  $V_{n,min}$ , respectively) as well as by calculating the SERV. Equation (5) gives the objective function, which represents how much the maximum and minimum customers' feeder voltages are close to the nominal voltage  $V_{nom}$ . The SERV of a specific distribution system is determined by employing the minimum condition of (5), where the number of feeders is  $N$  [13],[15]:

$$Min J = \sum_{n=1}^N \left\{ (V_{nom} - V_{n,max})^2 + (V_{nom} - V_{n,min})^2 \right\} \quad (5)$$

The equivalent impedance and the load center voltage can be obtained with the minimum condition ( $\partial J_2 / \partial V_{CE} + \partial J_2 / \partial Z_{eq} = 0$ ) of (6) using the analytic least mean square method as shown in (7) and (8) [13], [15]–[16]:

$$Min J_2 = \sum_{n=1}^N \left\{ V_{SER} - (V_{CE} + Z_{eq} I_L(t)) \right\}^2 \quad (6)$$

$$Z_{eq} = \frac{\sum_{t=1}^T I_L(t) \times \sum_{t=1}^T V_{SER}(t) \times T \sum_{t=1}^T I_L(t) \times V_{SER}(t)}{\left( \sum_{t=1}^T I_L(t) \right)^2 - T \sum_{t=1}^T I_L(t)^2} \quad (7)$$

$$V_{CE} = \frac{\sum_{t=1}^T I_L(t) \times \sum_{t=1}^T V_{SER}(t) - Z_{eq} \sum_{t=1}^T I_L(t)^2}{\sum_{t=1}^T I_L(t)} \quad (8)$$

Here, because the ground potential fluctuation due to the unbalance current of the neutral line in the bipolar system is not considered, the LDC parameters depend only on the line current. The ground potential fluctuation of the neutral line affects the load voltage and should be considered for accurate calculation of the voltage drop compensation in a bipolar system.

#### IV. THE PROPOSED VOLTAGE CONTROL METHOD

##### A. Impact of Neutral Line Potential Fluctuation on Load Voltage

The voltage on the receiving-end  $V_R$  is determined by the

sending-end voltage  $V_{SE}$ , the line voltage drop  $\Delta V_L$ , and the ground potential fluctuation of the neutral line  $\Delta V_n$  as shown in Fig. 3 and (9). The conventional LDC method compensates for only the pole voltage drop presented in the second term of (9). The proposed NLDC method considers both the pole voltage drop and the ground potential fluctuation of the neutral line presented in the third term of (9). The sign of the third term is determined by the direction of the unbalance current due to the load unbalance. Depending on the direction of the neutral line current, the neutral line potential fluctuation intensifies the voltage drop of one pole applied to the larger load.

$$V_R = V_{SE} - \Delta V_L \pm V_n \quad (9)$$

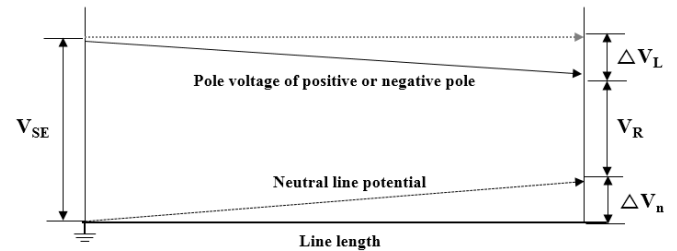

Fig. 3. Load voltage by voltage drop and ground potential of neutral line.

##### B. Calculation of NLDC Parameter

To reflect the effect of the neutral line potential fluctuation, the NLDC method includes the equivalent impedance of the neutral line  $Z_{eqn}$ . Accordingly, the SERV in the NLDC method can be represented by (10), which includes the magnitude of the neutral line current  $I_n$ . The first and second terms on the left-hand side in (10) are the NLDC parameters, which compensate for the voltage drop of the pole line, and the third term is the NLDC parameter, which compensates for the neutral line potential fluctuation. Fig. 4 shows the concept of the NLDC method considering the neutral current and the neutral line equivalent impedance. The SERV of the specific distribution line can be determined by the equation of the plane in three-dimensional coordinates:

$$V_{SER} = V_{CE} + Z_{eq} I_L(t) + Z_{eqn} I_n(t) \quad (10)$$

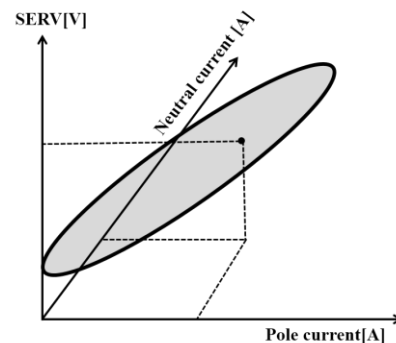

Fig. 4. Concept of NLDC method considering neutral current.

##### C. Algebraic Least Mean Square Method by Using SVD

In the analytic least mean square method of (7) and (8), each parameter can be determined by solving two simultaneous equations. In the NLDC method, however, three simultaneous

equations need to be solved to determine each parameter. Solving the three simultaneous partial differential equations is such a complicated procedure that we calculate each parameter using the algebraic least mean square method. It can be implemented by gathering the SERV, line current ( $I_L$ ), and neutral line current ( $I_n$ ) of the distribution system. The gathered data are then organized in matrix form as shown in (11). By solving the inverse matrix of  $A$  ( $A^{-1}$ ), we can determine the NLDC parameter.

$$\begin{bmatrix} I_L(1) & I_n(1) & 1 \\ I_L(2) & I_n(2) & 1 \\ I_L(3) & I_n(3) & 1 \\ \vdots & \vdots & \vdots \\ I_L(N) & I_n(N) & 1 \end{bmatrix} \begin{bmatrix} Z_{eq} \\ Z_{eqn} \\ V_{CE} \end{bmatrix} = \begin{bmatrix} V_{SER}(1) \\ V_{SER}(2) \\ V_{SER}(3) \\ \vdots \\ V_{SER}(N) \end{bmatrix} \quad (11)$$

$$A \quad \times \quad x = B$$

In (11), the inverse matrix of  $A$  is nonexistent because it is not a square matrix. In this paper, thus, we use the pseudo-inverse, which is used to compute a “best-fit” solution to a system of linear equations, to solve (11). A simple and accurate way to compute the pseudo-inverse is by using Singular Value Decomposition (SVD). If the size of the matrix is  $m$ -by- $n$ , the SVD of  $A$  is given as follows:

$$A = U \Sigma V^T, \quad (12)$$

where  $U$  is the orthonormal eigenvector of  $AA^T$ ,  $V$  is the orthonormal eigenvector of  $A^T A$ , and  $\Sigma$  is the following  $m$ -by- $n$  matrix [25]:

$$\Sigma = \begin{bmatrix} \sigma_1 & 0 & 0 & 0 \\ 0 & \ddots & 0 & 0 \\ 0 & 0 & \sigma_N & 0 \\ 0 & 0 & 0 & 0 \end{bmatrix}, \quad (13)$$

where  $\sigma$  is the singular value of matrix  $A$ , and we obtain the pseudo-inverse as (14) by taking the reciprocal of each nonzero element on the diagonal, leaving the zeros in place, and then transposing the matrix. In numerical computation, only elements larger than some small tolerance are taken to be nonzero, and the others are replaced by zeros [26].

$$A^{-1} = V \begin{bmatrix} 1/\sigma_1 & 0 & 0 & 0 \\ 0 & \ddots & 0 & 0 \\ 0 & 0 & 1/\sigma_N & 0 \\ 0 & 0 & 0 & 0 \end{bmatrix} U^T \quad (14)$$

By multiplying the inverse matrix of  $A$  on both sides of (11), we can calculate each parameter of matrix  $x$ , which consists of the equivalent impedance, the neutral line equivalent impedance, and the load center voltage. The procedure to

calculate the NLDC parameters is presented as the flowchart in Fig. 5.

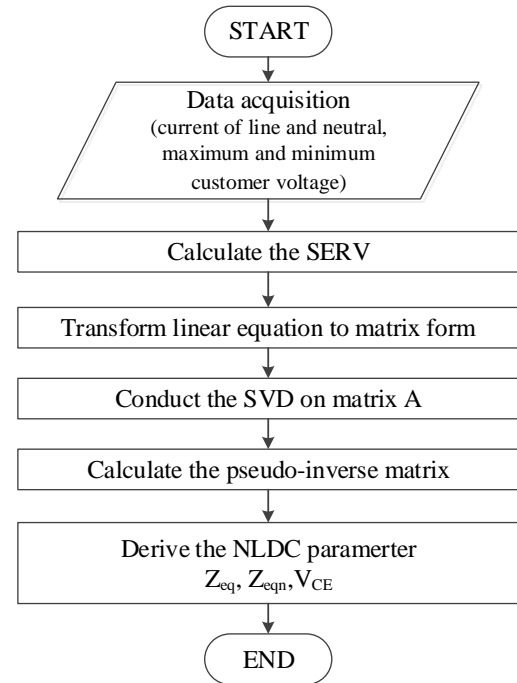

Fig. 5. Flowchart for calculation of NLDC parameter.

#### D. VUF Control

If the load difference between the positive pole and the negative pole is large, the SERV calculated from the NLDC parameter may exceed the allowable range of the VUF [19]–[20]. In this paper, to suppress the VUF along the entire distribution line, the SERV is adjusted to restrict the VUF to the allowable range. Equations (15) and (16) give the ranges of the allowable VUF ( $\varepsilon$ ) for each standard. The VUF tolerance band of the SERV is presented as a schematic diagram in Fig. 6. When the SERVs of the positive and negative poles are located between the two graphs, the allowable VUF is satisfied.

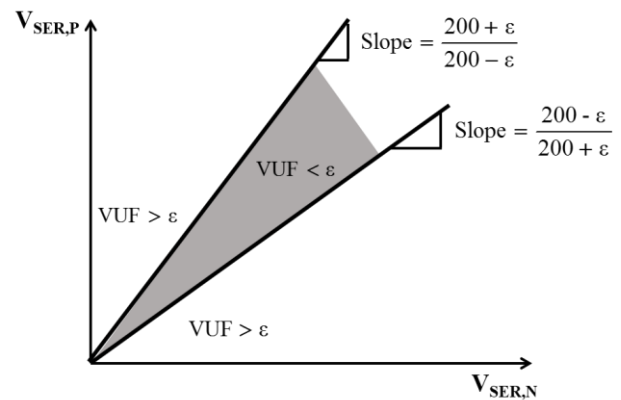

Fig. 6. VUF tolerance band of SERV.

$$V_{SER,P} < \left( \frac{200 + \varepsilon}{200 - \varepsilon} \right) V_{SER,N}, \quad \text{if } V_{SER,P} > V_{SER,N} \quad (15)$$

$$V_{SER,P} > \left( \frac{200 - \varepsilon}{200 + \varepsilon} \right) V_{SER,N}, \quad \text{if } V_{SER,P} < V_{SER,N} \quad (16)$$

To cooperate with the voltage drop compensation, if the measured VUF exceeds the allowable range, we adjust the SERV so that it stays within the boundary condition of the allowable VUF. Equation (17) is the objective function that expresses the difference between the SERV and the SEV. The SEV under the condition that the VUF exceeds the allowable range is determined by employing the minimum condition ( $\partial Q/\partial V_{SER,P}$  or  $\partial Q/\partial V_{SER,N}$ ) of the objective function.

$$Q = (V_{SER,P} - V_{SE,P})^2 + (V_{SER,N} - V_{SE,N})^2 \quad (17)$$

By employing the minimum condition to the objective function, in this case using  $\partial Q/\partial V_{SER,P}$ , we calculate the SEV of the positive pole from (18), where the  $K$  shown in (20) is the constant that is determined by the allowable VUF and the SERVs of the positive and negative poles. By dividing (18) by  $K$ , the SEV of the negative pole is calculated with (19).

$$V_{SE,P} = \frac{K^2 V_{SER,P} + K V_{SER,N}}{K^2 + 1} \quad (18)$$

$$V_{SE,N} = \frac{K V_{SER,P} + V_{SER,N}}{K^2 + 1} \quad (19)$$

$$K = \begin{cases} \left( \frac{200 + \varepsilon}{200 - \varepsilon} \right), & \text{if } V_{SER,P} > V_{SER,N} \\ \left( \frac{200 - \varepsilon}{200 + \varepsilon} \right), & \text{if } V_{SER,P} < V_{SER,N} \end{cases} \quad (20)$$

Fig. 7 shows the flowchart of the proposed voltage regulation using the NLDC method and the VUF restraints. The SERV determined with the NLDC parameter is calculated from the measured line current and the neutral line current. The VUF of the positive and negative poles is then measured. If the VUF lies within the allowable range, the SERV calculated with the NLDC parameter becomes the SEV without any adjustment. If not, the SERV is adjusted in accordance with (18) and (19) in order to satisfy the standard of the VUF.

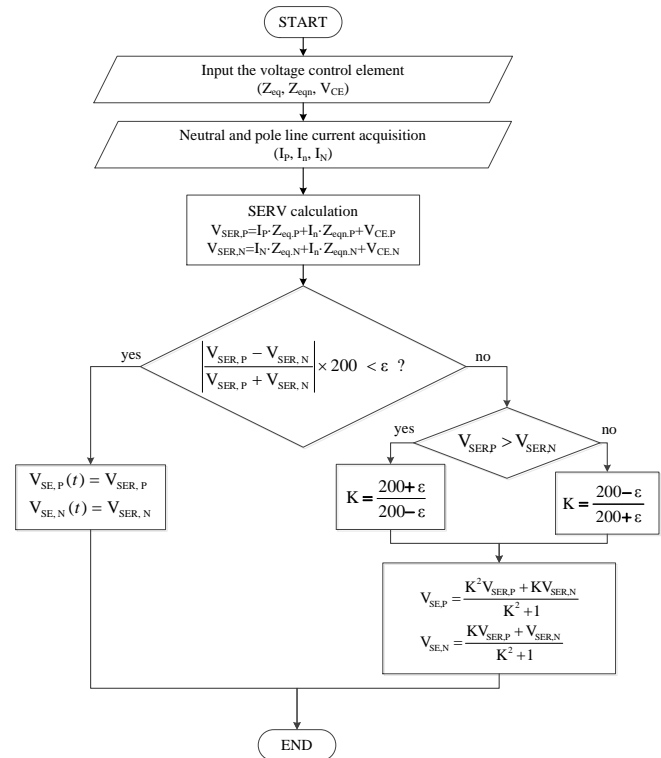

Fig. 7. Flowchart of the proposed voltage regulation method.

## V. SIMULATION AND RESULTS

### A. Modeling of the LVDC Distribution System

To verify the proposed voltage regulation method, a radial bipolar LVDC system is modeled as shown in Fig. 8. An AC/DC converter is used to interconnect the AC grid and DC grid, and a boost balancer is used to supply the regulated voltage to both the positive and negative poles. The receiving ends designated N-2 to N-5 are modeled as a step-down DC/DC converter and resistive load. ACSR (160 mm<sup>2</sup>) for two poles and ACSR (95 mm<sup>2</sup>) for the neutral line are modeled, and the length between each receiving end is 200m. More detailed parameter is tabulated in Table II.

TABLE II  
DATA OF SIMULATION SYSTEM

Model	Explanation
AC/DC converter	3-phase SPWM full-bridge converter
DC/DC converter	Typical buck converter with fixed duty ratio
Pole conductor	ACSR 160mm <sup>2</sup> (R <sub>in</sub> : 0.39cm, R <sub>out</sub> : 0.91cm, Resistance(DC): 0.182Ω/km)
Neutral conductor	ACSR 95mm <sup>2</sup> (R <sub>in</sub> : 0.225cm, R <sub>out</sub> : 0.675cm, Resistance(DC): 0.301Ω/km)
Length between loads	200m
Load	Resistive load, each load is 30kW (4.8133Ω)
Line voltage	±750V <sub>dc</sub>
Customer voltage	380V <sub>dc</sub>

In this paper, a simple buck DC/DC converter with fixed duty ratio is adopted. It is proper in terms of economics because the distribution system has many loads and requires a lot of DC/DC converters with high capacity. In EMTP simulation, the converter is modeled using the Transient Analysis of Control System (TACS) element and MODELS function, which is the user defined model based on Fortran interface. This EMTP does not provide the model of power electronic converter and semiconductor switch. Therefore, the semiconductor switch is modeled using an antiparallel diode element and TACS-controlled TYPE 13 switch, which has on/off action according to control signal. This signal is generated through MODELS.

The control type of buck DC/DC converter used in this paper is the fixed duty ratio, which is one of the several control method such as PWM. Since this paper focuses on the line voltage and neutral current in the LVDC distribution system, the simple and typical method to control the buck converter is used. The control signal of this buck converter is generated by the pulse train depending on the duty ratio in MODELS.

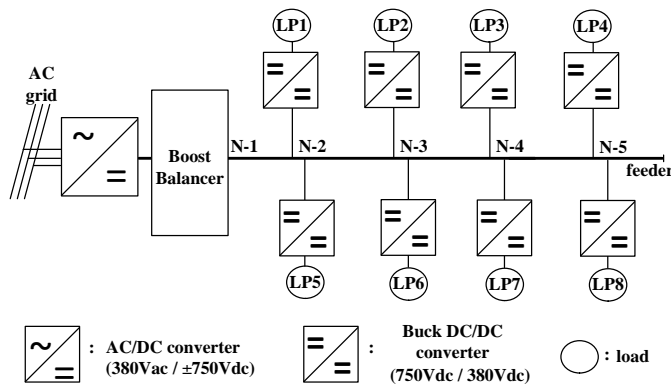

Fig. 8. Simulation system.

In order to simulate the load magnitude variation with time, we use the daily load curve expressed as a percentage as shown in Fig. 9, which is taken from the actual load data during the day for the summer season in Korea. Table III shows the simulation conditions. We simulate the unbalanced load condition by fixing the load capacity of the negative pole as 120 kW and by changing that of the positive pole.

TABLE III  
SIMULATION CONDITIONS

Case	Ratio of load capacity (Positive : Negative)	Load Unbalance Factor[%]	Allowable VUF[%]
1	1.0 : 1.0	0	3
2	1.1 : 1.0	9.52	
3	1.2 : 1.0	18.18	
4	1.3 : 1.0	26.09	
5	1.4 : 1.0	33.33	
6	1.5 : 1.0	40	

With respect to the simulation model, we collect the SERV, line current, and neutral current data and represent them as dots to calculate the LDC and NLDC parameters as shown in Figs. 9 and 10. Fig. 10 shows the measured data and graphical expression of the LDC parameter. Fig. 11 shows the measured data and the graphical depiction of the NLDC parameter. Table IV shows the voltage regulation parameter for each method.

TABLE IV  
VOLTAGE REGULATION PARAMETER FOR EACH METHOD

Method	LDC or NLDC parameter
Fixed voltage	$V_{SER,P} = 750V_{dc}$ $V_{SER,N} = 750V_{dc}$
LDC	$V_{SER,P} = 0.23I_p + 732.294$ $V_{SER,N} = -0.23I_N + 732.294$
NLDC	$V_{SER,P} = 0.092I_p - 0.129I_n + 748.108$ $V_{SER,N} = -0.092I_N + 0.129I_n + 748.108$

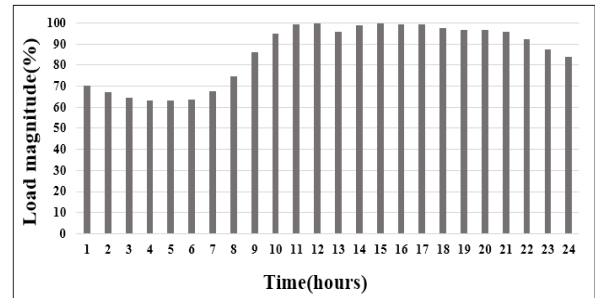

Fig. 9. Daily load curve for simulation.

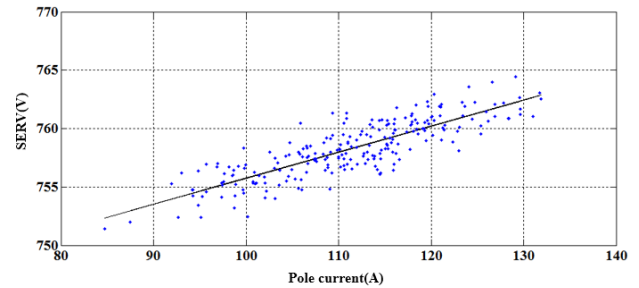

Fig. 10. Measured data and LDC parameter of simulation model.

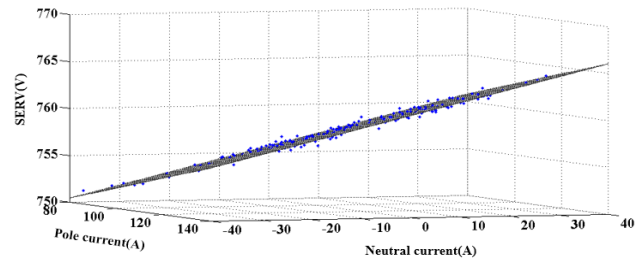

Fig. 11. Measured data and NLDC parameter of simulation model.

## B. Simulation Results

### 1) Voltage drop compensation results

Fig. 12 shows the maximum and minimum customer-end voltages of Case 4 when the fixed current voltage method is applied. As shown in Fig. 12, the voltage drop of the positive pole is relatively larger than that of the negative pole. These results

are due not only to the difference between the voltage drop of each pole, but also to the potential fluctuation of the neutral line. As mentioned before, the potential fluctuation of the neutral line intensifies the voltage drop of the pole supplying a large load, while suppressing the voltage drop of the pole supplying a light load. As shown in Fig. 13, the larger the voltage unbalance, the larger the potential fluctuation of the neutral.

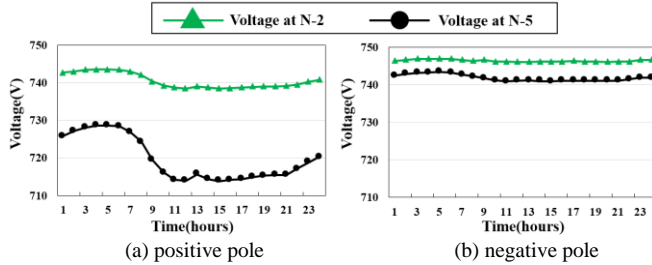

Fig. 12. Simulation results of Case 4 (fixed voltage method).

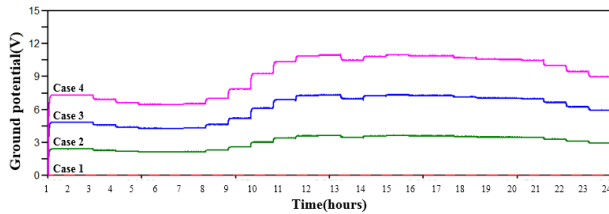

Fig. 13. Ground potential of neutral line for simulation cases.

Figs. 14 and 15 show the maximum and minimum customer-end voltages of Case 4 when using the LDC and NLDC methods, respectively. When employing the NLDC method, the maximum and minimum customer-end voltages represent a symmetrical voltage waveform relative to 750 V. Further, we can conclude that the NLDC method achieves optimal voltage drop compensation by minimizing the objective function shown in (6). However, when employing the LDC method, the minimum customer-end voltage of the positive pole is close to 750 V, and that of the negative pole is over 750 V. This is because the LDC parameter does not consider the neutral current, and depends only on the line current. On the other hand, the NLDC parameter considers both the neutral and line currents, enabling optimal voltage compensation depending on the potential fluctuation of the neutral line.

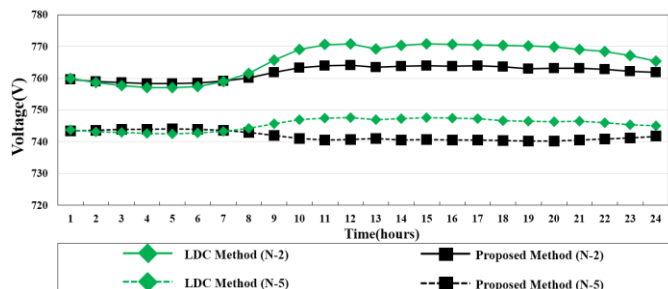

Fig. 14. Comparison of LDC and NLDC methods for positive pole.

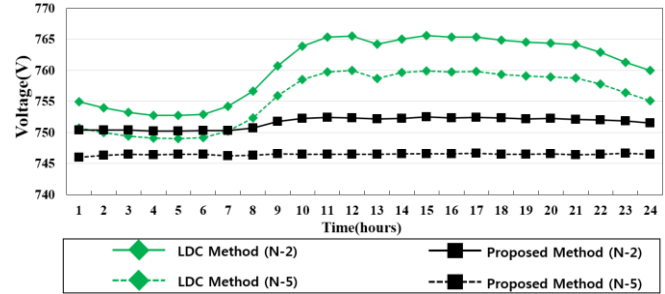

Fig. 15. Comparison of LDC and NLDC methods for negative pole.

### 2) Estimation of Voltage drop compensation

The Performance Index (PI) is an index to evaluate voltage regulation performance, which can be expressed as follows:

$$PI = \sum_{t=1}^T \sum_{n=1}^N \left\{ (V_{n,max}(t) - V_{nom}(t))^2 + (V_{n,min}(t) - V_{nom}(t))^2 \right\}, \quad (21)$$

where  $V_{n,max}$  and  $V_{n,min}$  are the maximum and minimum voltages of customers at each feeder, respectively, and  $V_{nom}$  is the nominal voltage.

The smaller the magnitude of the PI, the closer the voltage at each node is to the nominal voltage [13], [15]. Fig. 16 shows the PI under various simulation conditions in each method for voltage drop compensation. As shown in Fig. 16, the PIs of the NLDC method are the smallest values among all the simulation conditions. In conclusion, the NLDC method implements the appropriate voltage drop compensation to maintain the overall voltage in the distribution line close to the nominal voltage.

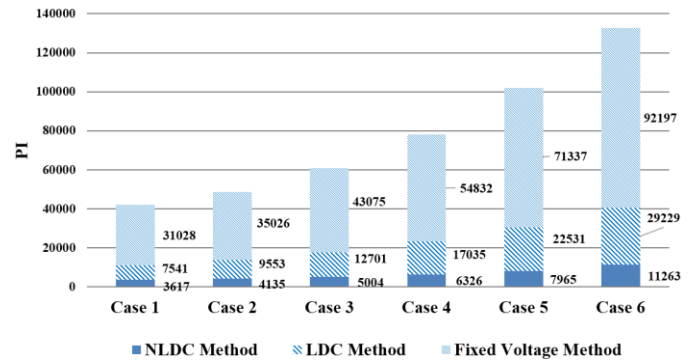

Fig. 16. Performance index under various simulation conditions and methods.

### 3) VUF restraints

In Cases 5 and 6, because the difference in load capacity between the positive and negative poles is quite large, the VUF exceeds the allowable range. Fig. 17 shows the measurement results of the VUF for each method. In Fig. 17(a), when the fixed voltage method is adopted, the VUF increases as it is far from the source. In addition, most of the node voltages exceed the allowable VUF of 3%. With the NLDC method, the overall VUF decreases compared to the former value as shown in Fig. 17(b). However, the VUF in N-1 is measured relatively high because the SEV is adjusted with reference to the NLDC parameter. When performing the VUF restraint control, the

maximum VUF occurs at the SEV, and the overall VUF of the distribution line is restricted below the allowable voltage unbalance factor of 3%. Additionally, to demonstrate the effectiveness of the proposed method for the situation other than the load variation, the simulation for load shedding is conducted. As shown in Fig. 17, the load shedding is occurs at 19:00 in LP6. As a result, the VUF increases greatly at that time. The fixed voltage method and NLDC method without VUF control cannot restrict the high voltage unbalance. On the other hands, as shown in Fig. 17(c), the NLDC with VUF control mitigates high VUF successfully below 3%. Consequentially, this results show the effectiveness and the robustness of the proposed method. Also, it can be effective for the improvement of power quality, and enable the secure and the reliable operation of the power system.

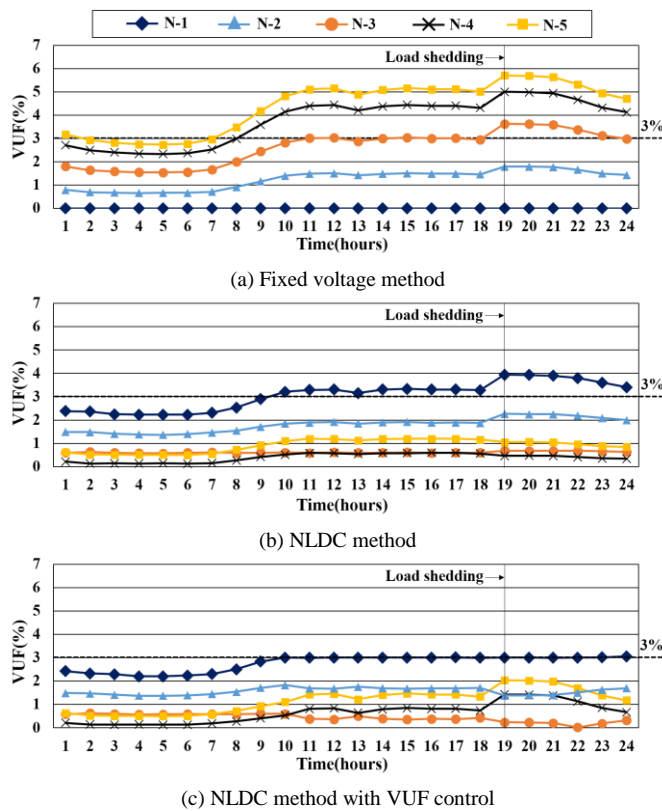

Fig. 17. VUFs in Case 5 for each method.

## VI. CONCLUSION

This paper proposes a novel technology to compensate for the voltage drop and voltage unbalance in a bipolar LVDC distribution system. The NLDC method, which takes the neutral line current and neutral line equivalent impedance into consideration, compensates for the pole line voltage drop and reduces the neutral potential fluctuation. In order to verify the proposed method, a bipolar LVDC distribution system is modeled, and a boost balancer is implemented by using EMTP. In addition, the algebraic least mean square is used to determine NLDC parameters such as the SERV and the line current by using MATLAB. The simulation results confirm that the proposed method is effective in compensating for the voltage drop and in mitigating the voltage unbalance in bipolar

LVDC distribution systems. The simulation results show that the smallest PI is obtained by the NLDC method, and not by the conventional methods. This is because the neutral potential fluctuation largely depends on the neutral current generated by the load unbalance condition. Moreover, it is verified that the NLDC method is useful in mitigating the voltage unbalance. In conclusion, the proposed method contributes to the improvement of voltage regulation and the effective mitigation of the voltage unbalance in bipolar LVDC distribution systems by providing better performance than the existing methods.

## ACKNOWLEDGEMENT

This work was supported by the National Research Foundation of Korea (NRF) grant funded by the Korea government (MSIP) (No. 2015R1A2A1A10052459).

## REFERENCES

- [1] Hammerstrom, D.J., "AC Versus DC Distribution Systems-Did We Get it Right?," *IEEE Power Engineering Society General Meeting, 2007*, pp.1-5, June 2007.
- [2] Daniel Nilsson, "DC Distribution Systems," Division of Electric Power Engineering Department of Energy and Environment CHALMERS UNIVERSITY OF TECHNOLOGY, Sweden 2005.
- [3] Pasi Salonen, Tero Kaipia, Pasi Nuutinen, Pasi Peltoniemi and Jarmo Partanen, "An LVDC Distribution System Concept," *Nordic Workshop on Power and Industrial Electronics*, June 2009.
- [4] Kazmi Syed Muhammad Raza, Hiroki Goto, Hai-Jiao Guo and Osamu Ichinokura, "Maximum power point tracking control and voltage regulation of a DC grid-tied wind energy conversion system based on a novel permanent magnet reluctance generator," *International Conference on Electrical Machines and Systems*, pp. 1533-1538, 2007.
- [5] M. Ndreko, M. Popov, J. L. Rueda-Torres and M. A. M. M. van der Meijden, "Impact of offshore wind and conventional generation outages on the dynamic performance of AC-DC transmission systems," *PowerTech, 2015 IEEE Eindhoven*, pp. 1-6, 2015.
- [6] M. Hadjikypris and V. Terzija, "Transient fault studies in a multi-terminal VSC-HVDC grid utilizing protection means through DC circuit breakers," *PowerTech, 2013 IEEE Grenoble*, pp. 1-6, 2013.
- [7] Kakigano, H., Miura, Y., Ise, T., Uchida, R., "DC Voltage Control of the DC Micro-grid for Super High Quality Distribution", *Power Conversion Conference - Nagoya, 2007*.
- [8] Kakigano, H.; Miura, Y.; Ise, T., "Low-Voltage Bipolar-Type DC Microgrid for Super High Quality Distribution," *IEEE Transactions on Power Electronics*, vol.25, no.12, pp.3066-3075, Dec. 2010.
- [9] Salomonsson, D.; Sannino, A., "Low-Voltage DC Distribution System for Commercial Power Systems With Sensitive Electronic Loads," *IEEE Transactions on Power Delivery*, vol.22, no.3, pp.1620-1627, July 2007.
- [10] Lago, J.; Moia, J.; Heldwein, M.L., "Evaluation of power converters to implement bipolar DC active distribution networks — DC-DC converters," *Energy Conversion Congress and Exposition (ECCE), 2011 IEEE*, pp.985-990, Sep 2011.
- [11] Chi Zhang; Daozhuo Jiang; Huan Zheng; Lixin Ye, "A Bi-Directional Buck/Boost Voltage Balancer for DC Distribution System," *2013 Fourth International Conference on Digital Manufacturing and Automation (ICDMA)*, pp.9-13, June 2013.
- [12] Xianjin Zhang; Chunying Gong, "Dual-Buck Half-Bridge Voltage Balancer," *IEEE Transactions on Industrial Electronics*, vol.60, no.8, pp.3157-3164, Aug 2013.
- [13] J. H. Choi and J. C. Kim, "Advanced voltage regulation method of power distribution systems interconnected with dispersed storage and generation systems," *IEEE Transactions on Power Delivery*, vol.16, no.2, pp.329-334, Apr 2001.
- [14] Chensong Dai and Y. Baghzouz, "Impact of distributed generation on voltage regulation by LTC transformer," *Harmonics and Quality of Power, 11th International Conference on*, USA, pp. 770-773, 2004.
- [15] Dae. Seok Rho, Kyung Soo Kook, Yong Peel Wang, "Optimal Algorithms for Voltage Management in Distribution Systems



Interconnected with New Dispersed Sources”, *Journal of Electrical Engineering & Technology*, Vol. 6, No. 2, pp. 192-201, 2011.

- [16] Yun-Seok Ko, “The On-Line Voltage Management and Control Solution of Distribution Systems Based on the Pattern Recognition Method”, *Journal of Electrical Engineering & Technology*, Vol. 4, No. 3, 330 pp. 330~336, 2009.
- [17] P. P. Barker and R. W. De Mello, "Determining the impact of distributed generation on power systems. I. Radial distribution systems," *Power Engineering Society Summer Meeting*, Seattle, vol. 3, pp.1645-1656, 2000.
- [18] J. M. Triplett and S. A. Kufel, "Implementing CVR through voltage regulator LDC settings," *Rural Electric Power Conference (REPC)*, 2012 IEEE, Milwaukee, pp.B2-1-B2-5, 2012.
- [19] C. A. Smith, M. A. Redfern and S. Potts, "Improvement in the performance of on-load tap changer transformers operating in series," *Power Engineering Society General Meeting*, vol.3, 2003.
- [20] Tsai-hsiang Chen, Min-sian Wang, Nien-che Yang, "Impact of Distributed Generation on Voltage Regulation by ULTC Transformer using Various Existing Methods," *Proceedings of the 7th WSEAS International Conference on Power Systems*, Beijing, China, September 15-17, 2007.
- [21] Boeke, Ulrich, and Matthias Wendt. "Comparison of low voltage AC and DC power grids." Philips Research, AE Eindhoven, Netherlands.
- [22] American National Standard for Electric Power Systems Equipment—Voltage Ratings (60 Hertz), ANSI C84.1-1995.
- [23] Von Jouanne, A.; Banerjee, B., "Assessment of voltage unbalance," *IEEE Transactions on Power Delivery*, vol.16, no.4, pp.782,790, Oct 2001.
- [24] A. L. M. Mufaris, J. Baba, S. Yoshizawa and Y. Hayashi, "Determination of dynamic line drop compensation parameters of voltage regulators for voltage rise mitigation," *2015 International Conference on Clean Electrical Power (ICCEP)*, Taormina, pp.319-325, 2015.
- [25] Klema, V.; Laub, A.J., "The singular value decomposition: Its computation and some applications," *IEEE Transactions on Automatic Control*, vol.25, no.2, pp.164-176, Apr 1980.
- [26] Golub, Gene H.; Charles F. Van Loan (1996). *Matrix computations* (3rd ed.). Baltimore: Johns Hopkins. pp. 257–258.

His research interests include power system protection, artificial intelligence application for protection and control, modeling/protection of underground cables, and EMTP software.



**Joon Han** received his B.S. degree from School of Electrical Engineering, Soonchunhyang University, Asan, Republic of Korea, in 2011 and his M.S. degree from College of Information and Communication Engineering, Sungkyunkwan University, Suwon, Republic of Korea, in 2013, where he is currently pursuing Ph.D. degree in electrical engineering.

His research interests include power system transients, protection, and stability in DC system.



**Yun-Sik Oh** received his B.S. and M.S. degrees from College of Information and Communication Engineering, Sungkyunkwan University, Suwon, Republic of Korea, in 2011 and 2013, respectively, where he is currently pursuing the Ph.D. degree in electrical engineering.

His research interests include power system transients, protection, and stability.



**Chul-Ho Noh** received the B.S. degree from College of Information and Communication Engineering, Sungkyunkwan University, Suwon, Republic of Korea, in 2013, where he is currently pursuing combined Ph.D. degree in electrical engineering.

His research interests include power system transients, power quality, and protection schemes and coordination, especially in DC distribution systems.



**Tack-Hyun Jung** was received the B.S. and M.S. degrees from College of Information and Communication Engineering, Sungkyunkwan University, Suwon, Republic of Korea, in 2013 and 2015, respectively.

His research interests include power system protection and stability in DC distribution systems.



**Gi-Hyeon Gwon** received his B.S. and M.S. degrees from College of Information and Communication Engineering from Sungkyunkwan University, Suwon, Republic of Korea, in 2012 and 2014, respectively, where he is currently pursuing the Ph.D. degree in electrical engineering.

His research interests include power system transients, protection, and stability in DC distribution system.



**Chul-Hwan Kim** (M'90-SM'04) received the B.S., M.S. and Ph.D. degrees in Electrical Engineering from Sungkyunkwan University, Suwon, Republic of Korea, in 1982, 1984, and 1990, respectively.

In 1990, he joined Jeju National University, Jeju, Republic of Korea, as a full-time Lecturer. He has been a visiting academic at the University of Bath, UK, in 1996, 1998, and 1999. Since March 1992, he has been a professor in the College of Information and Communication, Sungkyunkwan University,

Republic of Korea.