

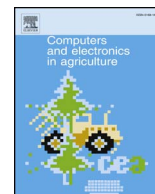

Contents lists available at ScienceDirect

Computers and Electronics in Agriculture

journal homepage: www.elsevier.com/locate/compag

Original papers

Multi-level automation of farm management information systems

Dimitris S. Paraforos^{a,*}, Vangelis Vassiliadis^b, Dietrich Kortenbruck^{a,c}, Kostas Stamkopoulos^b, Vasileios Ziogas^b, Athanasios A. Sapounas^b, Hans W. Griepentrog^a^a University of Hohenheim, Institute of Agricultural Engineering, Technology in Crop Production, Garbenstr. 9, D-70599 Stuttgart, Germany^b Agrostis Agricultural Information Systems, A. Tritsi 21, Pylaia, 57001, Thessaloniki, Greece^c EXA Computing GmbH, Münsterstr. 5, D-59065 Hamm, Germany

ARTICLE INFO

Keywords:

Field clustering

Future Internet

ISO 11783

J1939

Standard values

ABSTRACT

As innovative information and communication technology (ICT) tools were gradually introduced over the past decades into the agricultural sector, the use of farm management information systems (FMIS) was widely expanded and nowadays are regarded as important tools for managing the agricultural business. Nevertheless, the necessary workload for collecting, aggregating and importing data related to farming activities into a FMIS, is a task which is often time-consuming and farmers are reluctant to perform. The current paper describes the implementation of three automation levels, which enhance a FMIS by providing solutions related to the collection of fragmented-missing data and time-consuming data entry. The three levels involve: (i) the development of a modular FMIS based on future internet technologies, (ii) the use of standard values for assessing the cost of performed agricultural tasks and (iii) automating the process of importing task-related data into a FMIS using tractor's CAN-Bus ISO 11783 and SAE J1939 communication information. To assess the financial analysis of the developed FMIS, related data were collected, recorded and analysed for an entire growing season, from two distinct crops, i.e. winter wheat and maize. Furthermore, to assess the automated task formulation in the FMIS, machine data were acquired while ploughing with a mouldboard plough. The application proved capable of performing a profitability analysis based on the recorded cost transactions but also based on the information given by the user related to the performed tasks. With the automatically created task, the FMIS gave the possibility to the user to present and process the necessary information with minimum effort.

1. Introduction

The level of complexity for farming enterprises has been gradually increasing over the last decades. From simple production units, which supplied the population with affordable and sufficient food quantities, they have turned into agricultural businesses with multifunctional service sectors. In today's competitive environment, a farm can survive financially and be sustainable only when it is well managed (Husemann and Novković, 2014). However, farm management is a challenging and time-consuming task (Doyle et al., 2000) with existing associated problems such as lack of time for in-field monitoring of tasks, and difficulty to manage finances and subsidies. Furthermore, the increase of the area per farmer during the last decades can explain the decision support that farmers need nowadays. These problems are complicated to handle due to the lack of suitable dedicated hardware and software. To be able to monitor and manage online data collection in the field, farmers require additional information and proper technologies, which recently have even entered the Big Data sector (Wolfert et al., 2017). The

combination of proper time-related information with careful decision-making is the key factor for a successful agricultural business (Singh et al., 2008).

The technological progress in computer hardware and software has enabled an effective computer-based support process, which facilitates farmer's decision-making via the manipulation of increased quantity and quality of available information (Lewis, 1998) and, therefore, contributing to the challenge of a complex farm management. Furthermore, the increase of the Information and Communication Technology (ICT) tools during the last decade in precision farming is noticeable (Kaivosoja et al., 2014). In order to be capable of drawing benefits from available databases, farmers have to collect, process, provide and use data in an efficient way.

Farm Management Information Systems (FMIS) store and process farm data for everyday farm management (Fountas et al., 2015a). There are a number of different types of system structures and software architectures offered (Ampatzidis et al., 2016; Nikkilä et al., 2010; Sørensen et al., 2011; Tsiropoulos et al., 2013). At the same time,

* Corresponding author.

E-mail address: d.paraforos@uni-hohenheim.de (D.S. Paraforos).<https://doi.org/10.1016/j.compag.2017.11.022>

Received 16 June 2017; Received in revised form 20 September 2017; Accepted 13 November 2017

0168-1699/ © 2017 Elsevier B.V. All rights reserved.

various commercial solutions are available (365FarmNet, AgriWebb, Agworld, FarmLogs and FarmWorks, just to name a few) with the number of FMIS providers to be rapidly increasing.

New trends such as cloud computing and Future Internet (FI) technologies have also been implemented in the development of a FMIS (Kaloyxos et al., 2014, 2012; Paraforos et al., 2016). The FI provides a library of software components that are called Generic Enablers (GEs). The GEs are public and open-source and allow developers to create mash-up applications by implementing innovative FI functionalities such as Cloud Computing, Internet of Things (IoT) connectivity, and Big Data analytics. All GEs are developed and described in detail as a set of Application Programming Interfaces (APIs) in the FIWARE¹ platform. The list of GEs is being updated regularly, with many independent providers building new innovative tools that could be potentially integrated in the future into the FMIS.

A properly developed FMIS proves its valuable ability toward a successful farm management via the provided allocation of scarce resources and profit maximisation (Verstegen et al., 1995). The FMIS has to be capable of monitoring farm's production and business processes including planning, organising, monitoring and controlling. Special attention should be given to the internal interdependencies of production and services branches. Also, the FMIS must be easy to comprehend. The information system can support farmer's decision-making and lead to profit augmentation only when farmers' demands are fully met (Husemann and Novković, 2014). Software after-sale support service is of high importance as if this does not meet their requirements and does not provide efficient help, farmers tend to seek new software providers and vendors.

In order for a farmer to receive valuable information from a state-of-the-art FMIS, all details related to the performed agricultural operations should be carefully recorded and imported into a FMIS. A common problem is that these agricultural tasks are not recorded properly; additionally, a farmer often neglects to gather all necessary data and import them into a FMIS (Paraforos et al., 2016). A solution that appears promising is to utilise agricultural machinery communication data. The connection of ISO 11783 (ISOBUS) with a FMIS has been described in detail in Part 10 of the standard (ISO, 2014). Data are obtained from the machines' sub-systems (e.g. different sensors and electronic control units), which are initially installed for the correct operation as well as for the real-time inter-machine communication (Fountas et al., 2015b; Kortenbruck et al., 2017).

This is taken into account in recent trends aimed to improve the functionality of the FMIS. A methodology for gathering agricultural process data from ISOBUS was introduced by Steinberger et al. (2009). These data were transmitted to a server for further analysing and task formulation. The onboard data management and integration of mobile devices were presented and evaluated by Blank et al. (2013) focusing on data sharing in wheat and forage harvesting. Oksanen et al. (2015) also performed remote access of ISOBUS data. A number of commercial solutions in the field of machinery fleet management are already present: CLAAS Telematics, John Deere JDLink, AGCO AgCommand, etc. but usually these solutions support machines from the same brand or partner companies.

The aim of this study is to describe the FMIS architecture that can incorporate different automation levels, in order to minimise farmers' effort and time to perform data entry into the FMIS. A significant advance would be the establishment of a solution towards fragmented or missing data sets. Standard values could be used to calculate the cost of a farming task even when no specific data are provided by the user. These values could be given by the farmers based on their experience or could be acquired from existing databases which can also provide this information for specific regional conditions. A second improvement would be to automate the process of importing task-related data into a

FMIS since necessary information that farmers import into a FMIS could be obtained by recording tractor's CAN-Bus ISO 11783 and SAE J1939 communication information.

The contribution of the present work, focusing mainly on small and medium-size farms, whose machinery fleet is not so advanced, is based on the combination of the following three automation levels: (1) Use of new ICT tools for developing a modular FMIS; (2) Use of standard values, related to predefined farming activities, for performing financial analysis for the entire growing season; and (3) Automated machine data acquisition for importing task-related information into an FMIS.

2. Materials and methods

2.1. The FMIS

A cloud-based FMIS, which is commercially available by Agrostis Agricultural Information Systems (Thessaloniki, Greece), named *ifarma*², was chosen to be automated according to the three described automation levels. *Ifarma* is an integrated farm management, which is being offered as a subscription-based application and can be used by farmers, who wish to utilise mobile devices and modern technologies. The main purpose of *ifarma* is to plan, monitor and keep a record of all farming activities during the cultivating season. Detail tracking of quantities and cost of all inputs and resources, such as workers, machines, seeds, fertilisers, plant protectants is also available.

The *ifarma* backend is a cloud-based application which operates the main FMIS service. This service communicates with the main database of the FMIS where all farmer's data are stored. For managing all imported data, the database management system MySQL is utilised. The Entity-Relationship model of the *ifarma* database is presented in Fig. 1. All information linked with the farm is integrated into a data model of *ifarma*. This includes fields and land parcels, crops, and agricultural activities as well as all the inputs and resources required for these activities. A hierarchical model with the farm itself on top is used to organise the datasets. The data are divided by crops, which are cultivated on one or more fields. A specific set of tasks is prescribed to each crop. Each task activity includes inputs or resources. Inputs are represented in forms of resources divided by categories such as labour, machinery, materials, equipment, etc. Farm-specific resources are represented as individual data entities such as workers, machines, fertilisers, plant protection products, etc. Both inputs and resources have their own unit cost and unit efficiency values per task, which are used to calculate the final quantity and amount of this input/resource for each task.

2.2. Instrumentation and data acquisition

To acquire machine-related data, a metal construction was developed in order to mount all the necessary instrumentation (Fig. 2) and was placed inside the cabin of a 6210R 156.6 kW tractor (John Deere, Moline, Illinois, United States) (Paraforos et al., 2017). A GL2000 CAN-Bus data logger (Vector Informatik GmbH, Stuttgart, Germany) was connected to the CAN-Bus diagnostic interface, to record J1939 and ISO 11783 communication data. The logged data were stored in a 2 GB SDHC card, which was possible to be increased up to 32 GB storage capacity. To wirelessly transmit the acquired data to the cloud-based server of the FMIS, the logger was connected with a 3G M2M (Machine to Machine) gateway (Sierra Wireless, Richmond, BC, Canada) with an installed SIM card. Every time the data had been successfully received by the application running on the server, the memory card was cleared to avoid storage capacity problems. The acquired data were georeferenced by the logger using the positioning data from a Navilock NL-603P differential global navigation satellite system (DGNSS) receiver (Tra-gant Handels- und Beteiligungs GmbH, Berlin, Germany).

¹ www.fiware.org.

² ifarma.agrostis.gr.

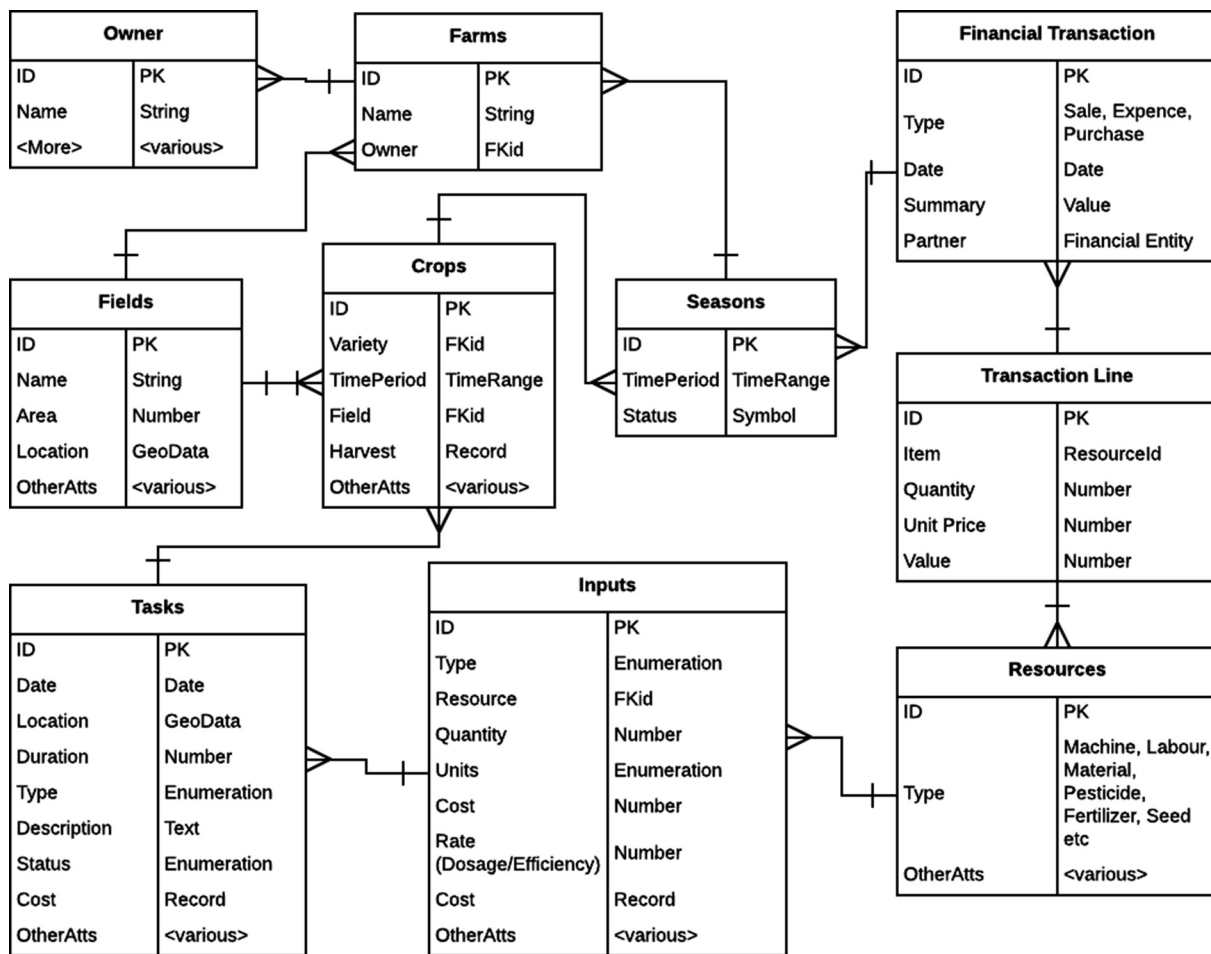

Fig. 1. Entity relationship of the ifarma FMIS.

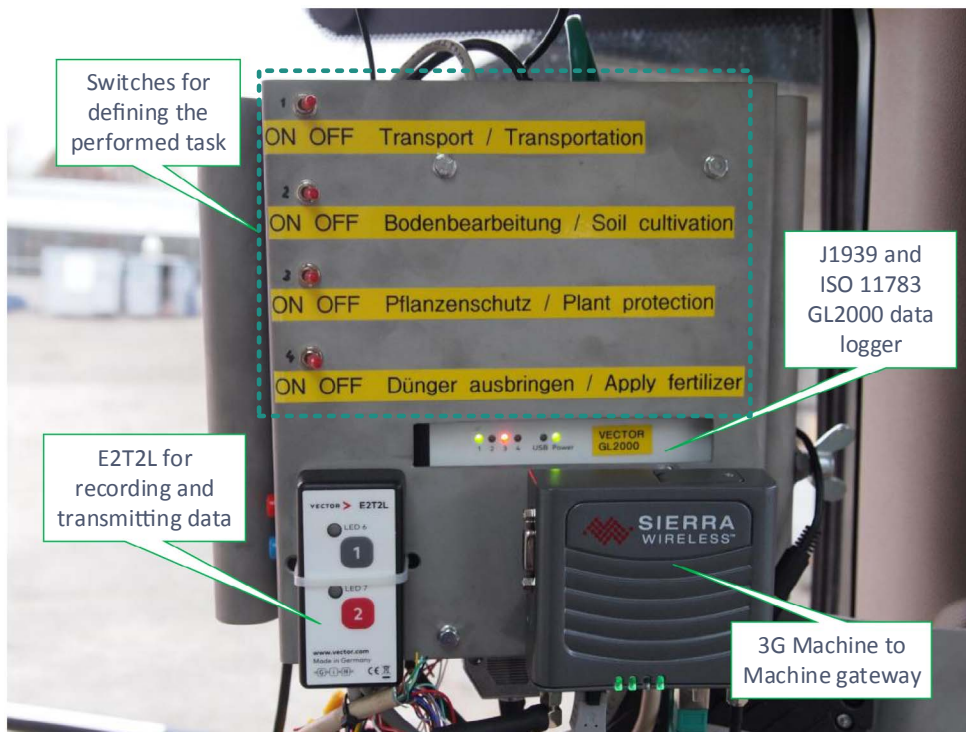

Fig. 2. Utilised instrumentation for acquisition and transmission of CAN-Bus communication data.

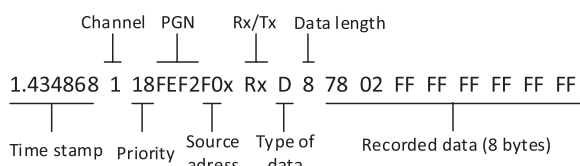

Fig. 3. An example of a CAN-Bus message as this was retrieved from the data logger.

The tractor operator was given the ability to choose the current operating mode among four possible modes (i.e. transportation, soil cultivation, plant protection, and fertiliser application) by switches, which were connected to an equal number of digital inputs of the data logger. The operator could start the data logging by pressing Button 1 of the E2T2L module (Vector Informatik GmbH, Stuttgart, Germany) as illustrated in the bottom left corner of Fig. 2. Data logging was stopped as soon as the operator would press Button 2. At the same time, the logging was stopped, the data were transmitted to the remote server using the M2M gateway. At the remote server, where the FMIS was also running, the ML (Multi Logger) Server software (G.i.N. – Gesellschaft für industrielle Netzwerke mbH, Griesheim, Germany) was responsible for receiving the data. Logged CAN-Bus messages were saved in batches in ASCII files.

The GL2000 was configured using its own configuration tool to filter the tractor's CAN-Bus communication data, and to record only the messages with specific CAN-IDs. The messages were filtered according to their parameter group number (PGN). It was configured only once, without requiring any further action by the tractor operator. An example of a CAN-Bus message as this was retrieved from the data logger is presented in Fig. 3. If one of the desired PGNs was detected, all the machine parameters based on the suspect parameter number (SPN) that were contained in the message, were read. All the messages that were recorded by the data logger and used in the present work are presented in Table 1.

Despite the asynchronous communication that resulted in data acquisition at different instances, the provided timestamp eased post-processing. Cubic spline interpolation method was used to calculate the values in desired time instances between time values of the acquired data. The time stamps of the DGNSS data were utilised as a basis for the interpolation of the data related to all CAN-Bus messages presented in Table 1. In order to extract only the in-field information, data with a value higher than 50% for rear hitch position and higher than 18 km h^{-1} were discarded.

2.3. Experimental data

In order to test the financial analysis tool of the developed FMIS, all data related to the cultivation of maize (*Zea mays* L.) for silage and winter wheat (*Triticum aestivum* L.) from 06/08/2014 until 31/08/2015, were recorded and analysed. The maize was cultivated in a 3.3 ha field with winter wheat as the previous crop and mustard as a cover crop, while winter wheat was cultivated via direct sowing in a 1.6 ha field right after harvesting maize for silage. All tasks, which were performed by the farmer during this season, were recorded, including the use of each machine and the utilised inputs such as seeds, pesticides, fertilisers, etc. Furthermore, all the financial transactions that were related to the crop were recorded (e.g. fuel procurement, employee

Table 1
Recorded messages by the data logger.

Message	PGN	SPN	Description
LFC	FEE9	182	EngTripFuel
LFE1	FEF2	183	EngFuelRate
GBSD	FE49	1859	GroundBasedMachineSpeed
RHS	FE45	1873	RearHitchPosition

payrolls). To test the financial analysis, which is performed based only on the standard values, the farmer was asked to provide his own assessment on typical costs for each performed task in terms of machine and labour.

The level of automation regarding the acquisition and analysis of CAN-Bus data was assessed by acquiring data during tillage operation on 30/11/2016 using a mouldboard plough. In total four fields were ploughed as can be seen in Fig. 4. The route of the tractor, as was acquired by the DGNSS while travelling between these fields, is also illustrated.

3. Results and discussion

3.1. Software architecture

A Farm Financial Analysis (*ffa*) tool was developed that utilised FI technologies based on the FISpace³ platform. The information flow of the combined *ifarma-ffa* FMIS is presented in Fig. 5. At the core, the *ifarma-ffa* graphical user interface (GUI) widgets can be distinguished, where the user interaction also takes place. This was deployed in the FISpace B2B (business-to-business) platform (first level of automation) and the first and most important tool that it uses is the authentication/authorisation services. Using this GUI the user could import all data related to farming activities, but also the standard values (second level of automation). Through the *ifarma-ffa* service, the software could connect to the backend of the FMIS database or with third-party applications such as an external FMIS or/and open data databases (weather data, standard value database, etc.). To realise the third level of automation, an *ifarma* ISOBUS service was developed that was responsible for receiving the logged machine data. The ISOBUS web service was developed with SWI Prolog⁴ and was listening for requests on HTTP port (80). It was parsing the ASCII files using Prolog rules in a manner similar to DCG (Definite Clause Grammar) (Pereira and Warren, 1980).

A stand-alone application was developed using MATLAB and was installed at the remote cloud-based server. The ISOBUS service was calling the MATLAB App by passing the acquired ISOBUS data. Initially, in this App the data were filtered using the information from the rear hitch positions (SPN 1873) and the ground-based machine speed (SPN 1859), to extract only the in-field data from the complete dataset. Then, the MATLAB App was performing the k-means algorithm for defining separated fields (i.e. land parcels), and was returning to the service the data that corresponded to each field. The specific k-means function is using k-means++ algorithm for centroid initialization and squared Euclidean distance (Arthur and Vassilvitskii, 2007). This intermediate structure was then processed to generate task files in JSON format. The type of the task (fertilisation, transportation, etc.) was determined by the starting message depending on which switch was set to ON, while the other task properties such as duration and fuel consumption were calculated from the MATLAB App. The ISOBUS service generated the performed tasks with all related data and this information was forwarded to the *ifarma-ffa* service that was responsible for storing this information in the FMIS database and for presenting it to the user using the GUI.

3.2. 1st level of automation: A modular FMIS based on FISpace integration

The FISpace is a B2B collaboration platform, which among others preserves the links between companies and the rules and conditions for data sharing. In this work, the benefit for the user was the utilised authentication method, as data privacy is a very critical point in smart farming (Wolfert et al., 2017). Nevertheless, by utilising FISpace, the

³ www.fispace.eu.

⁴ www.swi-prolog.org.



Fig. 4. Satellite image of the area where the machine data were acquired during a ploughing operation. The route of the tractor is also indicated (green dots). (For interpretation of the references to colour in this figure legend, the reader is referred to the web version of this article.)

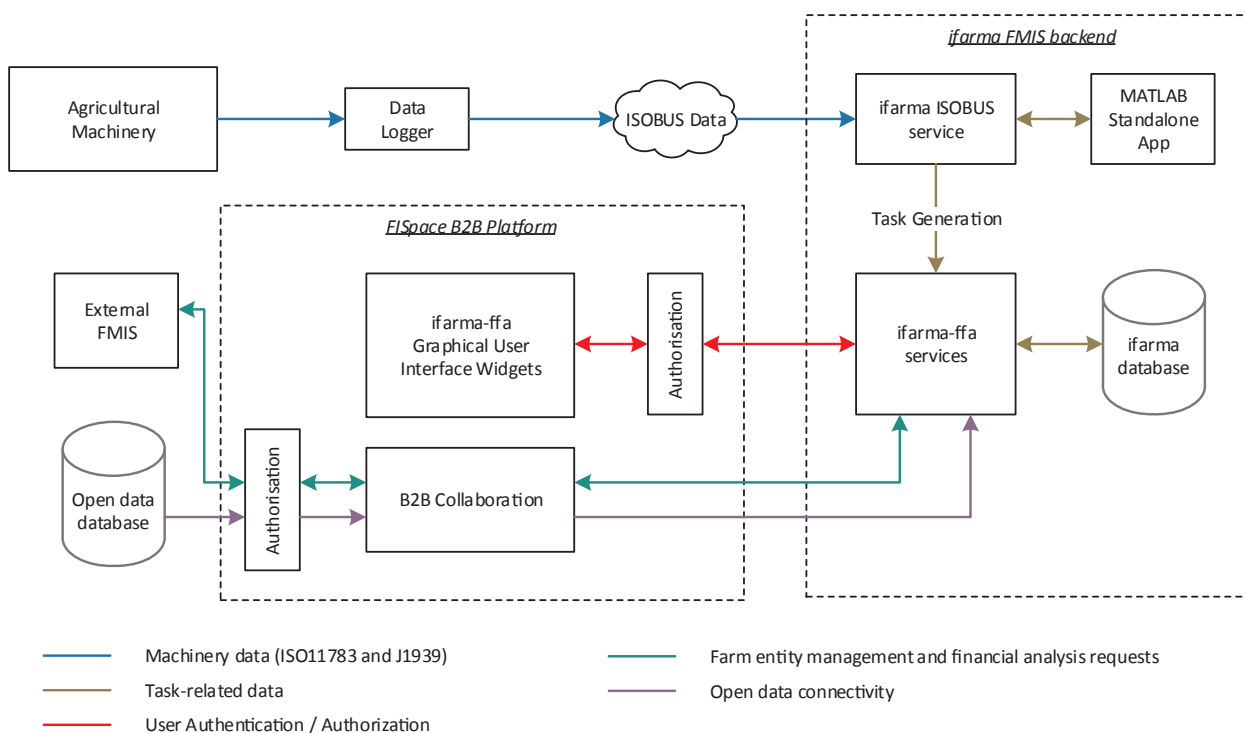

Fig. 5. Information flow of the ifarma-ffa FMIS.

FMIS becomes a part of a software ecosystem, which can be highly beneficial for the user by integrating in the future the desired GEs (e.g. GIS reporting, connecting sensors using IoT, etc.), thus increasing the level of automation of the FMIS.

The FISpace integration by the ffa was performed as follows:

- (1) Frontend components, as a set of Wirecloud GE⁵ widgets, provided an end-user interface enabling farmers/users to access and manage farm entities and perform farm financial analysis. The widgets were uploaded and installed in the Wirecloud instance of FISpace and are available to all authorised users of FISpace.
- (2) All FMIS backend services that implement the farm management and financial analysis services of ifarma-ffa backend module were implemented as a set of representational state transfer (REST) API

services. These services were then manifested FISpace capabilities, a feature of FISpace B2B collaboration module that provides an interoperability framework for orchestrating and executing complex business processes that consist of a set of interoperable services.

- (3) All access to FISpace was controlled by the platform's Identity and Access Management (IDM) component (KeyCloak) so that secure and authorised access is achieved.

An example of FISpace integration can be seen in Fig. 6. In this case, the ffa communicates with the backend of the ifarma FMIS through the System and Data Integration (SDI) component that is used for communication between front- and backend as well as exposing the backend APIs as FISpace capabilities. Initially, the ffa performs a farm entity management request to the SDI while the latter answers with a 204 http response meaning that the server has successfully fulfilled the request. Then, the SDI asks the ifarma backend about the specific entity

⁵ catalogue.fiware.org/enablers/application-mashup-wirecloud.

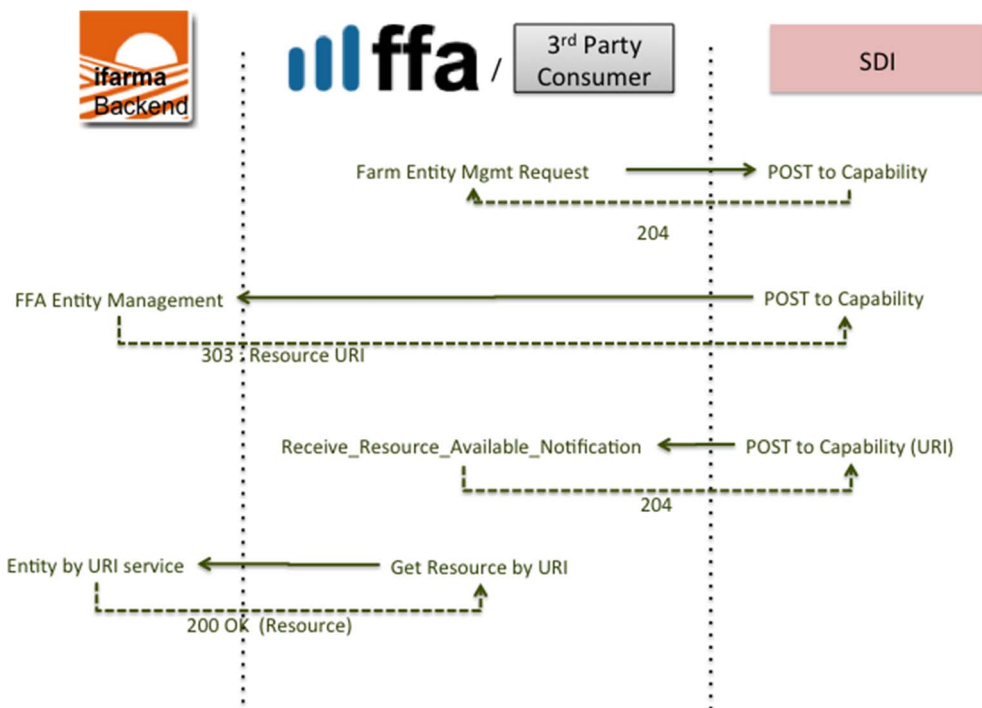

Fig. 6. An example of FISpace integration by the ifarma-ffa FMIS using the SDI component.

to get a 303 http response with the uniform resource identifier (URI) of the resource management resource. With this information, the SDI informs the ffa regarding the necessary URI. As the last step, the ffa asks the ifarma backend for the desired farm entity management. The process finishes with a successful response from the backend (200 http code), which also includes the requested information.

3.3. The developed GUI

The developed GUI of the ifarma-ffa FMIS is presented in Fig. 7. The ifarma-ffa frontend was developed as a set of interconnected widgets in the WireCloud GE. The first widget is Farms (up left side), which manages farms and financial seasons. The financial season is the time period for which the financial analysis is performed. The developed FMIS allowed the management of multiple farms for a user/farmer. The

The screenshot displays the 'Growthings - Tasks - Inputs' section of the application. It features a sidebar with 'Farms' and 'Tasks' lists. The main area shows 'Growthings of Uni Hohenheim Research Farm - Season 2014-2015' with a table of growthings and a detailed table of tasks for Maize.

Season	Field	Growing	Variety	Area (ha)	Actions
Season 2014-2015	Maize	Maize	PR 39 F 58	3.3	[X] [G] [M]
Season 2014-2015	Winter wheat	Wheat Pamier	Pamier	1.6	[X] [G] [M]

Task	Date	Area (ha)	Cost (€)	Inputs	Actions
Transport and distribution of manure using trailer @ Maize	2014-08-06	3.3	83	Foreign labour, Tractor	[X] [G] [M]
Harrowing by tractor @ Maize	2014-08-06	3.3	64	Harrow, Foreign labour	[X] [G] [M]
Transport and distribution of manure using trailer @ Maize	2014-08-12	3.3	187.5	Manure, Tractor, Foreign labour	[X] [G] [M]
Harrowing by tractor @ Maize	2014-08-15	3.3	64	Harrow, Foreign labour	[X] [G] [M]
Sowing with sowing machine @ Maize	2014-08-21	3.3	238.275	Seeding machine, Foreign labour, Seeds	[X] [G] [M]
Furrowing by tractor @ Maize	2014-11-28	3.3	108.5	Furrow plough, Foreign labour	[X] [G] [M]
Ripper usage @ Maize	2015-02-06	3.3	108.5	Ripper, Foreign labour	[X] [G] [M]
Multher usage @ Maize	2015-02-09	3.3	165	Multher, Foreign labour	[X] [G] [M]

Fig. 7. The developed GUI of the ifarma-ffa.

User Name	Farm ID	Crop ID	Task Group	Task ID	Input Type Group	Input Type ID	Values
User	0	Wheat	Plant Protection	0	0	0	Task: A. Unit cost in €/ha B. Efficiency (ha/hour)
User	0	Wheat	0	Pesticide Application	PPP	0	Input: A. Unit cost in €/kg B. Efficiency (ha/kg)

Fig. 8. An example of Standard Values functionality of the ifarma-ffa.

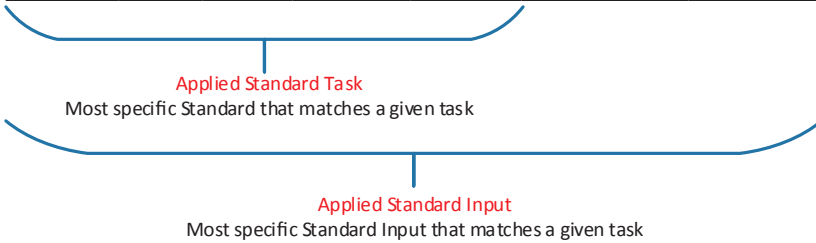

Growings - Tasks - Inputs								Standard Values	Costs	Analysis
Refresh										
Crop:								20 Items		
5 Any 15 Wheat Pamier										
Task Group:										
1 Any 6 Fertilization										
Task:										
1 Any 1 Combine harvesting										
Input Group:										
2 Fertilizer 7 Labor										
Farm	Crop	Task Group	Task	Input Group	Input	Unit	Cost (Euro/Unit)			
Any	Any	Field-Soil Preparation	Cultivator usage	Labor	Foreign labour	Ha	5			
Henrys Farm	Any	Seeding - Planting	Sowing with sowing machine	Machine	Seeding machine	Ha	9			
Henrys Farm	Any	Field-Soil Preparation	Cultivator usage	Machine	Cultivator	Ha	10			
Henrys Farm	Any	Spray	Any	Machine	Seeding machine	Ha	6			
Henrys Farm	Any	Field-Soil Preparation	Cultivator usage	Machine	Disk harrow	Ha	12			
Uni Hohenheim Research Farm	Wheat Pamier	Seeding - Planting	Direct Sowing	Machine	Direct Sowing machine	Ha	20.53			
Uni Hohenheim Research Farm	Wheat Pamier	Seeding - Planting	Direct Sowing	Labor	Foreign labour	Ha	20			

Fig. 9. The Standard Values widget of the ifarma-ffa.

Growings - Tasks - Inputs							Standard Values	Costs	Analysis
Refresh									
Seasons:							23 Items		
23 Season 2014-2015									
Search:									
Transactions:									
Season	Date	Ref.Number	Description	Entity	Amount (€)				
Season 2014-2015	2014-09-23		AZUBI		16				
Season 2014-2015	2015-03-05		Ruess and AZUBI		19.2 and 9.6				
Season 2014-2015	2015-08-01		Combine harvester		50				
Season 2014-2015	2015-03-12		fertilizer		176				
Season 2014-2015	2014-09-23		Fuel		120				
Season 2014-2015	2015-04-16		liquid fertilizer		86				

Fig. 10. The Costs widget of the ifarma-ffa.

widget *Growings* manages Fields (land parcels) and the crops that are cultivated in each field. The Fields belong to a Farm but a Growing (crop) refers to a specific farm and season. The Growings are presented in a table format, as a list or in a visual style format via the utilisation of Google Maps™ plugin. Finally, the widget *Tasks* (Farming activities) at the bottom is responsible for the management of farming tasks and their required inputs. Ifarma-ffa supports a large number of predefined farming tasks for all types of activities such as soil preparation, seeding and ploughing, irrigation, harvesting, fertilising, etc. Each of these predefined tasks is preloaded with the required inputs (machines, labour work, fertilisers, pesticides, etc.). The three other widget, i.e.

Standard Values, Costs, and Analysis, are described in the following sections.

3.4. 2nd level of automation: Financial analysis based on Standard Values

The ffa module uses standard value rules to determine the cost of farming activities when no values are registered by the user. These values pose a set of rules defining cost and efficiency of each input in every Task. The users imports these values and the system matches each farming task and inputs with the standard value rules. More specific rules have higher priority over less specific ones. The first match is used

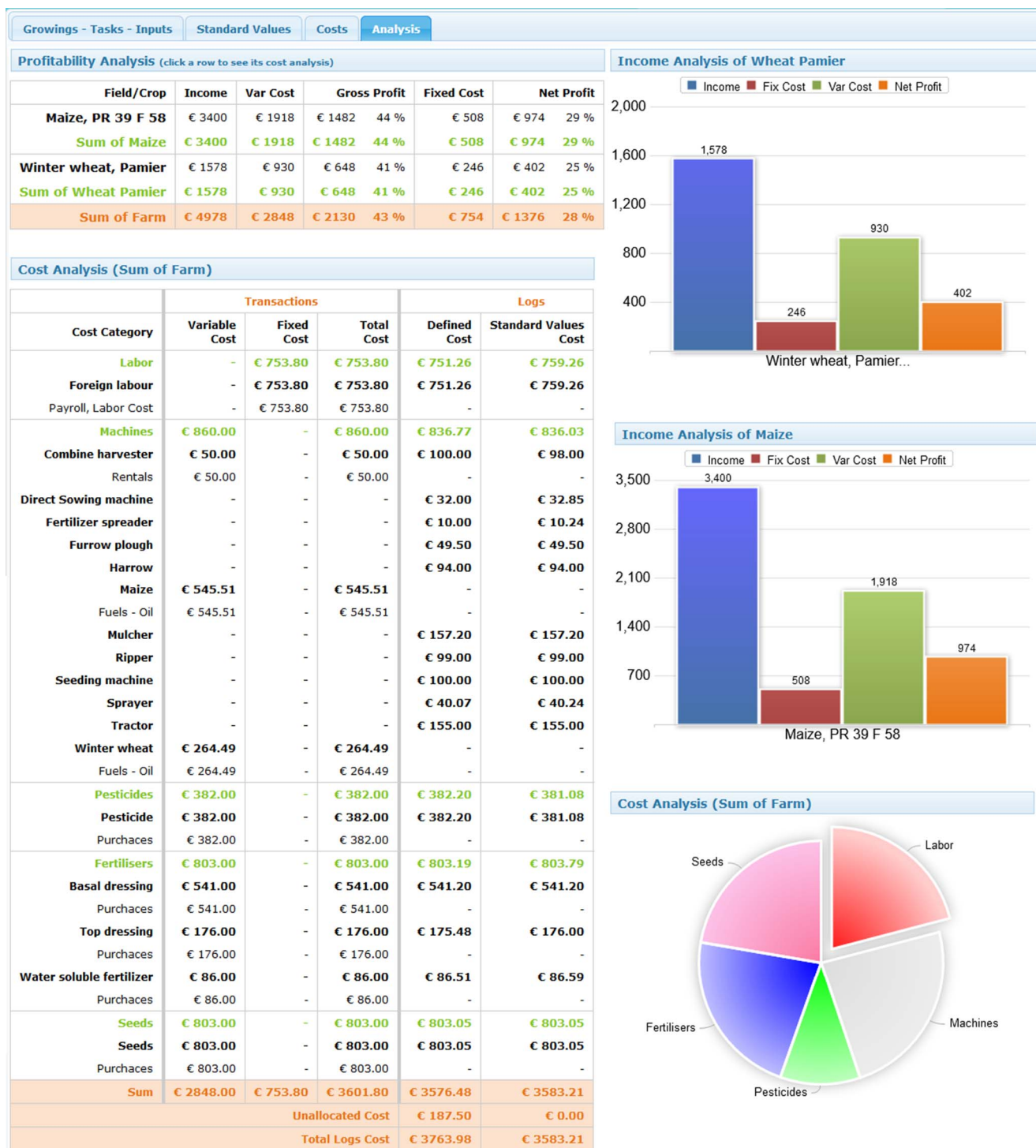

Fig. 11. Profitability analysis tab of the ifarma-ffa.

to determine the efficiency and cost to be used for a specified farming task. An example can be seen in Fig. 8 where two standard values are presented. The number 0 in the Farm ID indicates that the specific standard values apply to all fields of the specific User. Regarding the first rule, as soon as the system identifies a task related to plant protection for wheat for the specific user, it will apply the values to this task as these were given by the FMIS user in the Standard Values section (in this case Cost in €/ha and efficiency in ha/hour). The second rule will be applied to all farms and to all tasks with an input related to the specific product (PPP).

The Standard Values widget for the experimental data can be seen in

Fig. 9. The user can insert very specific standard values by providing all details (last line) or provide a standard value without specifying a category. An example of the latter case is the first line of the table in Fig. 9 where the value of 5 €/ha will be applied to every farm and every crop when a person is hired for field soil preparation using a cultivator.

3.5. Costs

The Costs widget enables recording of all financial transactions that are linked to a specific farm. A large number of transaction types are predefined in ifarma-ffa: product sales, expenses, goods purchases, land

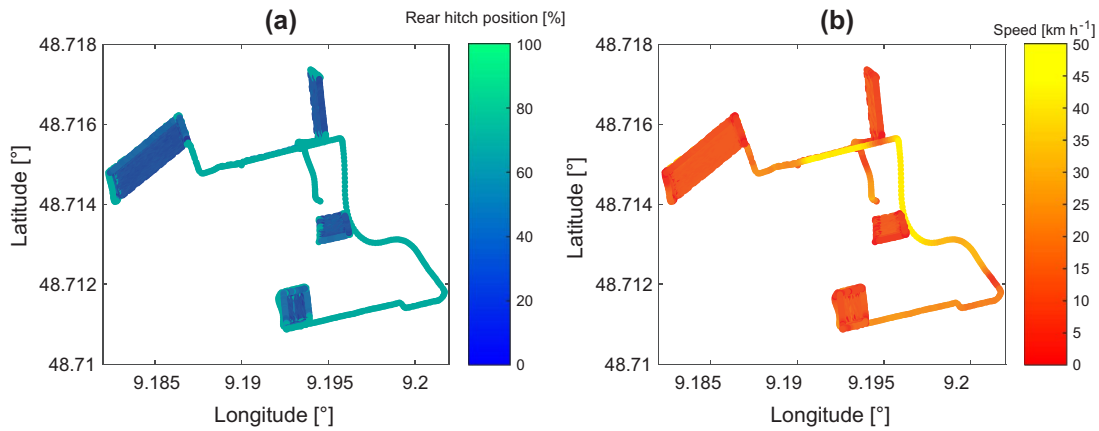

Fig. 12. (a) Rear hitch position and (b) speed of the tractor.

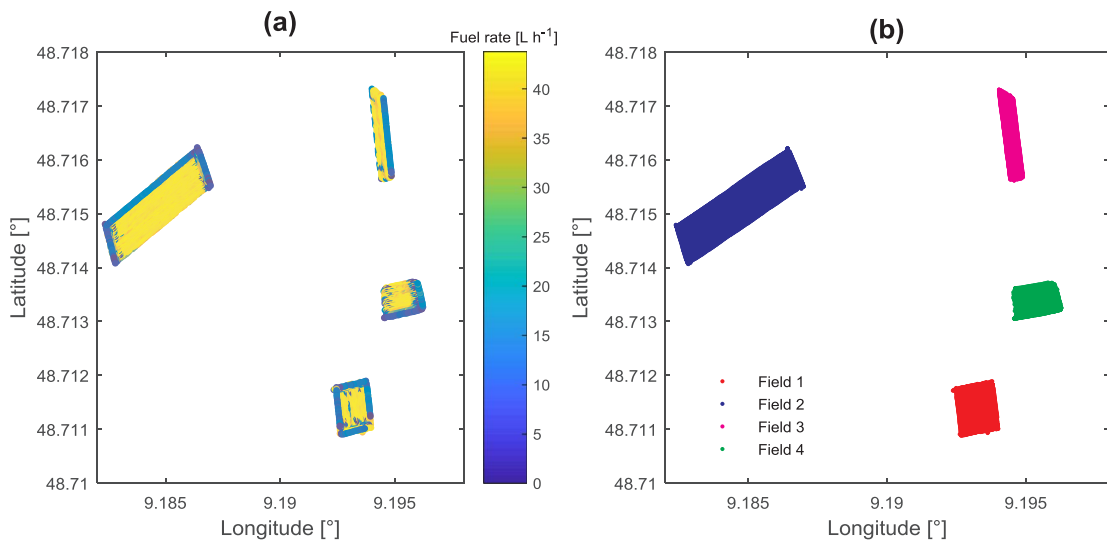

Fig. 13. (a) Fuel rate of the filtered data and (b) the four defined fields after k-means clustering.

Task	Date	Cost (€)	Inputs	Actions
Plowing by tractor @ Maize @ Meireihof Maize	2016-11-30	60	Tractor	✖

Fig. 14. The created task in the ifarma-ffa for Field 2.

rentals, fuel and maintenance, worker payments, machine value depreciation, etc. The amounts recorded in these transactions are used for the provided financial analyses. As an example, in Fig. 10, six transactions can be seen with the information regarding season, date, a short description and the related amount in Euros. These specific six transactions were performed during the season 2014–2015 and involve all fields that were cultivated in the selected farm.

3.6. Financial analysis

The financial analysis results performed by ifarma-ffa financial module for the winter wheat and maize are illustrated in Fig. 11. At the top left of Fig. 11, the Profitability Analysis table presents Income, Variable and Fixed cost per Field, Crop and Total farm. Gross and Net Profit are also calculated as an absolute and a percentage value. The results in this table are based on the transactions that were imported in the Costs tab (Fig. 10). It can be seen that the net profit for maize and wheat was 29% and 25% of the income, respectively, while the total net profit was 28%. In addition to the table Views, the analysis is also presented with the interactive graphs to the right of Fig. 11. On the top

right of Fig. 11, the graph shows the Income Profitability for winter wheat and in the middle graph for maize. On the bottom right, the Cost Analysis is presented as a pie graph.

In the Cost Analysis table of Fig. 11 right below the Profitability Analysis table, Cost is divided into predefined cost categories: Fertilisers, Labour, Machines, Pesticides, Seeds, Land, Irrigation and General expenses. For each Cost Category, the cost is further divided into individual Item types (e.g. Machine or Labour) and cost elements based on the transaction type. Depending on the cost category and element, under the Transactions column, the analysis shows the variable cost, which is directly assigned to the specific field or crop by the transactions in the Costs tab (Fig. 10), and fixed cost that is booked for the whole farm and later allocated to the fields or crops based on given allocation keys. As an example, it is visible that the fuel transactions for maize and wheat were € 545.51 and € 264.49, respectively.

In the Defined Costs of the Logs column, the costs that were imported as Inputs to the Tasks (inserted in the main GUI shown in Fig. 7) are presented. Furthermore, in the Standard Values Costs, the costs based only on the user's Standard Values can be seen. In this case, the financial analysis is not taking into consideration the Inputs of each

specific task but only the Standard Values that match each Task. The Cost Analysis matches, per item type, the cost registered in the financial transactions with the cost logged in the Farming Tasks. Based on this match the user can revise the unit cost of each item type. If the user has imported a task with a total cost, without specifying all inputs to this task, this amount appears here as unallocated cost (in this case is € 187.50). A slight difference can be observed comparing the Cost Sum of the three different evaluation methods (€ 3601.80, € 3763.98, and € 3583.21, for the cost analysis based on the transactions, defined costs from all imported tasks, and standard values, respectively).

3.7. 3rd level of automation: Task aggregation using machine data

The acquired rear hitch position (SPN 1873) and the speed of the tractor (SPN 1859) are presented in Fig. 12a and b, respectively. From Fig. 12a, it is evident that when the tractor was turning at the headlands or was travelling between different fields, the rear hitch position was at 100%. This meant that the hitch position was at the maximum top position. The high speed of the tractor reaching 50 km h^{-1} while travelling between the fields, compared to the speed for in-field ploughing, can be seen in Fig. 12b.

The engine fuel rate (SPN 183) of the filtered data set is presented in Fig. 13a. A maximum fuel rate while ploughing of around 45 L h^{-1} can be detected in Fig. 13a. The k-means algorithm was applied to the filtered dataset and the resulted four fields (clusters) can be seen in Fig. 13b. This information was passed to the ifarma ISOBUS service which then created a task for the specific field as can be seen in Fig. 14. The created Task indicated the type of work that was performed (i.e. ploughing), the date and the Cost. The cost was based on the time and the factor that was given as a standard value for the specific Task, which in this case was € 60 per hour for the involved tractor. In any other case, this field would have remained empty. The example presented in Fig. 14 is the result of the analysis of the data of Field 2 (Fig. 13b), which had a duration of 1 h. The aim was to create the task in the FMIS with a rough estimate of the cost since this is one of the most laborious tasks that usually the farmer is reluctant to perform. Later the farmer had the chance to edit Task Inputs by including more details.

4. Conclusions

Three levels for automating an FMIS were discussed and the architecture that implements these levels of automation was described. The FMIS was built on FI technologies, which can provide support on adding additional functionalities in the future with minimum effort. The developed application proved to be capable of performing a profitability analysis based on the recorded cost of transactions but also based on the information given by the user, which were related to the performed tasks. The use of standard values can be a useful solution when data are missing or are difficult to be calculated. Future work should include connecting the FMIS with an open data repository for acquiring standard values (e.g. KTBL in Germany - Kuratorium für Technik und Bauwesen in der Landwirtschaft).

Machine data from J1939 and ISO 11783 communication were collected, analysed, and aggregated into agricultural tasks. The developed methodology managed to reduce the manual data treatment for importing task-related data into the FMIS, a process which is error-prone and time-consuming. The FMIS presented the performed tasks to the user, giving the possibility to further process them. Furthermore, data that for the farmer was difficult to record, e.g. engine fuel rate, became available via the FMIS.

Although the three levels were categorised based on their involved complexity, the implementation does not necessarily require all of them or in that order. Only one or two automation levels can be implemented based on the specific farmer needs.

Future work should involve statistical approaches capable of

handling the large amount of information that is becoming available to the FMIS. Furthermore, more sophisticated analysis of ISOBUS data would help to extract more detailed information related to the performed tasks, such as cultivated area, time allocation at the headlands, idle time, etc. Finally, the developed FMIS should be expanded to support precision farming applications and adapt to the coming ISO standard for constant wireless in-field communication between machines and FMIS.

Acknowledgement

This work was funded by the ICT-AGRI ERA-Net project ifarma-ffa and was financially supported by the German Federal Ministry of Food and Agriculture (BMEL) through the Federal Office for Agriculture and Food (BLE), grant number 2815ERA01H. This project was also funded by SmartAgriFood (Smart Food and Agribusiness, Future Internet for Safe and Healthy Food from Farm to Fork) under the FI. ICT-2011.1.8 Work Programme.

References

- Amptatzidis, Y., Tan, L., Haley, R., Whiting, M.D., 2016. Cloud-based harvest management information system for hand-harvested specialty crops. *Comput. Electron. Agric.* 122, 161–167. <http://dx.doi.org/10.1016/j.compag.2016.01.032>.
- Arthur, D., Vassilvitskii, S., 2007. K-means++: The Advantages of Careful Seeding, in: *Proceedings of the Eighteenth Annual ACM-SIAM Symposium on Discrete Algorithms, SODA '07*. Society for Industrial and Applied Mathematics, Philadelphia, PA, USA, pp. 1027–1035.
- Blank, S., Bartolein, C., Meyer, A., Ostermeier, R., Rostanin, O., 2013. iGreen: a ubiquitous dynamic network to enable manufacturer independent data exchange in future precision farming. *Comput. Electron. Agric.* 98, 109–116. <http://dx.doi.org/10.1016/j.compag.2013.08.001>.
- Doyle, D., Jolly, R., Hornbaker, R., Cross, T., King, R.P., Koller, E.F., Lazarus, W.F., Yeboah, A., 2000. Case studies of farmers' use of information systems. *Rev. Agric. Econ.* 22, 566–585. <http://dx.doi.org/10.1111/1058-7195.00039>.
- Fountas, S., Carli, G., Sørensen, C.G., Tsiropoulos, Z., Cavalaris, C., Vatsanidou, A., Liakos, B., Canavari, M., Wiebensohn, J., Tisserye, B., 2015a. Farm management information systems: current situation and future perspectives. *Comput. Electron. Agric.* 115, 40–50. <http://dx.doi.org/10.1016/j.compag.2015.05.011>.
- Fountas, S., Sørensen, C.G., Tsiropoulos, Z., Cavalaris, C., Liakos, V., Gemtos, T., 2015b. Farm machinery management information system. *Comput. Electron. Agric.* 110, 131–138. <http://dx.doi.org/10.1016/j.compag.2014.11.011>.
- Husemann, C., Novković, N., 2014. Farm management information systems: a case study on a German multifunctional farm. *Econ. Agric.* 61.
- ISO, 2014. Tractors and machinery for agriculture and forestry - Serial control and communications data network - Part 10: Task controller and management information system data interchange. ISO/FDIS 11783-10:2014, International Organization for Standardization, Geneva, Switzerland.
- Kaivosoja, J., Jackenkroll, M., Linkolehto, R., Weis, M., Gerhards, R., 2014. Automatic control of farming operations based on spatial web services. *Comput. Electron. Agric.* 100, 110–115. <http://dx.doi.org/10.1016/j.compag.2013.11.003>.
- Kaloxylas, A., Eigenmann, R., Teye, F., Politopoulou, Z., Wolfert, S., Shrank, C., Dillinger, M., Lampropoulou, I., Antoniou, E., Pesonen, L., Nicole, H., Thomas, F., Alonistioti, N., Kormentzas, G., 2012. Farm management systems and the Future Internet era. *Comput. Electron. Agric.* 89, 130–144. <http://dx.doi.org/10.1016/j.compag.2012.09.002>.
- Kaloxylas, A., Groumas, A., Sarris, V., Katsikas, L., Magdalinos, P., Antoniou, E., Politopoulou, Z., Wolfert, S., Brewster, C., Eigenmann, R., Maestre Terol, C., 2014. A cloud-based farm management system: architecture and implementation. *Comput. Electron. Agric.* 100, 168–179. <http://dx.doi.org/10.1016/j.compag.2013.11.014>.
- Kortenbruck, D., Griepentrog, H.W., Paraforos, D.S., 2017. Machine operation profiles generated from ISO 11783 communication data. *Comput. Electron. Agric.* 140. <http://dx.doi.org/10.1016/j.compag.2017.05.039>.
- Lewis, T., 1998. Evolution of farm management information systems. *Comput. Electron. Agric.* 19, 233–248. [http://dx.doi.org/10.1016/S0168-1699\(97\)00040-9](http://dx.doi.org/10.1016/S0168-1699(97)00040-9).
- Nikkilä, R., Seilonen, I., Koskinen, K., 2010. Software architecture for farm management information systems in precision agriculture. *Comput. Electron. Agric.* 70, 328–336. <http://dx.doi.org/10.1016/j.compag.2009.08.013>.
- Oksanen, T., Piirainen, P., Seilonen, I., 2015. Remote access of ISO 11783 process data by using OPC Unified Architecture technology. *Comput. Electron. Agric.* 117, 141–148. <http://dx.doi.org/10.1016/j.compag.2015.08.002>.
- Paraforos, D.S., Vassiliadis, V., Kortenbruck, D., Stamkopoulos, K., Ziogas, V., Sapounas, A.A., Griepentrog, H.W., 2017. Automating the process of importing data into an FMIS using information from tractor's CAN-Bus communication. *Adv. Anim. Biosci.* 8, 650–655. <http://dx.doi.org/10.1017/S2040470017000395>.
- Paraforos, D.S., Vassiliadis, V., Kortenbruck, D., Stamkopoulos, K., Ziogas, V., Sapounas, A.A., Griepentrog, H.W., 2016. A farm management information system using future internet technologies. *IFAC-PapersOnLine* 49, 324–329. <http://dx.doi.org/10.1016/j.ifacol.2016.10.060>.

- Pereira, F.C.N., Warren, D.H.D., 1980. Definite clause grammars for language analysis—a survey of the formalism and a comparison with augmented transition networks. *Artif. Intell.* 13, 231–278. [http://dx.doi.org/10.1016/0004-3702\(80\)90003-X](http://dx.doi.org/10.1016/0004-3702(80)90003-X).
- Singh, M., Singh, P., Singh, B.S., 2008. Decision Support System for Farm Management. *World Acad. Sci. Eng. Technol. Int. J. Biol. Biomol. Agric. Food Biotechnol. Eng.* 39, 346–349.
- Sørensen, C.G., Pesonen, L., Bochtis, D.D., Vougioukas, S.G., Suomi, P., 2011. Functional requirements for a future farm management information system. *Comput. Electron. Agric.* 76, 266–276. <http://dx.doi.org/10.1016/j.compag.2011.02.005>.
- Steinberger, G., Rothmund, M., Auernhammer, H., 2009. Mobile farm equipment as a data source in an agricultural service architecture. *Comput. Electron. Agric.* 65, 238–246. <http://dx.doi.org/10.1016/j.compag.2008.10.005>.
- Tsiropoulos, Z., Fountas, S., Gemtos, T., Gravalos, I., Paraforos, D., 2013. Management information system for spatial analysis of tractor- implement draft forces, in: *Precision Agriculture 2013 - Papers Presented at the 9th European Conference on Precision Agriculture, ECPA 2013*.
- Verstegen, J.A.A.M., Huirne, R.B.M., Dijkhuizen, A.A., Kleijnen, J.P.C., 1995. Economic value of management information systems in agriculture: a review of evaluation approaches. *Comput. Electron. Agric.* 13, 273–288. [http://dx.doi.org/10.1016/0168-1699\(95\)00019-4](http://dx.doi.org/10.1016/0168-1699(95)00019-4).
- Wolfert, S., Ge, L., Verdouw, C., Bogaardt, M.-J., 2017. Big data in smart farming – a review. *Agric. Syst.* 153, 69–80. <http://dx.doi.org/10.1016/j.agsy.2017.01.023>.