

Design and simulation of fuzzy controller based (IPM) converter fed DC Motors

Abdallah A. Ahmed, Yuanqing Xia and Bo Liu

Abstract—This paper proposes a DSPF2812 based 32-bit micro-controller is used to generate PWM waveform required to switch IPM_DRIVE, by using fuzzy logic controller to control dc motor fed by AC/DC (IPM) converter. The fuzzy controller is designed in such a way that it can be implemented in a micro-controller or DSP processor based embedded system. The system designed consists of an inner ON/OFF current controller and an outer fuzzy speed controller. The fuzzy speed controller is used to change the duty cycle of the(IPM) converter and thereby, the voltage fed to the DC motor regulates its speed. The performance in respect of load variation and speed change has been reported. Simulations results are presented to demonstrate the proposed performance and then, compared with the reported results and found that the performance of fuzzy based IPM_DRIVE drive for DC motors is improved.

Index Terms—Fuzzy controller, DC motors, IPM_DRIVE converter, speed control.

I. INTRODUCTION

Since the first successful application of the fuzzy concept into the control of a dynamic plant several decades ago, there has been a considerable world wide interest in fuzzy controller. It has been known that it is possible to control many complex systems effectively by skilled operators who have no knowledge of their underlying dynamics, while it is difficult to achieve the same with conventional controllers [1][2]. They are used in several applications ranging from the control of power converters to speed control of motors [3]. It's suitable for applications such as the speed control of a dc motor which has nonlinearities. It is this fact which has ultimately made the fuzzy controller is more powerful to handle those un-modeled uncertainties. Meanwhile, the motion control applications can be found in almost every sector

of industry, from factory automation and robotics to high-tech computer hard disk drives. They are used to regulate mechanical motions in terms of position, velocity, acceleration and/or to coordinate the motions of multiple axes or machine parts. Furthermore, DC motors drives have been widely used in such applications where the accurate speed tracking is required, and in spite of the fact that AC motors are rugged, cheaper and lighter, DC motors are still a very popular choice in particular applications. It is known as a typical plant in the teaching on the control theory and research, and many methods have been developed for DC motors, for example, see [4], [5]-[10]. In conventional control strategies were used and it comprises of fixed arrangement with fixed parameter design. Hence the tuning and optimization of these controllers is a challenging and difficult task, particularly, under varying load conditions, parameter changes, abnormal modes of operation.

[11] has demonstrated and reported the separately excited dc motor fed by a chopper (DC to DC converter) and controlled by a fuzzy logic controller. It has been reported that the fuzzy logic controller controls the duty cycle of the chopper, there by the voltage fed to the motor for regulating the speed. The experimental setup has improved the performance over PI controller. It is seen that the separately excited dc drive have low starting torque which limits its applications.

H.A.Yousef and H.M.Khalil [12] have demonstrated the dc series motor drive fed by a single phase controlled rectifier (AC to DC converter) and controlled by fuzzy logic. It has been concluded that the fuzzy logic controller provides better control over the classical PI controller which has improved the performance. It is also reported that the settling time and maximum overshoot can be reduced. Due to the inherent limitations, AC to DC converter fed drive introduces unwanted harmonic ripples in the output.

Abdallah Ahmed and Yuanqing Xia are with the Department of Automatic Control, Beijing Institute of Technology, Beijing 100081, China. E-mail: abdouahmed12@gmail.com, xia_yuanqing@bit.edu.cn; Bo Liu is with the Systems Engineering Department, King Fahd University of Petroleum and Minerals, 31261 Dhahran, Saudi Arabia. E-mail: bo.liu.777@gmail.com

[13] has reported the dc series motor drive fed by a single phase full-bridge converter (DC to DC converter) controlled by fuzzy logic. It has been reported that the motor performance was simulated for different controllers like simplify fuzzy logic model (SFL), PI type fuzzy controller (FPI) and classical PI controller. The simulation result shows that the SFI provides superior performance over other controllers. It is found from the analysis that only the speed error has been taken as fuzzy input. There are some important achievements in fuzzy controller for closed loop control of DC drive (see, for example [14]-[20]).

The proposed system deals development of a speed for a dc motor fed by AC/DC (IPM) converter, utilizes the fuzzy logic controller and IPM_DRIVE (IPM power modules). The fuzzy logic based speed command is followed even under load torque disturbances.

The paper is structured as follows. Section II describes the mathematical model formulation of the proposed DC motors, while Section III presents the design of Fuzzy Logic Control . Section IV, gives a simulation results and discussion. Conclusion is given in Section V.

II. MATHEMATICAL MODEL OF DC MOTORS

The goal in the development of the mathematical model is to relate the voltage applied to the armature to the velocity or position of the motor. Two balance equations can be developed by considering the electrical and mechanical characteristics of the system. Because of the complexity of dynamic-system problems, idealizing assumptions will be made. These assumptions are:

Assumption 2.1: The brushes are narrow, and commutation is linear.

Assumption 2.2: The armature is assumed to have no effect on the total direct-axis flux because the armature-wave is perpendicular to the field axis.

Assumption 2.3: The effects of the magnetic saturation will be neglected [21].

The electric circuit of the armature and the free body diagram of the rotor are shown in Fig.1, where

- V_t - Motor terminal voltage
- R_a - Armature resistance
- L_a - Armature inductance
- J - Moment of inertia
- B -Friction coefficient
- T_l - Load torque

ω -Angular speed

θ -Angular displacement

K_T - Torque constant and

K_b - Back emf constant.

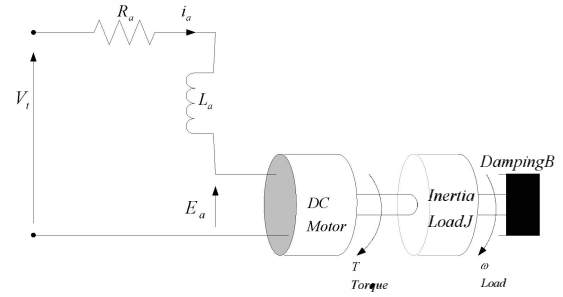

Fig. 1: DC Motor Equivalent Circuit.

By choosing i_a , ω and θ as the state variables and V_t as input. The output is chosen to be ω , and define the system matrices A_c , B_c and C_c as follows

$$A_c = \begin{bmatrix} \frac{-R_a}{L_a} & \frac{-K_b}{L_a} & 0 \\ \frac{K_T}{J} & \frac{-B}{J} & 0 \\ 0 & 1 & 0 \end{bmatrix}, \quad (1)$$

$$B_c = \begin{bmatrix} \frac{1}{L_a} \\ 0 \\ 0 \end{bmatrix}, \quad C_c = \begin{bmatrix} 0 & 1 & 0 \end{bmatrix}, \quad (2)$$

we have the following state space description of DC motors dynamic

$$\begin{cases} \dot{x}_t = A_c x_t + B_c u_t \\ y_t = C_c x_t \end{cases} \quad (3)$$

where state variables are

$$x = [i_a \ \omega \ \theta]^T \quad (4)$$

Sampling this system with step time T_s yields

$$\begin{cases} x_{k+1} = A x_k + B u_k \\ y_k = C x_k \end{cases} \quad (5)$$

where

$$A = e^{A_c T_s}, \quad B = \int_0^{T_s} e^{A_c(T_s-\tau)} B_c d\tau, \quad C = C_c \quad (6)$$

III. FUZZY LOGIC CONTROL (FLC)

Fig.2 shows the block diagram of the complete proposed system. The proposed system consists of DC motor,

IPM_DRIVE (IPM power modules) for driving the dc motor. A tacho generator(optical encoder) is used to measure the speed and which used for speed feedback. A DSPF2812 based 32-bit microcontroller is used to generate PWM waveform required to switch Intelligent Power Module (IPM), during the experimental setup. Firstly, Matlab/simlink model of the DC motor and the IPM_Drive power converter is developed and simulated, and then, fuzzy logic controller is designed by using fuzzy toolbox, finally, the closed loop operation is simulated.

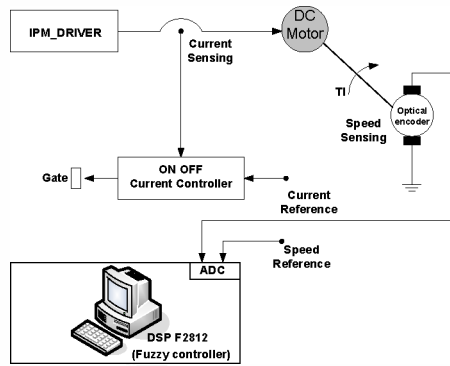

Fig. 2: Block diagram of proposed system.

Intelligent Power Module: Intelligent Power Module (IPM) is advanced hybrid power devices that combine high speed, low loss IGBTs with optimized gate drive and protection circuitry. System reliability is further enhanced by the IPM's integrated over temperature and under voltage lock out protection. Compact, automatically assembled Intelligent Power Modules are designed to reduce system size, cost, and time. In this paper, we use AC/DC converter based on Intelligent Power Module (IPM module, IRAM10UP60B-2) to driver DC motor, equivalent circuit of the IPM is shown in Fig.3.

The function of a fuzzy controller is to convert linguistic control rules based on expert knowledge into control strategy [23]. The effective and efficient control using fuzzy logic has emerged as a tool to deal with uncertain, imprecise or qualitative decision making problems [24]-[30]. The FLC consists of mainly four stages, namely Fuzzification, Rule-base, Inference engine and Defuzzification. The Takagi- Sugeno type controller is performed for present control for DC motor because it has singleton membership in the output variable. Moreover, it can be easily implemented and number of calculations can be

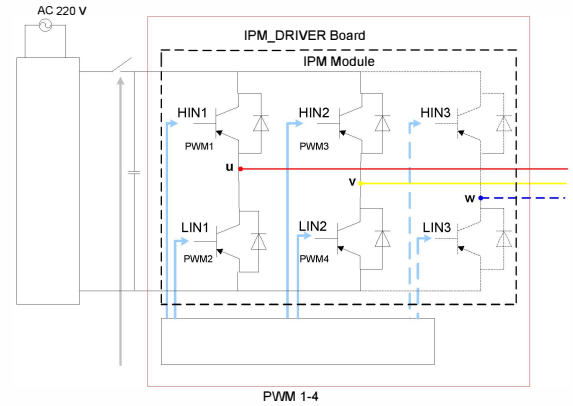

Fig. 3: Equivalent circuit of the IPM.

reduced and works well with optimization and adaptive techniques which makes it very attractive in control problems, particularly for dynamic nonlinear systems [31]. General structure of the fuzzy controller is shown in Fig. 4, and the simulink model developed is given in Fig.5.

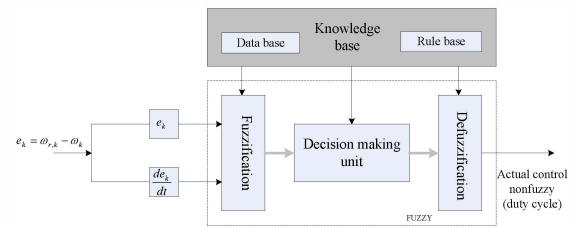

Fig. 4: General structure of the fuzzy controller .

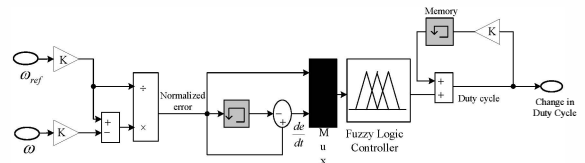

Fig. 5: Simulink scheme of the fuzzy controller.

A. Fuzzification

In this work, the motor variables considered are speed ω and current i_a . The speed ω is the control object of FLC. Let ω_r denote the reference speed, then the definitions for error e_k and change in error Δe_k are given in (7) and (8).

$$e_k = \omega_{r,k} - \omega_k \quad (7)$$

$$\Delta e_k = e_k - e_{k-1} \quad (8)$$

TABLE I: Rule based of the system

CE \ E	NB	NS	O	PS	PB
NB	NB	NB	NB	NS	Z
NS	NB	NB	NS	Z	PS
O	NB	NS	Z	PS	PS
PS	NS	Z	PS	PB	PB
PB	Z	PS	PB	PB	PB

Five linguistic variables are used for fuzzificating the input variable e_k and Δe_k as follows, Negative Big (NB), Negative Small (NS), Zero (Z), Positive Small (PS) and Positive Big (PB). In this work only five membership functions are used for the input, i.e. error and change in error. In order to reduce the number of membership function the width of the membership functions are kept different. The membership function width for the center membership functions is considered narrow and wide towards outer.

B. defuzzification

After fuzzy reasoning we have a linguistic output variable which needs to be translated into a crisp value. The objective is to derive a single crisp numeric value that best represents the inferred fuzzy values of the linguistic output variable. The linguistic variables are converted in to a numerical variable [32]. The defuzzified output is the duty cycle dc_k . The change in duty cycle Δdc_k can be obtained by adding the pervious duty cycle pdc_k with the duty cycle dc_k which is given in Eq.(9).

$$\Delta dc_k = dc_k + pdc_k \quad (9)$$

C. Rule table and Inference Engine

The Inference Mechanism provides the mechanism for invoking or referring to the rule base such that the appropriate rules are fired. The control rules related to the fuzzy output to the fuzzy inputs are derived from general knowledge of the system behavior, also the perception and experience. However, some of the control rules are developed using “trial and error” method [14]. The general rule can be written as “If $e(k)$ is X and $\Delta e(k)$ is Y then $\Delta dc(k)$ is Z ”, where X, Y and Z are the fuzzy variable for $e(k)$, $\Delta e(k)$ and $\Delta dc(k)$ respectively . The rule table for the designed fuzzy controller is given in the Table I [33].

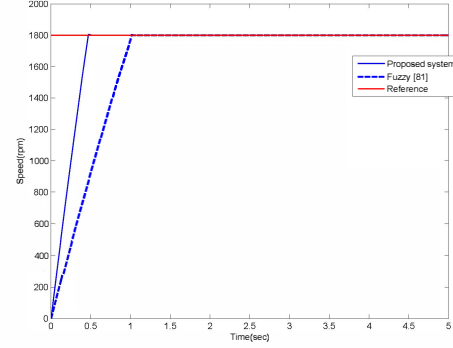

Fig. 6: Comparisons between the proposed system and fuzzy controller reference [34] for $\omega_r = 1800$ rpm .

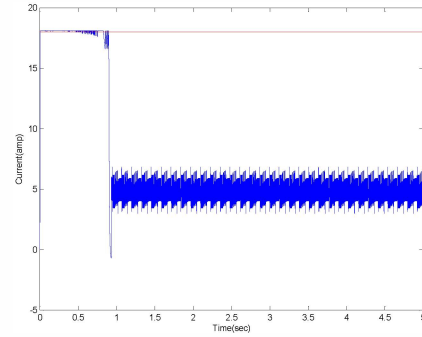

Fig. 7: Current variation with respect to time .

IV. SIMULATION AND DISCUSSION OF THE PROPOSED SYSTEM

In this section, the effectiveness of proposed model has been simulated using Matlab/simulink toolbox, the designed fuzzy controller (FC) and AC/DC converter based on Intelligent Power Module is tested. The simulation results of the proposed fuzzy controller(FC) are compared with fuzzy controller (FC) [34]. Fig.6 shows the comparisons between the proposed system fuzzy controller and fuzzy controller reference [34] for $\omega_r = 1800$ rpm , and Fig.7 is shown Current Variation respect to time. We can observed that, the current variation includes some harmonics due to AC to DC converter. In order to show the robustness of the proposed system, performance comparisons of the proposed system with reference [12] and reference [34] for the speed $\omega_r = 1800$ rpm is shown in the Table II.

The simulated result of speed regulation for a step change in load torque of 50% and 100% applied at $t = 2.5$ sec are shown in Fig. 8 and Fig. 9 respectively.

Form these figures, we can observed that the load

TABLE II: The performance comparisons of the proposed system with reference [12] and reference [34] .

Controller	[12]	[34]	current
Setting time	1.7 sec	1sec	0.7
Max.over shoot	3.2%	0.36%	0.30%

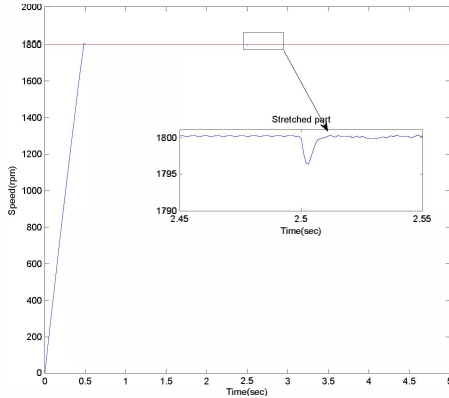

Fig. 8: Speed variation for the step change in load torque ($\Delta T_l = 50\%$) applied at $t = 2.5$ sec for $\omega_r = 1800$ rpm.

influences the performance of the controller. Furthermore, it is also observed that the motor speed is function of the load torque and it seen that when load is applied the motor takes it is sufficient time to reach the reference speed.

In order to validate the proposed method, the compared between proposed method and fuzzy controller (FC) [34] for speed $\omega_r = 1800$ rpm and load torque $\Delta T_l = 5N.m$ applied at time $t = 2.5sec$ is shown in Fig. 10. Furthermore, the comparison of the proposed system with reference [12] and reference [34] for the speed $\omega_r = 1800$ rpm and $\Delta T_l = 5N.m$ applied at $t = 2.5sec$ is shown in the Table III. Fig. 11 shown current variation for step

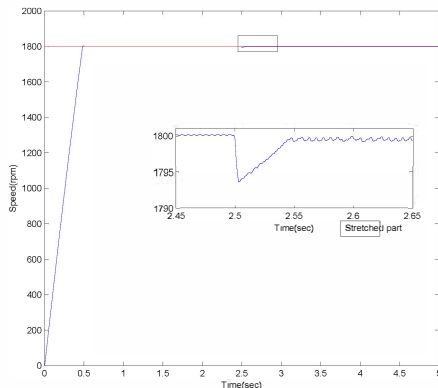

Fig. 9: Speed variation for the step change in load torque ($\Delta T_l = 100\%$) applied at $t = 2.5$ sec for $\omega_r = 1800$ rpm.

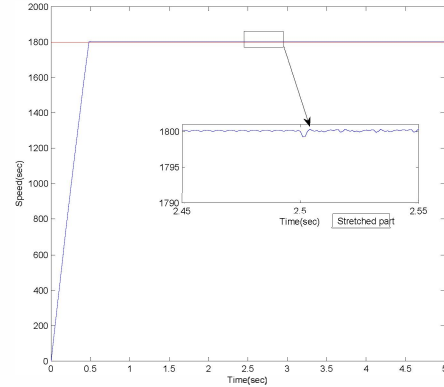

Fig. 10: Speed variation for the step change in load torque ($\Delta T_l = 5N.M$) applied at $t = 2.5$ sec for $\omega_r = 1800$ rpm.

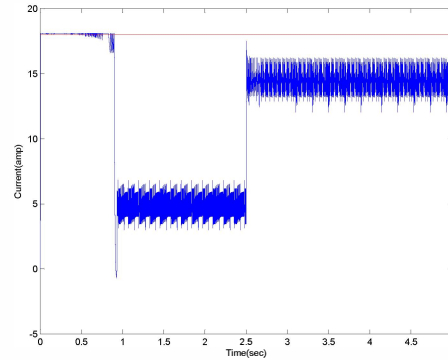

Fig. 11: Current variation for the step change in load torque ($\Delta T_l = 5N.m$) applied at $t = 2.5$ sec for $\omega_r = 1800$ rpm.

change in load torque ($\Delta T_l = 5N.M$) applied at $t = 2.5$ sec for $\omega_r = 1800$

V. CONCLUSION

This paper consider the fuzzy logic controller for control DC motor. In the proposed method, the mathematic model of DC motor is applied to evaluate the fuzzy logic controller, and a IPM_DRIVE (IPM power modules) is used to fed dc motor . The effective results show that the

TABLE III: Comparison of the proposed system with reference [12] and reference [34] speed $\omega_r = 1800$ rpm at $\Delta T_l = 5N.m$ applied at $t = 2.5sec$.

Controller	[12]	[34]	Current
Max.over shoot	3.2%	0.36%	0.30%
Max. speed drop	3.5%	0.36%	0.25%
Recovery time	2.4 sec	0.01 sec	0.007 sec

performance of DC motor controller has obtained better results by using Fuzzy Logic Controller and (IPM power modules) fed the proposed system. The designed fuzzy logic controller also is implemented in a micro-controller.

REFERENCES

- [1] J. Qiu, G. Feng, H. Gao, "Fuzzy-model-based piecewise H_∞ static output feedback controller design for networked nonlinear systems," IEEE Transaction on Fuzzy Systems, vol. 18, no. 5, pp. 919-934, Oct. 2010.
- [2] J. Qiu, G. Feng, H. Gao, "Asynchronous output feedback control of networked nonlinear systems with multiple packet dropouts: T-S fuzzy affine model based approach," IEEE Transaction on Fuzzy Systems, vol. 19, no. 6, pp. 1014-1030, Dec. 2011.
- [3] C.C. Lee, "Fuzzy logic in control system: Fuzzy Logic Controller- Part, I and II," IEEE Trans. on Systems Man and Cybernetics, Vol. 20, pp. 404 - 435, 1990.
- [4] Y. Kung and C. Liaw, "A fuzzy controller improving a linear model following controller for motor drives," IEEE Transactions on Fuzzy Systems, Vol. 2, no. 3, pp. 194-202, 1994.
- [5] Muhammad H. Rashid, Power electronics circuits, devices and applications, 2d edition, Prentice-Hall, 1993.
- [6] Philip T. Krein, Elements of power Electronics, Oxford University Press, 1998.
- [7] N.C. Jagan, Control System Second Edition, BS Publications 4-4-309, Giriraj Lane, Sultan Bazar, Hyderabad 2008.
- [8] Prof. Dr.-Ing. Dr. "h.c.", Control of Electrical Drives, Leonhard Technische University Braunschweig Institute for Regelungs technik published New York 1997.
- [9] S. Thompson, Control Systems Engineering and Design, Department of Mechanical and Manufacture Engineering, University of Belfast. UK Led 1989.
- [10] B. Chen, H. Uang and C. Tseng, "Robust tracking enhancement of robot systems including motor dynamics: a fuzzy-based dynamic game approach," IEEE Transactions on Fuzzy Systems, Vol. 6, no. 4, pp. 538-552, 1998.
- [11] N. Senthil Kumar, V. Sadasivam, K. Prema, "Design and simulation of fuzzy controller for closed loop control of chopper fed embedded dc drives," IEEE international conference, POWERCON, Singapore, 2004.
- [12] H.A. Yousef and H.M. Khalil "A fuzzy logic-based control of series DC motor drives," Proceedings of the IEEE International Symposium on Vol. 2, Issue 10-14, pp. 517 C 522, Jul 1995.
- [13] H.L. Tan "A simplified fuzzy logic controller for DC series motor with Improve performance," IEEE International Conference on Fuzzy System, Pp. 1523-1526, 2001.
- [14] T. Gupta and R. Boudreax, "Implementation of a Fuzzy Controller for DC-DC Converters Using an Inexpensive 8-Bit micro controller," IEEE Trans. on Industrial Electronics, vol. 44, no. 5, pp. 661-667, October 1997.
- [15] G. Uma and C. Chellamuthu, "Design and implementation of fuzzy logic control speed control system for a converter fed DC drive using 8097 micro controller," ISIE, Mexico 2000.
- [16] Soliman. H. F, Mansour. M. M, Kandil. S. A, and Sharaf. A. M, "A robust tunable fuzzy logic control scheme for speed regulation of DC series motor drives," Electrical and Computer Engineering, Canadian Conference, Vol. 1, Issue 5-8, pp. 296 C 299, Sep 1995. Y.F.
- [17] Li and C.C. Lau, "Development of fuzzy algorithms for servo system," IEEE Control System Magazine, April, 1989, pp 65-11.
- [18] Hung and Ching Lu, "Design and implemetation of a digitalized fuzzy controller for dc sero drives", IEEE International Conference on Intelligent Processing systems ,China October 1997.
- [19] Y. Tipsuwan and M. Y. Chow, "Fuzzy logic microcontroller implementation for DC motor speed control," in IEEE IECON'99, San Jose, CA, 1999.
- [20] Adel E. El-kholy and A. M. Dabroom, "Adaptive Fuzzy Logic Controllers for DC Drives: A Survey of the State of the art," Journal of Electrical Systems, pp. 116-145, 2006.
- [21] A.E. Fitzgerald and Charles kingsley, JR. Alexander KUSKO "Electric machinery" Third Edition United State of America. 1971.
- [22] Y. F. Li, and C. C. Lau, " Development of fuzzy algorithms for servo systems," IEEE Control Systems Mag., vo1.9, no.3, pp.65-72, Apr. 1989.
- [23] B. S. Zhang, and J. M. Edmunds, "On fuzzy logic controllers," IEE International Conference on Control, pp.961-965, Edinburg, U. K., 1991.
- [24] H. F. Soliman, M. M. Mansour, S. A. Kandil, and A. M. Sharaf, "A robust tunable fuzzy logic control scheme for speed regulation of DC series motor drives," Electrical and Computer Engineering, Canadian Conference, Vol. 1, Issue 5-8, pp. 296-299, Sep 1995.
- [25] G. Acciani, G. Fornarelli, and A. Giaquinto, "A fuzzy method for global quality index evaluation of solder joints in surface mount technology," IEEE Transaction on Industrial Informtics, vol. 7, no. 1, pp. 115-124, Feb. 2011.
- [26] K. Rajani, Mudi, and R. Pal Nikhil, Member, "A Robust Self-Tuning Scheme for PI- and PD-Type Fuzzy Controllers," IEEE Transactions On Fuzzy Systems, vol. 7, no. 1, pp. 2-16, Feb. 1999.
- [27] H. L. Tan, N. A. Rahim, and W. P. Hew, "A dynamic input membership scheme for a fuzzy logic DC motor controller," IEEE International Conference on Fuzzy Systems vol. 1, Issue 25-28, pp. 426-429 May 2003.
- [28] Young Im Cho, "Development of a new neuro-fuzzy hybrid system," Industrial Electronics Society, IECON, 30th Annual Conference of IEEE vol. 3, pp. 3184-3189, 2004.
- [29] Ping-Zong Lin, Chun-Fei Hsu and Tsu-Tian Lee, "Type -2 Fuzzy Logic Controller design for Buck DC-Dc converters," Proceedings of the IEEE International Conference on Fuzzy systems, pp. 365- 370, 2005.
- [30] Jabri Majed, Chouiref Houada, Jerbi Housseem, Benhadj Braiek and Naceur, "Fuzzy logic parameter estimation of an electrical system," Systems, Signals and Devices, IEEE SSD, 5th International Multi-Conference, pp. 1-6, 2008.
- [31] L. A. Zadeh, "Fuzzy sets," Information and Control, Vol. 8, pp. 338-352, 1965.
- [32] L. A. Zadeh, "Fuzzy algorithms," Info. and Ctl., Vol. 12, pp. 94-102, 1968.
- [33] N. Senthil Kumar, V. Sadasivam and M. Muruganandam, "A Low-cost Four-quadrant Chopper-fed Embedded DC Drive Using Fuzzy Controller," Inter National Journal of Electric Power Components and Systems, Vol. 35, Issue 8, pp. 907-920, August 2007.
- [34] M. Muruganandam and M. Madheswaran, "Modeling and Simulation of Modified Fuzzy Logic Controller for Various types of DC motor Drives," IEEE International Conference on Control, Automaiom, Communication and Energy conservation, June 2009.