

Piled raft foundations: design and applications

H. G. POULOS*

In situations where a raft foundation alone does not satisfy the design requirements, it may be possible to enhance the performance of the raft by the addition of piles. The use of a limited number of piles, strategically located, may improve both the ultimate load capacity and the settlement and differential settlement performance of the raft. This paper discusses the philosophy of using piles as settlement reducers and the conditions under which such an approach may be successful. Some of the characteristics of piled raft behaviour are described. The design process for a piled raft can be considered as a three-stage process. The first is a preliminary stage in which the effects of the number of piles on load capacity and settlement are assessed via an approximate analysis. The second is a more detailed examination to assess where piles are required and to obtain some indication of the piling requirements. The third is a detailed design phase in which a more refined analysis is employed to confirm the optimum number and location of the piles, and to obtain essential information for the structural design of the foundation system. The selection of design geotechnical parameters is an essential component of both design stages, and some of the procedures for estimating the necessary parameters are described. Some typical applications of piled rafts are described, including comparisons between computed and measured foundation behaviour.

KEYWORDS: numerical modelling and analysis; design; foundations; piles; soil/structure interaction; rafts; settlement.

Dans les situations où les fondations à radier ne suffisent pas à elles seules pour remplir les critères de construction, il est possible d'améliorer les performances du radier en ajoutant des piles. En utilisant un nombre limité de piles placées à des endroits stratégiques, on peut améliorer la capacité porteuse ultime et le tassement ainsi que la performance de tassement différentiel du radier. Cet exposé se penche sur l'utilisation de piles pour réduire le tassement et étudie les conditions dans lesquelles cette méthode peut réussir. Nous décrivons certaines des caractéristiques du comportement d'un radier à piles. Le processus de conception pour un radier à pile peut être considéré comme comportant trois étapes. La première est une étape préliminaire pendant laquelle les effets du nombre de piles sur la capacité porteuse et le tassement sont évalués au moyen d'une analyse approximative. La seconde étape consiste en un examen plus détaillé visant à évaluer l'endroit où les piles seront nécessaires et à obtenir une indication sur les critères nécessaires. La troisième est une phase de conception détaillée au cours de laquelle on emploie une analyse plus raffinée pour confirmer le nombre et l'emplacement optimum des piles et pour obtenir une information essentielle à la conception structurale du système d'assise. La sélection des paramètres géotechniques nominaux est une composante essentielle dans les deux étapes de conception et nous décrivons certaines des procédures permettant d'évaluer les paramètres nécessaires. Nous décrivons certaines applications types des radiers d'assise et faisons des comparaisons entre le comportement calculé et mesuré des fondations.

INTRODUCTION

It is common in foundation design to consider first the use of a shallow foundation system, such as a raft, to support a structure, and then if this is not adequate, to design a fully piled foundation in which the entire design loads are resisted by the piles. Despite such design assumptions, it is common for a raft to be part of the foundation system (e.g. because of the need to provide a basement below the structure). In the past few years, there has been an increasing recognition that the use of piles to reduce raft settlements and differential settlements can lead to considerable economy without compromising the safety and performance of the foundation. Such a foundation makes use of both the raft and the piles, and is referred to here as a pile-enhanced raft or a piled raft. One of the Technical Committees of the International Society for Soil Mechanics and Foundation Engineering (ISSMFE) focussed its efforts in the period 1994–7 towards piled raft foundations, collected considerable information on case histories and methods of analysis and design, and produced comprehensive reports on these activities (O'Neill *et al.*, 1996; van Impe & Lungu, 1996). In addition, an independent treatise on numerical modelling of piled rafts has been presented by El-Mossallamy & Franke (1997). Despite this recent activity, the concept of piled raft foundations is by no means new, and has been described by several authors, including Zeevaert (1957), Davis & Poulos (1972), Hooper (1973), Burland *et al.* (1977), Sommer *et al.* (1985), Price & Wardell (1986) and Franke (1991), among many others.

Manuscript received 2 May 2000; manuscript accepted 10 October 2000.

Discussion on this paper closes 6 September 2001, for further details see inside front cover.

* Coffey Geosciences Pty Ltd; University of Sydney, Australia

This paper describes the philosophy of design of pile-enhanced rafts, and outlines circumstances that are favourable for such a foundation. A three-stage design process is proposed, the first being an approximate preliminary stage to assess feasibility, the second to assess the locations where the piles are required, and the third to obtain detailed design information. Methods of analysis are described and compared, and some of the key characteristics of piled raft behaviour are described. The assessment of the required geotechnical parameters is then outlined, and finally a number of applications of piled raft foundations are presented.

DESIGN CONCEPTS

Design issues

As with any foundation system, the design of a piled raft foundation requires the consideration of a number of issues, including:

- (a) ultimate load capacity for vertical, lateral and moment loadings
- (b) maximum settlement
- (c) differential settlement
- (d) raft moments and shears for the structural design of the raft
- (e) pile loads and moments, for the structural design of the piles.

In much of the available literature, emphasis has been placed on the bearing capacity and settlement under vertical loads. While this is a critical aspect, and is considered in detail herein, the other issues must also be addressed. In some cases, the pile requirements may be governed by the overturning moments applied by wind loading, rather than the vertical dead and live loads.

Alternative design philosophies

Randolph (1994) has defined clearly three different design philosophies with respect to piled rafts:

- the 'conventional approach', in which the piles are designed as a group to carry the major part of the load, while making some allowance for the contribution of the raft, primarily to ultimate load capacity
- 'creep piling', in which the piles are designed to operate at a working load at which significant creep starts to occur, typically 70–80% of the ultimate load capacity; sufficient piles are included to reduce the net contact pressure between the raft and the soil to below the preconsolidation pressure of the soil.
- differential settlement control, in which the piles are located strategically in order to reduce the differential settlements, rather than to reduce the overall average settlement substantially.

In addition, there is a more extreme version of creep piling, in which the full load capacity of the piles is utilised: that is, some or all of the piles operate at 100% of their ultimate load capacity. This gives rise to the concept of using piles primarily as settlement reducers, while recognising that they also contribute to increasing the ultimate load capacity of the entire foundation system.

Clearly, the latter three approaches are most conducive to economical foundation design, and will be given special attention herein. However, the design methods to be discussed allow any of the above design philosophies to be implemented.

Figure 1 illustrates, conceptually, the load–settlement behaviour of piled rafts designed according to the first two strategies. Curve 0 shows the behaviour of the raft alone, which in this case settles excessively at the design load. Curve 1 represents the conventional design philosophy, for which the behaviour of the pile–raft system is governed by the pile group behaviour, and which may be largely linear at the design load. In this case, the piles take the great majority of the load. Curve 2 represents the case of creep piling, where the piles operate at a lower factor of safety but, because there are fewer piles, the raft carries more load than for curve 1. Curve 3 illustrates the

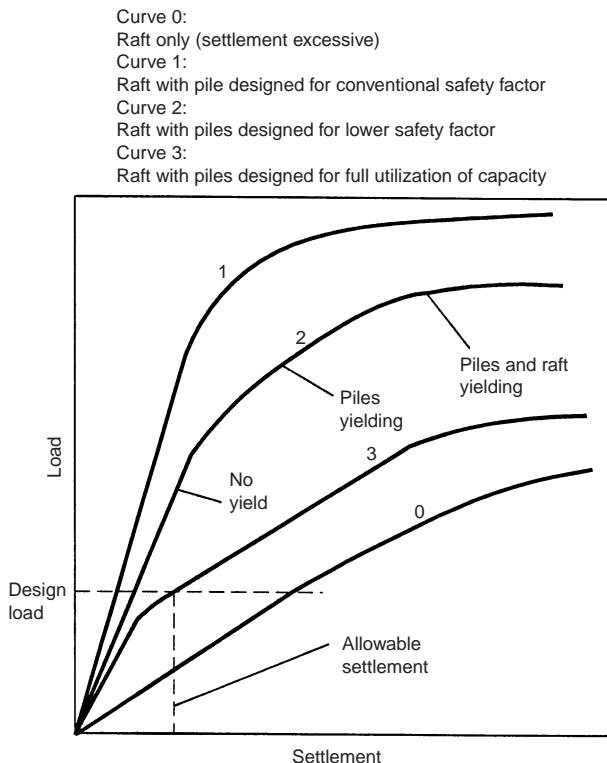

Fig. 1. Load–settlement curves for piled rafts according to various design philosophies

strategy of using the piles as settlement reducers, and utilising the full capacity of the piles at the design load. Consequently, the load–settlement may be non-linear at the design load, but nevertheless the overall foundation system has an adequate margin of safety, and the settlement criterion is satisfied. Therefore the design depicted by curve 3 is acceptable, and is likely to be considerably more economical than the designs depicted by curves 1 and 2.

Favourable and unfavourable circumstances for piled rafts

The most effective application of piled rafts occurs when the raft can provide adequate load capacity, but the settlement and/or differential settlements of the raft alone exceed the allowable values. Poulos (1991) has examined a number of idealised soil profiles, and has found that the following situations may be favourable:

- soil profiles consisting of relatively stiff clays
- soil profiles consisting of relatively dense sands.

In both circumstances, the raft can provide a significant proportion of the required load capacity and stiffness, with the piles acting to 'boost' the performance of the foundation, rather than providing the major means of support.

Conversely, there are some situations that are unfavourable, including:

- soil profiles containing soft clays near the surface
- soil profiles containing loose sands near the surface
- soil profiles that contain soft compressible layers at relatively shallow depths
- soil profiles that are likely to undergo consolidation settlements
- soil profiles that are likely to undergo swelling movements due to external causes.

In the first two cases, the raft may not be able to provide significant load capacity and stiffness, while in the third case, long-term settlement of the compressible underlying layers may reduce the contribution of the raft to the long-term stiffness of the foundation. The latter two cases should be treated with considerable caution. Consolidation settlements (such as those due to dewatering or shrinking of an active clay soil) may result in a loss of contact between the raft and the soil, thus increasing the load on the piles, and leading to increased settlement of the foundation system. In the case of swelling soils, substantial additional tensile forces may be induced in the piles because of the action of the swelling soil on the raft. Theoretical studies of these latter situations have been described by Poulos (1993) and Sinha & Poulos (1999).

THE DESIGN PROCESS

It is suggested that a rational design process for piled rafts involves three main stages:

- a preliminary stage to assess the feasibility of using a piled raft, and the required number of piles to satisfy design requirements
- a second stage to assess where piles are required and the general characteristics of the piles
- a final detailed design stage to obtain the optimum number, location and configuration of the piles, and to compute the detailed distributions of settlement, bending moment and shear in the raft, and the pile loads and moments.

The first and second stages involve relatively simple calculations, which can usually be performed without a complex computer program. The detailed stage will generally demand the use of a suitable computer program that accounts in a rational manner for the interaction among the soil, raft and piles. The effect of the superstructure may also need to be considered.

Preliminary design stage

In the preliminary stage, it is necessary first to assess the performance of a raft foundation without piles. Estimates of vertical and lateral bearing capacity, settlement and differential settlement may be made via conventional techniques. If the raft alone provides only a small proportion of the required load capacity, then it is likely that the foundation will need to be designed with the conventional philosophy, so that the function of the raft is merely to reduce the piling requirements slightly. If, however, the raft alone has adequate or nearly adequate load capacity, but does not satisfy the settlement or differential settlement criteria, then it may be feasible to consider the use of piles as settlement reducers, or to adopt the ‘creep piling’ approach.

For assessing vertical bearing capacity, the ultimate load capacity can generally be taken as the lesser of the following two values:

- (a) the sum of the ultimate capacities of the raft plus all the piles
- (b) the ultimate capacity of a block containing the piles and the raft, plus that of the portion of the raft outside the periphery of the piles.

For estimating the load–settlement behaviour, an approach similar to that described by Poulos & Davis (1980) can be adopted. However, a useful extension to this method can be made by using the simple method of estimating the load sharing between the raft and the piles, as outlined by Randolph (1994). The definition of the pile problem considered by Randolph is shown in Fig. 2. Using his approach, the stiffness of the piled raft foundation can be estimated as follows:

$$K_{pr} = \frac{K_p + K_r(1 - \alpha_{cp})}{1 - \alpha_{cp}^2 K_r K_p} \quad (1)$$

where K_{pr} = stiffness of piled raft; K_p = stiffness of the pile group; K_r = stiffness of the raft alone; and α_{cp} = raft–pile interaction factor.

The raft stiffness, K_r , can be estimated via elastic theory, for example using the solutions of Fraser & Wardle (1976) or Mayne & Poulos (1999). The pile group stiffness can also be estimated from elastic theory, using approaches such as those described by Poulos & Davis (1980), Fleming *et al.* (1992) or Poulos (1989). In the latter cases, the single pile stiffness is computed from elastic theory, and then multiplied by a group stiffness efficiency factor, which is estimated approximately from elastic solutions.

The proportion of the total applied load carried by the raft is

$$\frac{P_r}{P_t} = \frac{K_r(1 - \alpha_{cp})}{K_p + K_r(1 - \alpha_{cp})} = X \quad (2)$$

where P_r = load carried by the raft; P_t = total applied load.

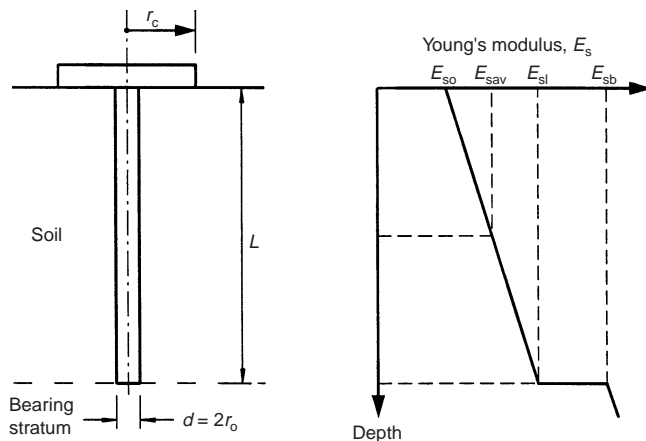

Fig. 2. Simplified representation of pile–raft unit

The raft–pile interaction factor, α_{cp} , can be estimated as follows:

$$\alpha_{cp} = 1 - \frac{\ln(r_c/r_0)}{\zeta} \quad (3)$$

where r_c = average radius of pile cap (corresponding to an area equal to the raft area divided by number of piles); r_0 = radius of pile; $\zeta = \ln(r_m/r_0)$; $r_m = \{0.25 + \xi[2.5\rho(1 - \nu) - 0.25]\} \times L$; $\xi = E_{sl}/E_{sb}$; $\rho = E_{sav}/E_{sl}$; ν = Poisson’s ratio of soil; L = pile length; E_{sl} = soil Young’s modulus at level of pile tip; E_{sb} = soil Young’s modulus of bearing stratum below pile tip; and E_{sav} = average soil Young’s modulus along pile shaft.

The above equations can be used to develop a tri-linear load–settlement curve, as shown in Fig. 3. First, the stiffness of the piled raft is computed from equation (1) for the number of piles being considered. This stiffness will remain operative until the pile capacity is fully mobilised. Making the simplifying assumption that the pile load mobilisation occurs simultaneously, the total applied load, P_1 , at which the pile capacity is reached is given by

$$P_1 = \frac{P_{up}}{1 - X} \quad (4)$$

where P_{up} = ultimate load capacity of the piles in the group; and X = proportion of load carried by the piles (equation (2)). Beyond that point (point A in Fig. 3), the stiffness of the foundation system is that of the raft alone (K_r), and this holds until the ultimate load capacity of the piled raft foundation system is reached (point B in Fig. 3). At that stage, the load–settlement relationship becomes horizontal.

The load–settlement curves for a raft with various numbers of piles can be computed with the aid of a computer spreadsheet or a mathematical program such as MATHCAD. In this way, it is simple to compute the relationship between the number of piles and the average settlement of the foundation. Figure 4 shows the results of a typical set of calculations of both settlement and factor of safety with respect to vertical bearing capacity as a function of the number of piles. Such calculations provide a rapid means of assessing whether the design philosophies for creep piling or full pile capacity utilisation are likely to be feasible.

Second stage of design: assessment of piling requirements

Much of the existing literature does not consider the detailed pattern of loading applied to the foundation, but assumes uniformly distributed loading over the raft area. While this may be adequate for the preliminary stage described above, it is not adequate for considering in more detail where the piles should

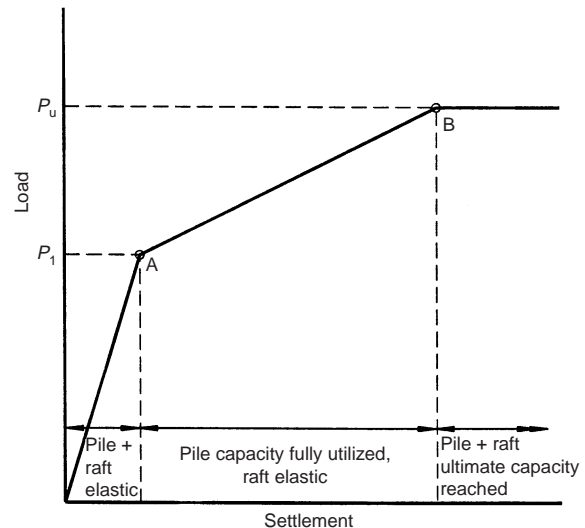

Fig. 3. Simplified load–settlement curve for preliminary analysis

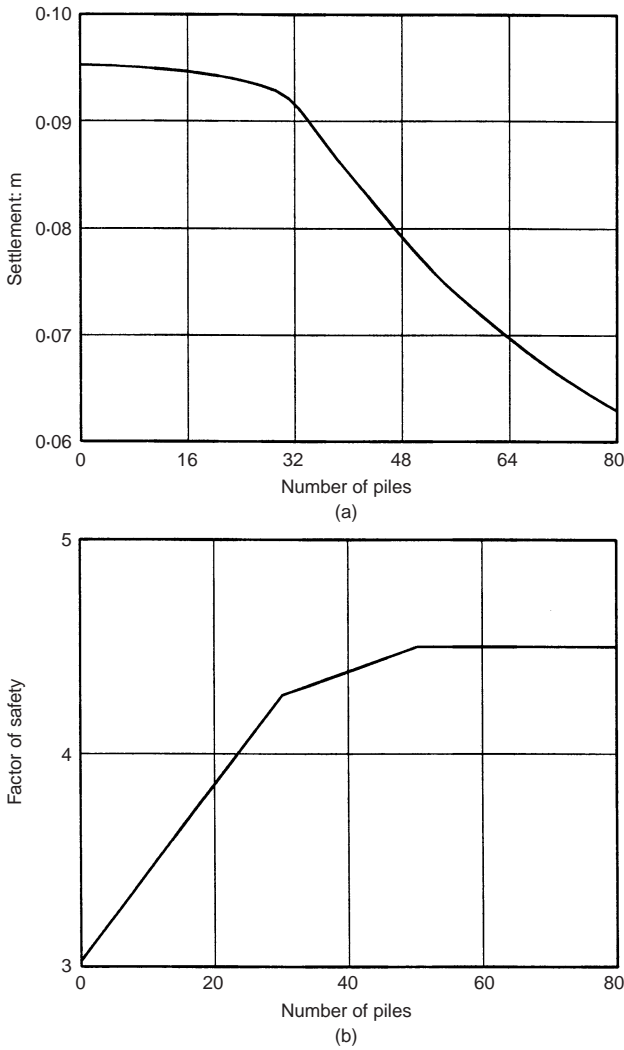

Fig. 4. Typical results from MATHCAD analysis: (a) settlement, (b) factor of safety plotted against number of piles

be located when column loadings are present. This section presents an approach that allows for an assessment of the maximum column loadings that may be supported by the raft without a pile below the column.

A typical column on a raft is shown in Fig. 5. There are at least four circumstances in which a pile may be needed below the column:

- (a) if the maximum moment in the raft below the column exceeds the allowable value for the raft
- (b) if the maximum shear in the raft below the column exceeds the allowable value for the raft
- (c) if the maximum contact pressure below the raft exceeds the allowable design value for the soil

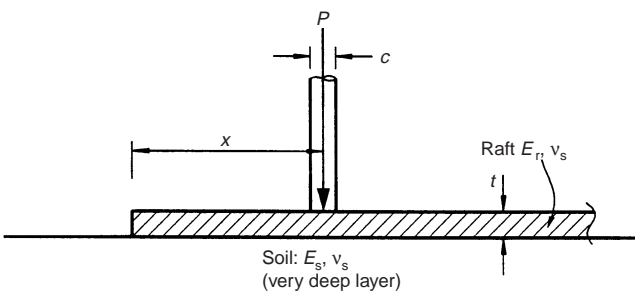

Fig. 5. Definition of problem for an individual column load

- (d) if the local settlement below the column exceeds the allowable value.

To estimate the maximum moment, shear, contact pressure and local settlement caused by column loading on the raft, use can be made of the elastic solutions summarised by Selvadurai (1979). These are for the ideal case of a single concentrated load on a semi-infinite elastic raft supported by a homogeneous elastic layer of great depth, but they do at least provide a rational basis for design. It is also possible to transform approximately a more realistic layered soil profile into an equivalent homogeneous soil layer by using the approach described by Fraser & Wardle (1976). Figure 5 shows the definition of the problem addressed, and a typical column for which the piling requirements (if any) are being assessed.

Maximum moment criterion. The maximum moments M_x and M_y below a column of radius c acting on a semi-infinite raft are given by the following approximations:

$$M_x = A_x \cdot P \tag{5a}$$

$$M_y = B_y \cdot P \tag{5b}$$

where $A_x = A - 0.0928 \ln(c/a)$; $B_y = B - 0.0928 \ln(c/a)$; A, B = coefficients depending on δ/a ; δ = distance of the column centre line from the raft edge; a = characteristic length of raft $= t[E_r(1 - \nu_r^2)/6E_s(1 - \nu_s^2)]^{1/3}$; t = raft thickness; E_r = raft Young's modulus; E_s = soil Young's modulus; ν_r = raft Poisson's ratio; and ν_s = soil Poisson's ratio. The coefficients A and B are plotted in Fig. 6 as a function of the relative distance x/a .

The maximum column load, P_{c1} , that can be carried by the raft without exceeding the allowable moment is then given by

$$P_{c1} = \frac{M_d}{\text{larger of } A_x \text{ and } B_y} \tag{6}$$

where M_d = design moment capacity of raft.

Maximum shear criterion. The maximum shear, V_{max} , below a column can be expressed as

$$V_{max} = \frac{(P - q\pi c^2)c_q}{2\pi c} \tag{7}$$

where q = contact pressure below raft; c = column radius; and c_q = shear factor, plotted in Fig. 7.

Thus if the design shear capacity of the raft is V_d the maximum column load, P_{c2} , that can be applied to the raft is

$$P_{c2} = \frac{V_d 2\pi c}{c_q} + q_d \pi c^2 \tag{8}$$

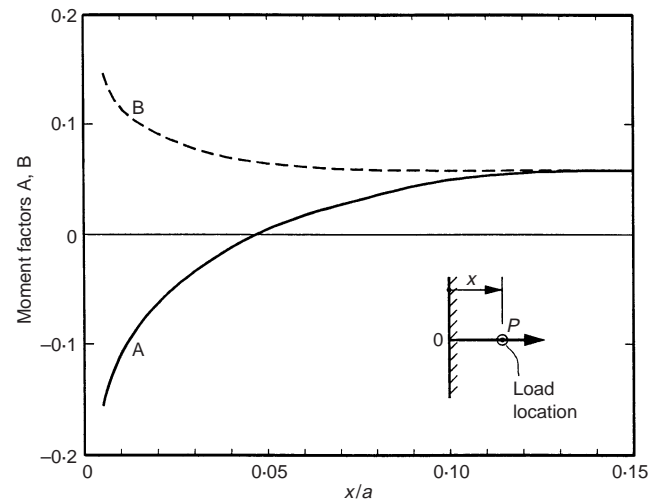

Fig. 6. Moment factors A, B for circular column

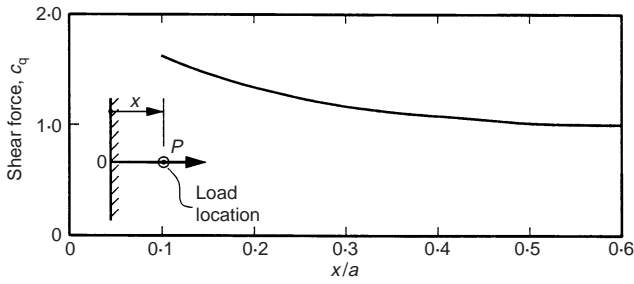

Fig. 7. Shear factor, c_q , for circular column

where q_d = design allowable bearing pressure below raft.

Maximum contact pressure criterion. The maximum contact pressure on the base of the raft, q_{max} , can be estimated as follows:

$$q_{max} = \frac{\bar{q}P}{a^2} \quad (9)$$

where \bar{q} = factor plotted in Fig. 8, and a = characteristic length defined in equation (5). The maximum column load, P_{c3} , that can be applied without exceeding the allowable contact pressure is then

$$P_{c3} = \frac{q_u a^2}{F_s \bar{q}} \quad (10)$$

where q_u = ultimate bearing capacity of soil below raft, and F_s = factor of safety for contact pressure.

Local settlement criterion. The settlement below a column (considered as a concentrated load) is given by

$$S = \frac{\omega(1 - \nu_s^2)P}{E_s a} \quad (11)$$

where ω = settlement factor plotted in Fig. 9. This expression does not allow for the effects of adjacent columns on the settlement of the column being considered, and so is a local settlement that is superimposed on a more general settlement 'bowl'.

If the allowable local settlement is S_a , then the maximum column load, P_{c4} , so as not to exceed this value is

$$P_{c4} = \frac{S_a E_s a}{\omega(1 - \nu_s^2)} \quad (12)$$

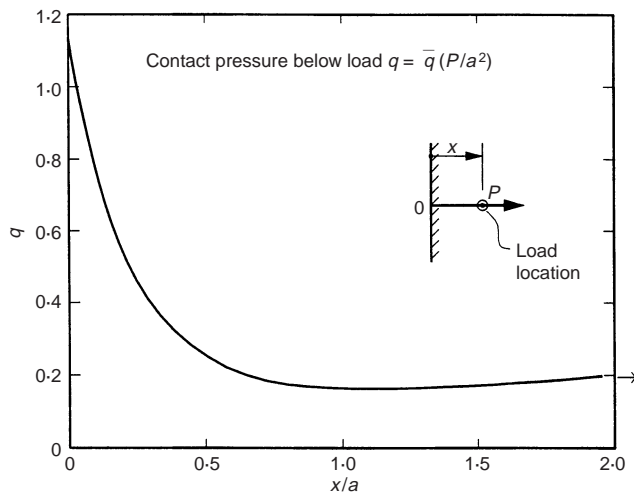

Fig. 8. Contact pressure factor, q

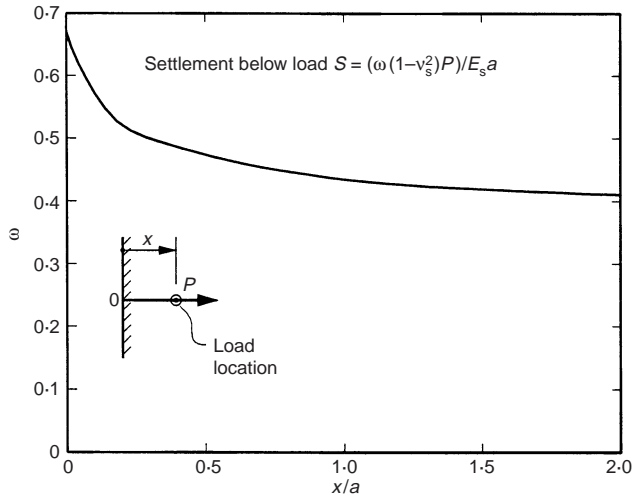

Fig. 9. Settlement factor, ω (soil assumed to be homogeneous and very deep)

Assessment of pile requirements for a column location. If the actual design column load at a particular location is P_c , then a pile will be required if P_c exceeds the least value of the above four criteria. That is, if

$$P_c > P_{crit} \quad (13)$$

where P_{crit} = minimum of P_{c1} , P_{c2} , P_{c3} or P_{c4} .

If the critical criterion is maximum moment, shear or contact pressure (i.e. P_{crit} is P_{c1} , P_{c2} or P_{c3}), then the pile should be designed to provide the deficiency in load capacity. Burland (1995) has suggested that only about 90% of the ultimate pile load capacity should be considered as being mobilised below a piled raft system. On this basis, the ultimate pile load capacity, P_{ud} , at the column location is then given by

$$P_{ud} = 1.11 F_p (P_c - P_{crit}) \quad (14)$$

where F_p = factor of safety for piles. When designing the piles as settlement reducers, F_p can be taken as unity.

If the critical criterion is local settlement, then the pile should be designed to provide an appropriate additional stiffness. For a maximum local settlement of S_a , the target stiffness, K_{cd} , of the foundation below the column is

$$K_{cd} = \frac{P_c}{S_a} \quad (15)$$

As a first approximation, using equation (1), the required pile stiffness, K_p , to achieve this target stiffness can be obtained by solving the following quadratic equation:

$$K_p^2 + K_p [K_r(1 - 2\alpha_{cp}) - K_{cd}] + \alpha_{cp}^2 K_r K_{cd} = 0 \quad (16)$$

where α_{cp} = raft-pile interaction factor, and K_r = stiffness of raft around the column. α_{cp} can be computed from equation (3), while the raft stiffness, K_r , can be estimated as the stiffness of a circular foundation having a radius equal to the characteristic length, a (provided that this does not lead to a total raft area that exceeds the actual area of the raft).

Example of critical column loads. To illustrate the maximum column loads that are computed by the approach outlined, above, an example has been considered in which a raft of thickness t is located on a deep clay layer having a Young's modulus E_s . Typical design strengths and steel reinforcement are adopted for the concrete of the raft (see Fig. 10), and design values of maximum moment and shear have been computed accordingly. The design criterion for maximum contact pressure has been taken to be a factor of safety, F_s , of 1.2, while the local settlement is to be limited to 20 mm. An interior column, well away from the edge of the raft, is assumed.

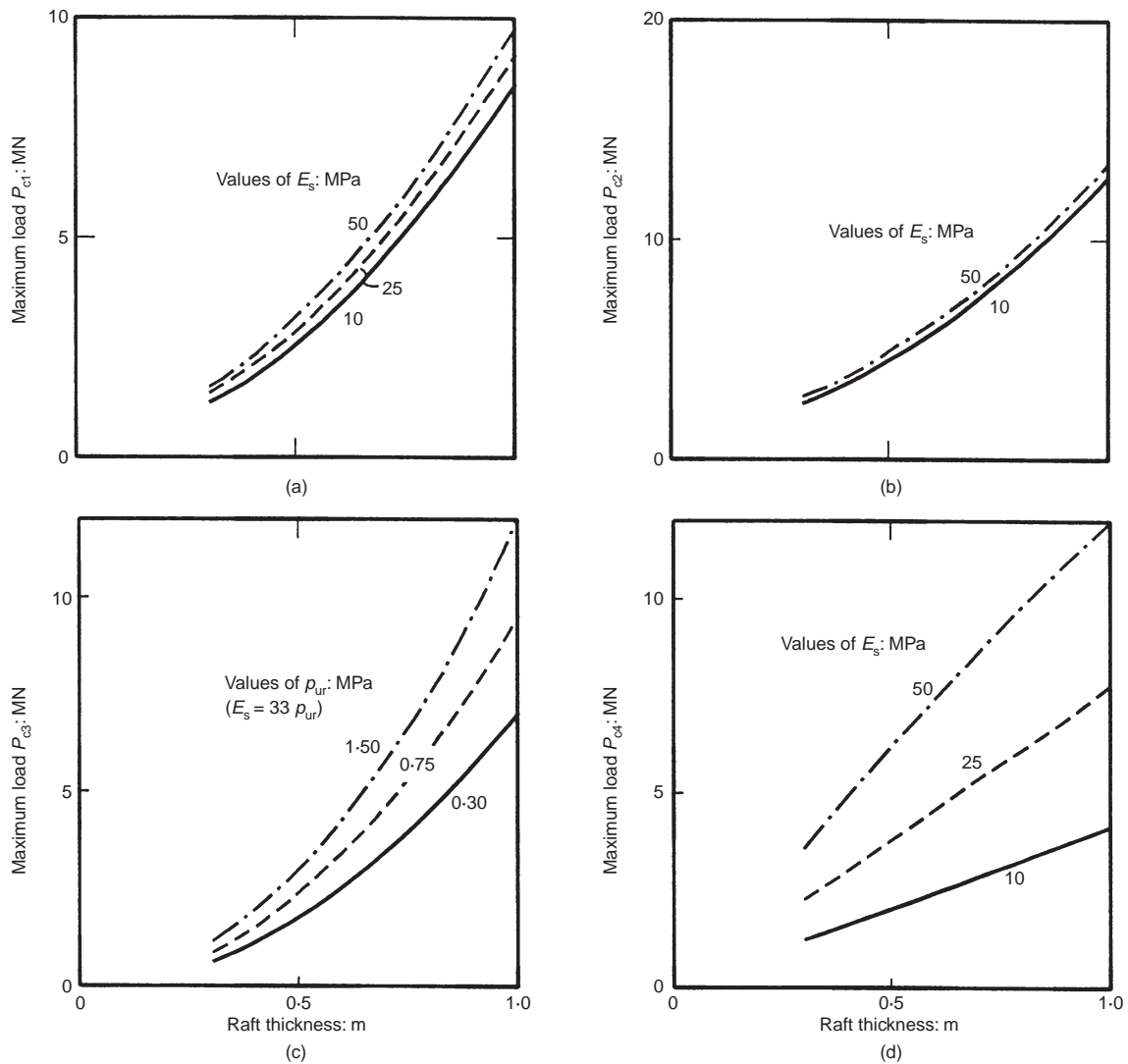

Fig. 10. Example of maximum column loads for various criteria (internal columns): (a) maximum moment criterion; (b) maximum shear criterion; (c) maximum contact pressure criterion ($FS = 1.2$); (d) maximum local settlement criterion (20 mm maximum). Concrete: $f_c = 32$ MPa; $E_r = 25\,000$ MPa. Steel: $f_y = 400$ MPa; 1% reinforcement

Figure 10 shows the computed maximum loads for the four criteria, as a function of raft thickness and soil Young's modulus. The following observations are made:

- For all design criteria, the maximum column load that may be sustained by the raft alone increases markedly with increasing raft thickness.
- The maximum column loads for bending moment and shear requirements are not very sensitive to the soil Young's modulus, whereas the maximum column loads for the contact pressure and local settlement criteria are highly dependent on soil modulus.
- For the case considered, the criteria most likely to be critical are the maximum moment and the local settlement.

Although the results in Fig. 10 are for a hypothetical case, they nevertheless give a useful indication of the order of magnitude of the maximum column loads that the raft can sustain and the requirements for piles that may need to be provided at a column location. For example if a 0.5 m thick raft is located on a soil with Young's modulus of 25 MPa, the lowest value of column load is found to be about 2.8 MN (this occurs for the maximum moment criterion). If the actual column load is 4 MN, then from equation (14), if F_p is taken as unity, the required ultimate load capacity of the pile would be $1.11 (4.0 - 2.8) = 1.33$ MN.

Detailed design stage

Once the preliminary stage has indicated that a piled raft foundation is feasible, and an indication has been obtained of the likely piling requirements, it is necessary to carry out a more detailed design in order to assess the detailed distribution of settlement and decide upon the optimum locations and arrangement of the piles. The raft bending moments and shears, and the pile loads, should also be obtained for the structural design of the foundation.

Several methods of analysing piled rafts have been developed, and some of these have been summarised by Poulos *et al.* (1997). The less simplified methods of numerical analysis tend to fall into the following categories:

- methods employing a 'strip on springs' approach, in which the raft is represented by a series of strip footings, and the piles are represented by springs of appropriate stiffness (e.g. Poulos, 1991)
- methods employing a 'plate on springs' approach, in which the raft is represented by a plate and the piles by springs (e.g. Clancy & Randolph, 1993; Poulos, 1994a; Russo & Viggiani, 1998; Viggiani, 1998; Yamashita *et al.*, 1998; Anagnostopoulos & Georgiadis, 1998)
- boundary element methods, in which both the raft and the piles within the system are discretised, and use is made of elastic theory (e.g. Butterfield & Banerjee, 1971; Kuwabara, 1989; Sinha, 1997)

- (d) methods combining boundary element analysis for the piles and finite element analysis for the raft (e.g. Hain & Lee, 1978; Ta & Small, 1996; Franke *et al.*, 1994)
- (e) simplified finite element analyses, usually involving the representation of the foundation system as a plane strain problem (Desai, 1974) or an axisymmetric problem (Hooper, 1974)
- (f) three-dimensional finite element analyses (e.g. Zhuang *et al.*, 1991; Lee, 1993; Wang, 1995 (personal communication); Katzenbach *et al.*, 1998).

Poulos *et al.* (1997) have compared some of these methods when applied to the idealised hypothetical problem shown in Fig. 11. Six methods have been used:

- (a) Poulos & Davis (1980)
- (b) Randolph (1994)
- (c) strip on springs analysis, using the program GASP (Poulos, 1991)
- (d) plate on springs approach, using the program GARP (Poulos, 1994a)
- (e) finite element and boundary element method of Ta & Small (1996)
- (f) finite element and boundary element method of Sinha (1996).

Figure 12 compares the computed characteristics of behaviour of a raft supported by nine piles, one under each column, with the overall factor of safety at the design load being 2.15. The applied load exceeds the ultimate capacity of the piles alone, and there is therefore some non-linear behaviour. Despite some differences between the various methods, most of those that incorporate non-linear behaviour give somewhat similar results, although there are significant differences among the computed raft bending moments. However, it would appear that, provided the analysis method is soundly based and takes into account the

limited load capacity of the piles, similar results may be expected for similar parameter inputs.

SOME CHARACTERISTICS OF BEHAVIOUR

In order to examine some of the characteristics of piled raft behaviour, a more detailed study has been made of the hypothetical case shown in Fig. 11. The ‘standard’ parameters shown in Fig. 11 have been adopted, but consideration has been given to the effects of variations in the following parameters on foundation behaviour:

- (a) the number of piles
- (b) the nature of the loading (concentrated versus uniformly distributed)
- (c) raft thickness
- (d) applied load level.

The analyses have been carried out using the computer program GARP (Poulos, 1994a). This program has the capability of considering the following factors:

- (a) non-homogeneous or layered soil profile
- (b) limiting pressures below the raft, in both compression and uplift
- (c) non-linear pile load–settlement behaviour, including limiting pile capacity in compression and tension
- (d) piles of different stiffness and load capacity within the foundation system
- (e) easy alteration of the location and numbers of piles
- (f) applied loadings consisting of concentrated loads, moments, and areas of uniform loading
- (g) effects of free-field vertical soil movements, such as those arising from consolidation or soil swelling.

For the case analysed, the raft has been divided into 273 elements, and for simplicity the piles have been assumed to exhibit an elastic–plastic load–settlement behaviour. The stiffness and interaction characteristics of the piles have been computed from a separate computer analysis using the program DEFPIG (Poulos, 1990). For the purposes of this example, the length and diameter of the piles have been kept constant.

Bearing capacity of raft = 0.3 MPa
 Load capacity of each pile = 0.873 MN (compression)
 = 0.786 MN (tension)

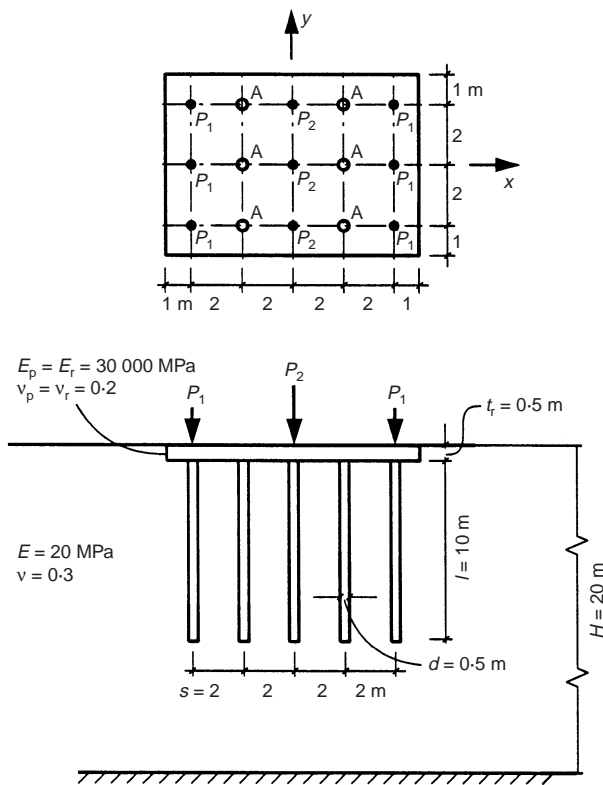

Fig. 11. Hypothetical example used to compare results of various methods of piled raft analysis; (a) average settlement; (b) maximum bending moment, M_x ; (c) differential settlement (centre–edge); (d) proportion of load carried by piles

Effect of number of piles and type of loading

Figure 13 shows the effects of the number of piles on maximum settlement, differential settlement, maximum bending moment, and the proportion of load carried by the piles. The raft thickness in this case is 0.5 m. Both concentrated loadings and a uniformly distributed load have been analysed. The following characteristics are observed:

- (a) The maximum settlement decreases with increasing number of piles, but becomes almost constant for 20 or more piles.
- (b) For small numbers of piles, the maximum settlement for concentrated loading is larger than for uniform loading, but the difference becomes very small for ten or more piles.
- (c) The differential settlement between the centre and corner piles does not change in a regular fashion with the number of piles. For the cases considered, the smallest differential settlements occur when only three piles are present, located below the central portion of the raft. The largest differential settlement occurs for nine piles, because the piles below the outer part of the raft ‘hold up’ the edges, which were not settling as much as the centre.
- (d) The maximum bending moments for concentrated loading are substantially greater than for uniform loading. Again, the smallest moment occurs when only three piles, located under the centre, are present.
- (e) The percentage of load carried by the piles increases with increasing pile numbers, but for more than about 15 piles the rate of increase is very small. The type of loading has almost no effect on the total load carried by the piles, although it does of course influence the distribution of load among the piles.

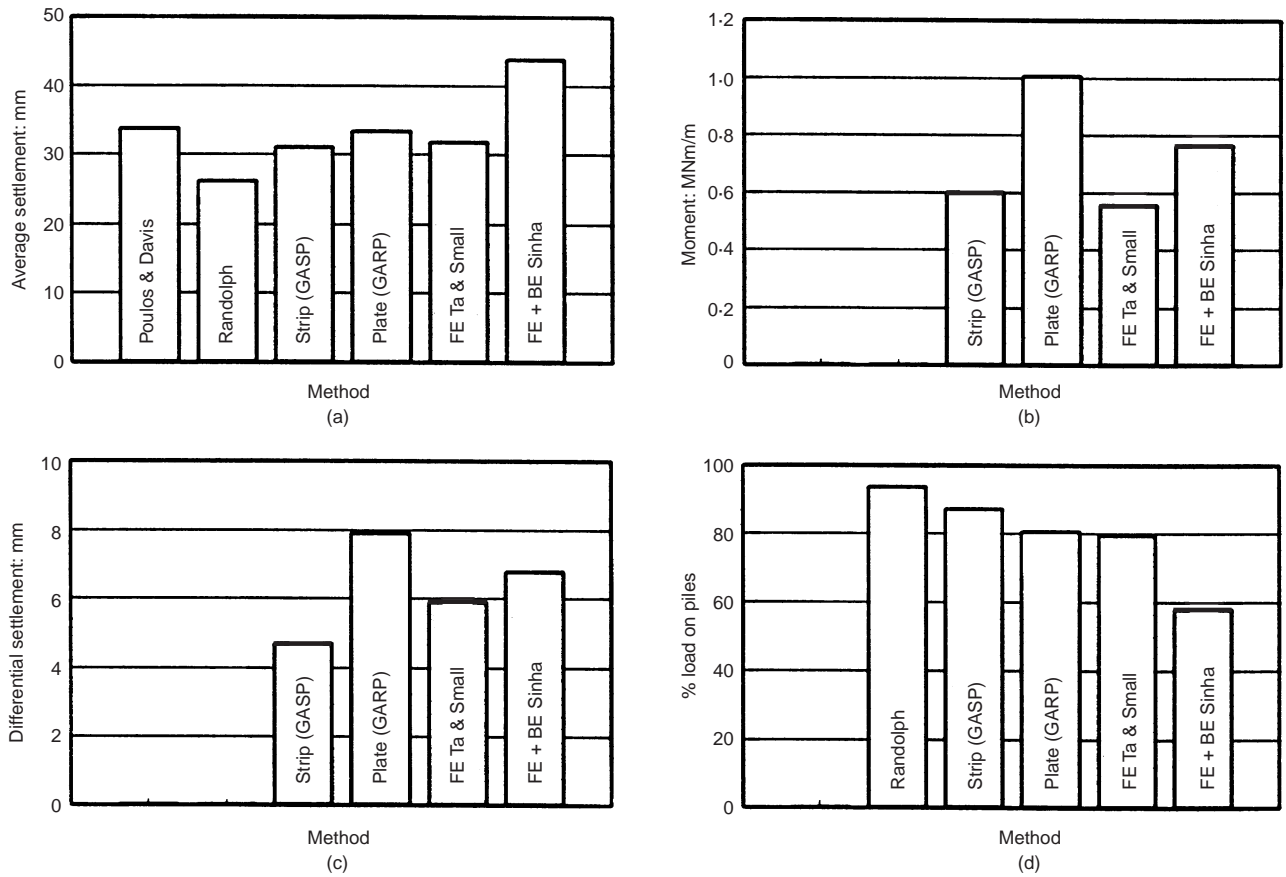

Fig. 12. Comparative results for hypothetical example (raft with 9 piles, total load = 12 MN)

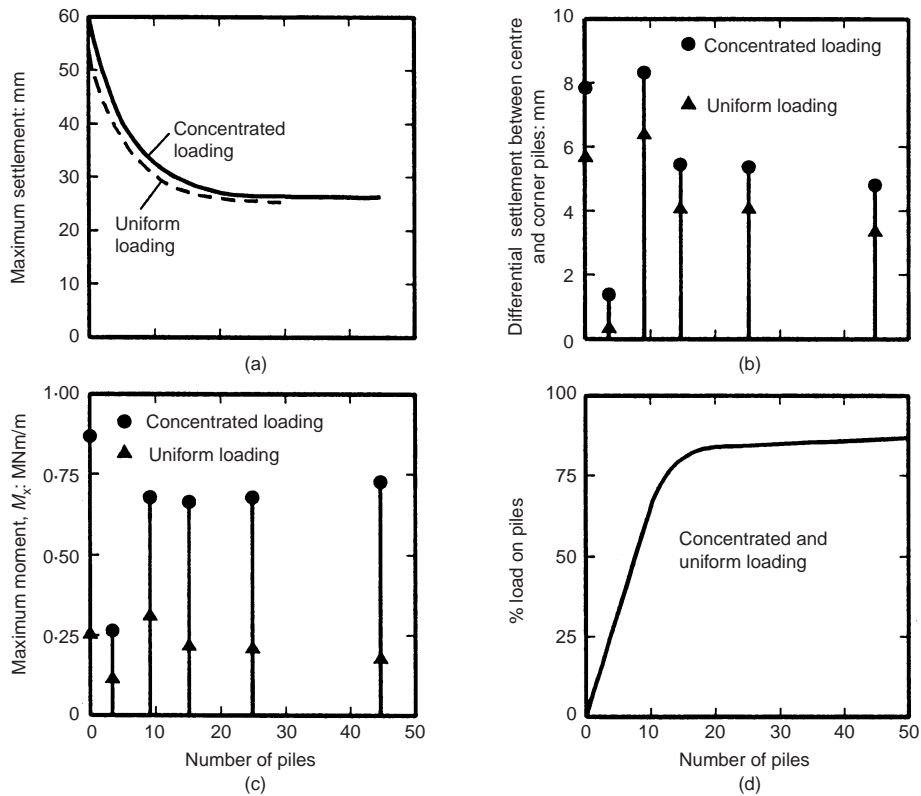

Fig. 13. Effect of number of piles on piled raft behaviour for hypothetical example (total applied load 12 MN)

Effect of raft thickness

Figure 14 shows the effect of raft thickness on raft behaviour, for the case of concentrated loadings. Neither the maximum settlement nor the percentage of load carried by the piles is very sensitive to raft thickness. However, as would be expected, increasing the raft thickness reduces the differential settlement, but generally increases the maximum bending moment. For zero piles—that is, the raft only—the raft behaviour is quite non-linear for small raft thicknesses, and the development of plastic zones below the raft tends to reduce the differential settlement. Once again, the raft with only three piles performs very well, and this clearly demonstrates the importance of locating the piles below the parts of the foundation that most require support. This is in accordance with the philosophy of designing piled rafts for differential settlement control.

Effect of load level on settlement

Figure 15 shows computed load–settlement curves for the piled raft with various numbers of piles. Clearly, the settlement increases with increasing load level, and the beneficial effects of adding piles as the design load level increases are obvious. Provided that there is an adequate safety margin, the addition of even a relatively small number of piles can lead to a considerable reduction in the maximum settlement of the foundation.

Summary

The foregoing simple example demonstrates the following important points for practical design:

- (a) Increasing the number of piles, while generally of benefit, does not always produce the best foundation performance, and there is an upper limit to the number of piles, beyond which very little additional benefit is obtained.

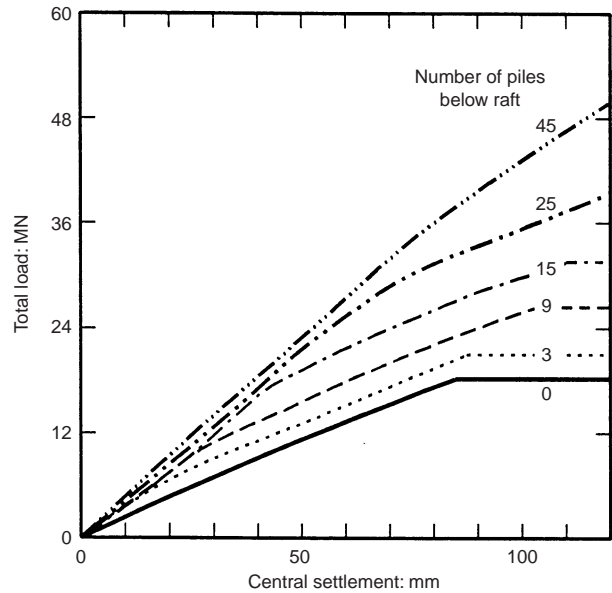

Fig. 15. Load–settlement curves for various piled raft foundation systems (concentrated loadings see Fig. 11)

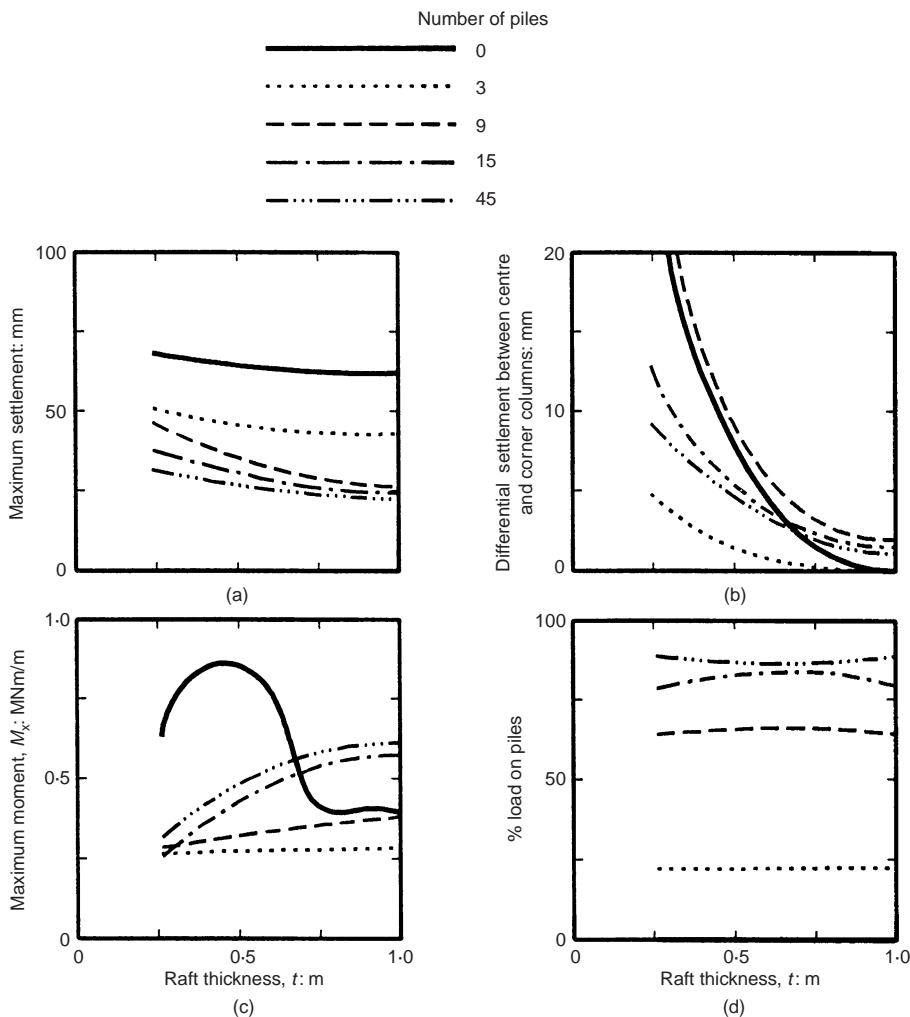

Fig. 14. Effect of raft thickness on piled raft behaviour for hypothetical example (total applied load 12 MN)

- (b) The raft thickness affects differential settlement and bending moments, but has little effect on load sharing or maximum settlement.
- (c) For control of differential settlement, optimum performance is likely to be achieved by strategic location of a relatively small number of piles, rather than by using a large number of piles evenly distributed over the raft area, or increasing the raft thickness.
- (d) The nature of the applied loading is important for differential settlement and bending moment, but is generally not very important for maximum settlement or load-sharing between the raft and the piles.

Other aspects of behaviour

Some useful further insights into piled raft behaviour have been obtained by Katzenbach *et al.* (1998), who carried out three-dimensional finite element analyses of various piled raft configurations. They used a realistic elasto-plastic soil model with dual yield surfaces and a non-associated flow rule. They analysed a square raft containing from 1 to 49 piles, as well as a raft alone, and examined the effects of the number and relative length of the piles on the load sharing between the piles and the raft, and the settlement reduction provided by the piles. An interaction diagram was developed, as shown in Fig. 16, relating the relative settlement (ratio of the settlement of the piled raft to the raft alone) to the number of piles and their length-to-diameter ratio, L/d . This diagram clearly shows that, for a given number of piles, the relative settlement is reduced as L/d increases. It also shows that there is generally very little benefit to be obtained in using more than about 20 piles or so, a conclusion that is consistent with the results of the analyses shown in Fig. 13.

An interesting aspect of piled raft behaviour, which cannot be captured by simplified analyses such as GARP, is that the ultimate shaft friction developed by piles within a piled raft can be significantly greater than that for a single pile or a pile in a conventional pile group. This is because of the increased normal stresses generated between the soil and the pile shaft by the loading on the raft. Figure 17 shows an example of the results obtained by Katzenbach *et al.* (1998). The piles within the piled raft foundation develop more than twice the shaft resistance of a single isolated pile or a pile within a normal pile group, with the centre piles showing the largest values. Thus the usual design procedures for a piled raft, which assume that the ultimate pile capacity is the same as that for an isolated pile, will tend to be conservative, and the ultimate capacity of the piled raft foundation system will be greater than that assumed in design.

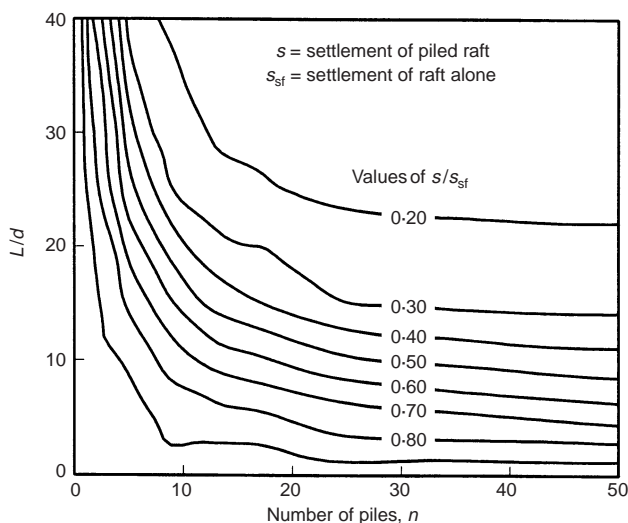

Fig. 16. Interaction diagram: settlement reduction, s/s_f , plotted against L/d and n (Katzenbach *et al.*, 1998)

GEOTECHNICAL PARAMETER ASSESSMENT

The design of a piled raft foundation requires an assessment of a number of geotechnical and performance parameters, including:

- (a) raft bearing capacity
- (b) pile capacity
- (c) soil modulus for raft stiffness assessment
- (d) soil modulus for pile stiffness.

While there are a number of laboratory and *in situ* procedures available for the assessment of these parameters, it is common for at least initial assessments to be based on the results of simple *in situ* tests such as the standard penetration test (SPT) and the static cone penetration test (CPT). Typical of the correlations are the following, which the author has employed, based on the work of Decourt (1989, 1995) using the SPT:

Raft ultimate bearing capacity:

$$p_{ur} = K_1 N_r \quad \text{kPa} \quad (17)$$

Pile ultimate shaft resistance:

$$f_s = a[2.8N_s + 10] \quad \text{kPa} \quad (18)$$

Pile ultimate base resistance:

$$f_b = K_2 N_b \quad \text{kPa} \quad (19)$$

Soil Young's modulus below raft:

$$E_{sr} = 2N \quad \text{MPa} \quad (20)$$

Young's modulus along and below pile:

$$E_s = 3N \quad \text{MPa} \quad (21)$$

where N_r = average SPT (N_{60}) value within depth of one-half of the raft width; N_s = SPT value along pile shaft; N_b = average SPT value close to pile tip; K_1 , K_2 = factors shown in Table 1; $a = 1$ for displacement piles in all soils and non-displacement piles in clays, and 0.5–0.6 for non-displacement piles in granular soils.

SOME TYPICAL APPLICATIONS

Westend 1 Tower, Frankfurt

The Westend 1 Tower is a 51-storey, 208 m high building in Frankfurt, Germany, and has been described by Franke *et al.* (1994) and Franke (1991). A cross-section and foundation plan of the building are shown in Fig. 18. The foundation for the tower consists of a piled raft with 40 piles, each about 30 m long and 1.3 m in diameter. The central part of the raft is 4.5 m thick, decreasing to 3 m at the edges. While full details of the geotechnical profile are not available in the published literature, it appears that the building is located on a thick deposit of relatively stiff Frankfurt clay. On the basis of pressuremeter tests, an average reloading soil modulus of 62.4 MPa has been reported by Franke *et al.* (1994).

Calculations have been reported by Poulos *et al.* (1997) to predict the behaviour of the building, using a number of different analysis methods:

- (a) a finite element analysis (Ta & Small, 1996)
- (b) the GARP analysis described earlier in this paper
- (c) a piled strip analysis (Poulos, 1991)
- (d) the simple hand calculation method described by Poulos & Davis (1980)
- (e) the approximate linear method developed by Randolph (1983, 1994)
- (f) the combined finite element and boundary element method developed by Sinha (1997)
- (g) the combined finite element and boundary element method described by Franke *et al.* (1994).

Figure 19 compares the predictions of performance for the above methods, together with the measured values. The calculations have been carried out for a total load of 968 MN, which is

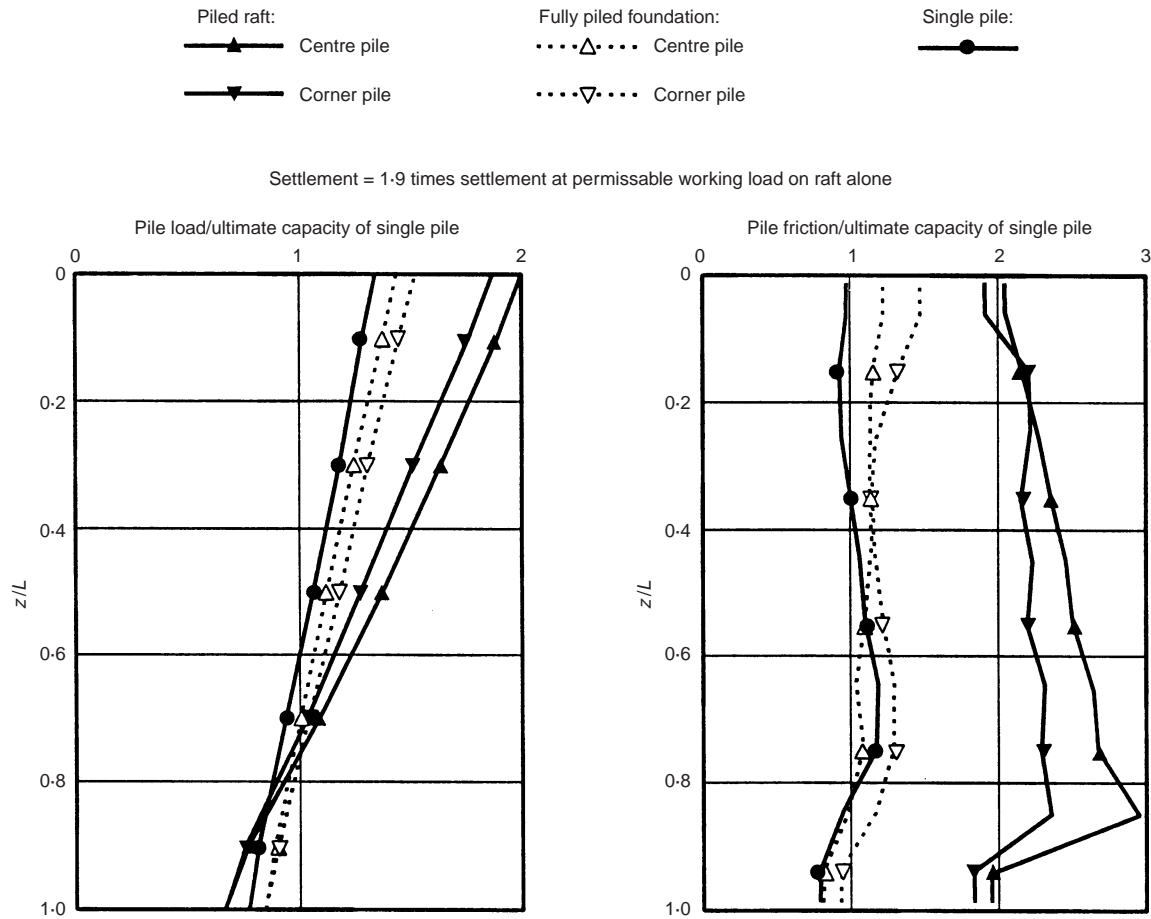

Fig. 17. Distribution of the pile load and the skin friction along the pile shaft: raft with 13 piles (Katzenbach *et al.*, 1998)

Table 1. Correlation factors K_1 and K_2

Soil type	K_1 (raft)	K_2 (displacement piles)	K_2 (non-displacement piles)
Sand	90	325	165
Sandy silt	80	205	115
Clayey silt	80	165	100
Clay	65	100	80

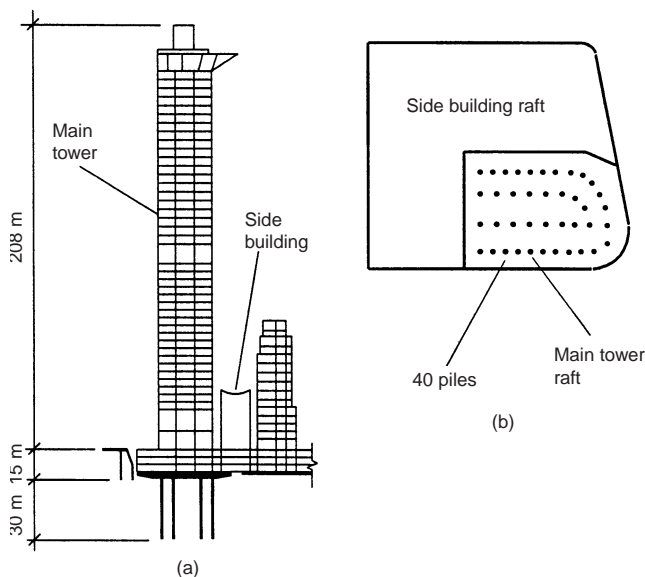

Fig. 18. Westend 1 Tower, Frankfurt, Germany (Franke *et al.*, 1994): (a) cross-section; (b) foundation plan

equivalent to an average applied pressure of 323 kPa. The following points are noted:

- (a) The measured maximum settlement is about 105 mm, and most methods tend to over-predict this settlement. However, most of the methods provide an acceptable design prediction.
- (b) The piles carry about 50% of the total load. Most methods tended to over-predict this proportion, but from a design viewpoint most methods give acceptable estimates.
- (c) All methods capable of predicting the individual pile loads suggest that the load capacity of the most heavily loaded piles is almost fully utilised; this is in agreement with the measurements.
- (d) There is considerable variability in the predictions of minimum pile loads. Some of the methods predicted larger minimum pile loads than were actually measured.

This case history clearly demonstrates that the design philosophy of fully utilising pile capacity can work successfully and produce an economical foundation that performs satisfactorily. The available methods of performance prediction appear to provide a reasonable, if conservative, basis for design in this case.

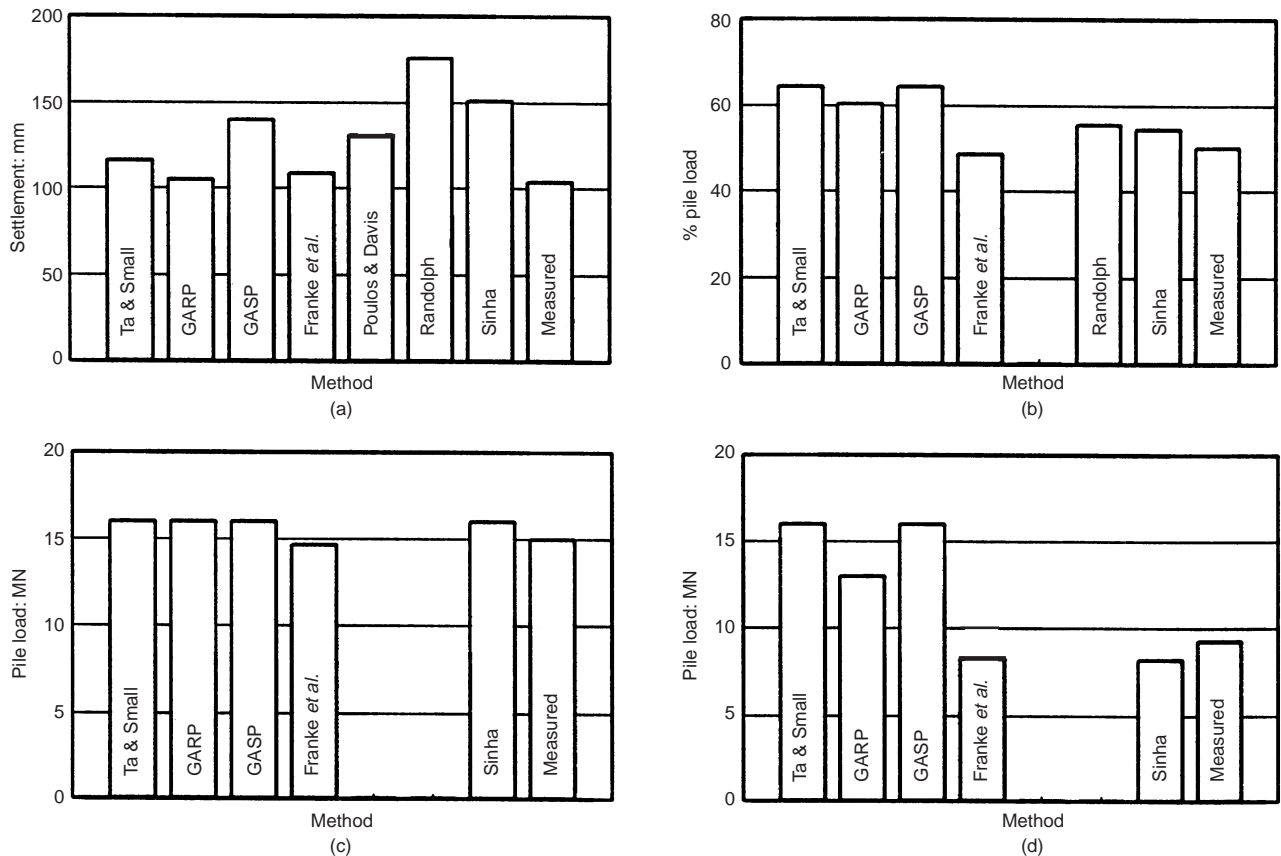

Fig. 19. Comparison of analysis methods for piled raft foundation, Westend 1 Tower, Frankfurt, Germany: (a) central settlement; (b) proportion of pile load; (c) maximum pile load; (d) minimum pile load

Five-storey building in Urawa, Japan

Yamashita *et al.* (1994, 1998) have described a well-instrumented and documented case of a piled raft foundation for a five-storey building on stiff clay in Japan. Figure 20 illustrates the geotechnical conditions, the basic parameters obtained from laboratory and field testing, and the building footprint, which was rectangular, with sides 24 m by 23 m. The foundation consisted of a raft (inferred to be 0.3 m thick) with 20 piles, one under each column. The piles were bored concrete piles, either 0.8 or 0.7 m in diameter, with a central steel H-pile inserted. The pile diameter and steel pile size depended on the column load, which ranged between 1.02 MN and 3.95 MN.

The program GARP was used to analyse this case, using the values of soil Young's modulus reported by Yamashita *et al.* Figure 21 shows the computed and measured settlements along three lines. Also shown are the values calculated by Yamashita *et al.* (1994). The settlements computed by GARP are in reasonable agreement with, although generally a little larger than, the measured values. The GARP values are also in fair agreement with the values computed by Yamashita *et al.* Figure 22 compares computed and measured pile loads. In general, the computed pile loads are higher than the measured values, although the general trends with respect to pile load distribution are reasonably well reproduced by the analysis. The GARP pile loads are also in general agreement with those computed by Yamashita *et al.*, although there are some differences at a few column locations. In general, however, the agreement between measured and computed piled raft behaviour is reasonable.

This case provides an opportunity to check the criteria developed above in the section 'The design process' for the maximum loads that can be applied to a raft before piles are required. It is found that, making reasonable assumptions regarding the concrete and reinforcing steel properties, the maximum column loads that could be sustained by the raft alone are about 1.44 MN for internal columns and 0.50 MN for columns

near the edge of the raft. On this basis, it would be concluded that piles are required under all 20 columns, and this indeed was the actual case. To investigate how the foundation would perform if some of the piles were removed, GARP analyses were carried out with piles removed below the least heavily loaded columns, but it was found that the foundation performance was affected very adversely unless the raft thickness was increased substantially. Hence it would appear that the criteria in 'The design process' would have provided appropriate guidance in the selection of locations for the piles to be provided.

This case also provides an opportunity to examine the performance, predicted by GARP, of alternative foundation designs, in particular a raft without piles, and a piled raft with a thicker raft. Figure 23 shows the computed settlement and bending moment profiles along column line B for the piled raft and a raft 0.3 m thick, without piles. The raft without piles suffers substantially larger settlements, and very large bending moments (actually far in excess of the structural capacity of the raft). Figure 24 shows the corresponding results for piled rafts with raft thicknesses of 0.3 m and 0.75 m. In this case, the thicker raft serves merely to even out the settlement profile, but increases the bending moments significantly. The results in Figs 23 and 24 therefore indicate the considerable benefits of locating piles below the columns, and the feasibility of using relatively thin rafts in conjunction with piles.

Messe Turm Tower, Frankfurt

This building is one of the pioneering structures designed to be supported on a piled raft foundation. It has been described extensively in the literature (e.g. Sommer *et al.*, 1991; Tamaro, 1996; El-Mossallamy and Franke, 1997). The Messe Turm tower is 256 m high, and at the time of its construction was the tallest building in Europe. It is supported by a raft 6 m thick in the central portion, decreasing to 3 m at the edges. A total of 64

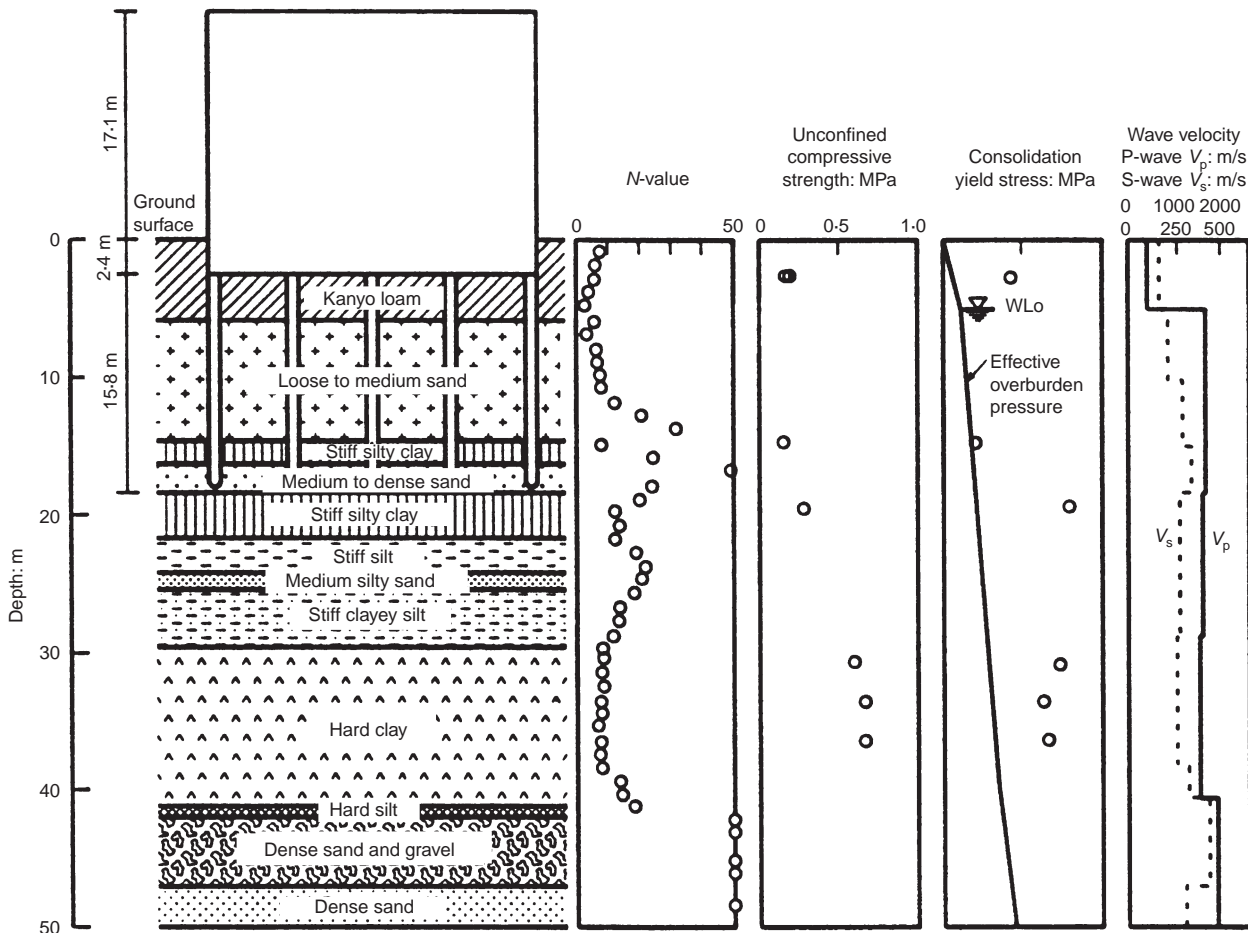

(a)

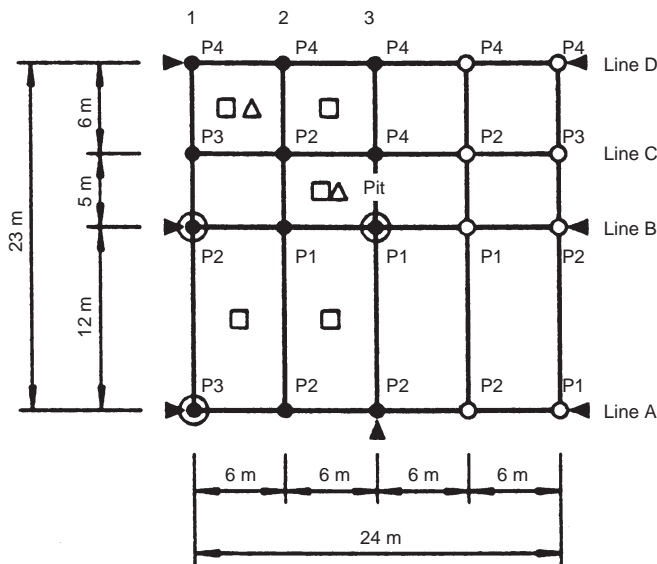

Pile no.	Borehole dia.: m	Size of steel-H: mm
P1	0.80	414 × 405 × 18 × 28
P2	0.80	400 × 400 × 13 × 21
P3	0.70	350 × 350 × 12 × 19
P4	0.70	300 × 300 × 10 × 15

(b)

Fig. 20. Five-storey building in Japan (Yamashita *et al.*, 1994): (a) elevation of building and summary of soil investigation; (b) foundation plan

piles are present, arranged in three concentric circles below the raft. The piles are 1.3 m in diameter, and vary in length from 26.9 to 34.9 m. The distance between the piles varies from 3.5 to 6 pile diameters. Figure 25 shows details of the foundation. The piles were designed to develop their full geotechnical capacity and to carry about half of the design load.

Extensive instrumentation was installed to monitor foundation performance, with measurements including foundation settle-

ment and rotation, subsurface settlement, pile head loads, and distribution of load along the length of the pile.

The foundation behaviour was complicated by drawdown of the groundwater table arising from a nearby subway excavation. Figure 26 shows the measured time-settlement behaviour of the tower (Tamaro, 1996), and indicates that the total settlement of the building was about 115 mm as at the end of 1995, approximately 7 years after the commencement of construction. Also

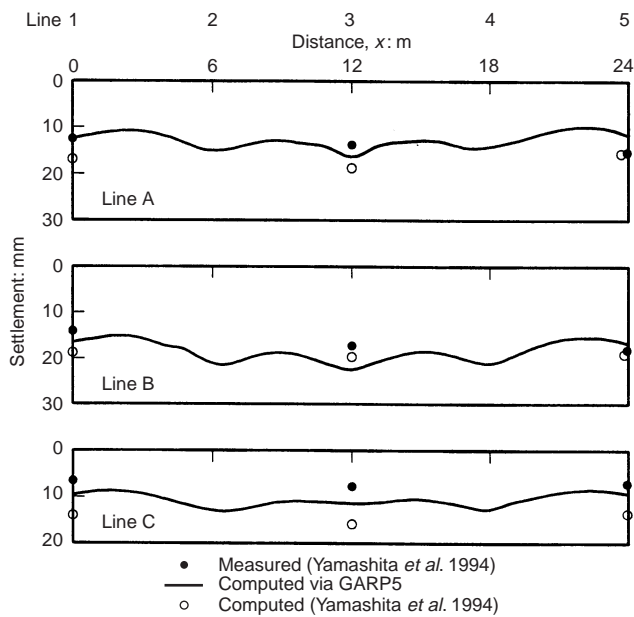

Fig. 21. Computed and measured settlements: case of Yamashita *et al.* (1994)

shown in Fig. 26 is the predicted time–settlement behaviour, which agrees reasonably well with the measurements. This pioneering project again demonstrates the feasibility of designing piled raft foundations with the piles developing their full capacity.

Residential buildings in Sweden

Hansbo (1993) has presented a case history involving two similar buildings supported by piles. The first was designed using a traditional approach, with a factor of safety of 3 for the piles. A total of 211 piles, 28 m long were used. The second was designed using the 'creep pile' concept, in which the piles were designed as settlement reducers, with a factor of safety for the piles of the order of 1.25. This building was supported on only 104 piles, 26 m long. Figure 27 shows the measured settlement contours for each building, and the measured relationship between average settlement and time. Despite the fact that the second building was supported on less than half the number of piles, it settled no more (in fact, slightly less) than the first building. This case clearly demonstrates the potential economy that may be achieved by the use of the piled raft design concept, without significant sacrifice of foundation performance.

Stonebridge Park apartment building

This case history was first reported by Cooke *et al.* (1981), and has been revisited by a number of subsequent researchers. The actual foundation involved the use of a raft 0.9 m thick, with 351 piles, 450 mm in diameter and 13 m long, driven into London Clay. Using a piled raft analysis via the computer program NAPRA, Viggiani (1998) was able to obtain good agreement between the calculated and observed settlement (Fig. 28). Viggiani also carried out an interesting theoretical exercise of reducing the number of piles progressively, and observing the effects on the settlement and load sharing between the raft and the piles. The results of this exercise are shown in Fig. 29. For the original foundation, virtually all the load was carried by the piles. Reducing the number of piles had very little effect on either the settlement or the amount of load carried by the raft until the number of piles became less than about 200. Even with 117 piles (one-third of the original number), the settlement increase was only about 50%, while the factor of safety was reduced by about 58%.

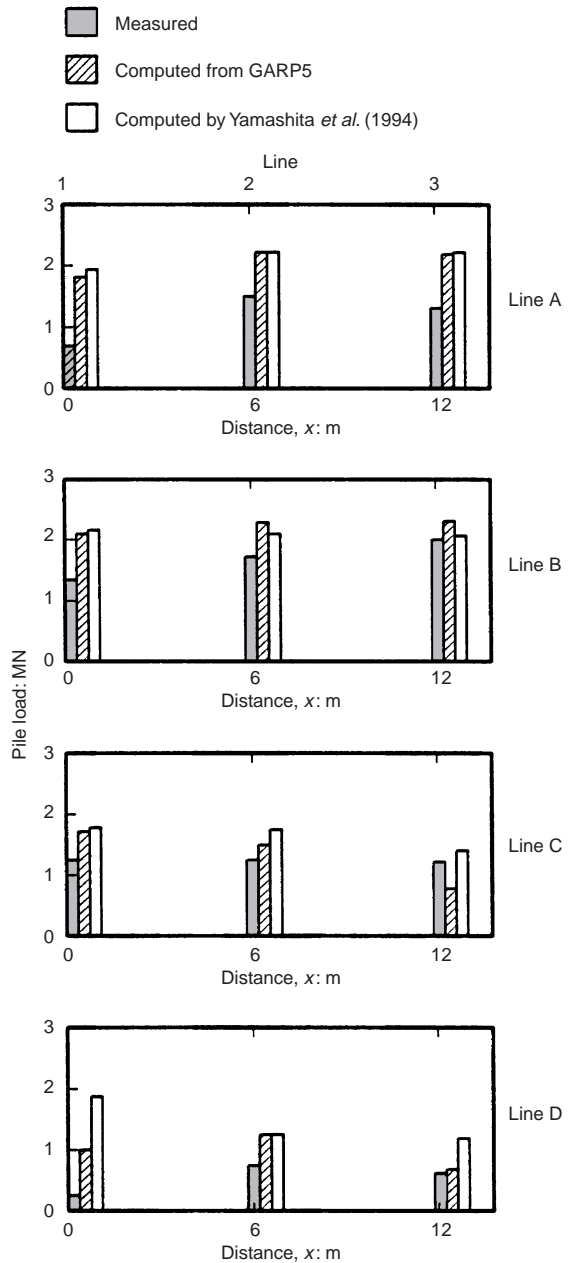

Fig. 22. Computed and measured pile loads: case of Yamashita *et al.* (1994)

Viggiani also showed that the number and layout of piles was significant in terms of the differential settlement. While reducing the number of piles tended to increase the differential settlement, concentrating the piles towards the centre of the foundation led to a marked reduction in the differential settlement. This conclusion is also supported by the work of Horikoshi & Randolph (1998).

Commercial building in Sao Paulo, Brazil

Poulos (1994b) has described the application of the piled raft design concept to the Akasaka commercial building in Sao Paulo. The building consists of a multi-storey block, occupying a total rectangular footprint of 44.5 m by 26.75 m. The foundations consist of individual footings below each column, with piles below the more heavily loaded columns to reduce differential settlements. Figure 30 shows the foundation plan, while Fig. 31 summarises the geotechnical profile.

Analyses were carried out for footing SP11, in order to assess the necessary number of piles required to satisfy the

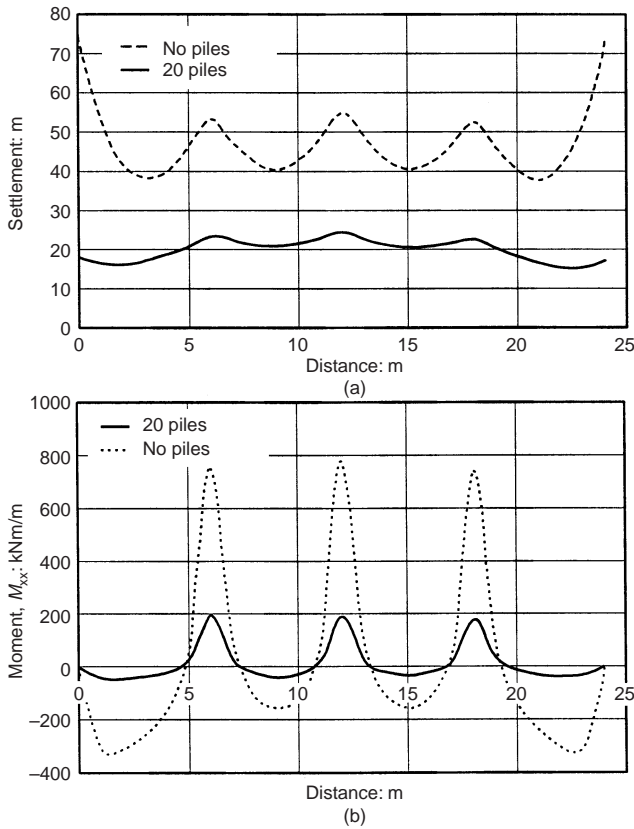

Fig. 23. (a) Computed settlement and (b) moment distribution with and without piles, line B: case of Yamashita *et al.* (1994)

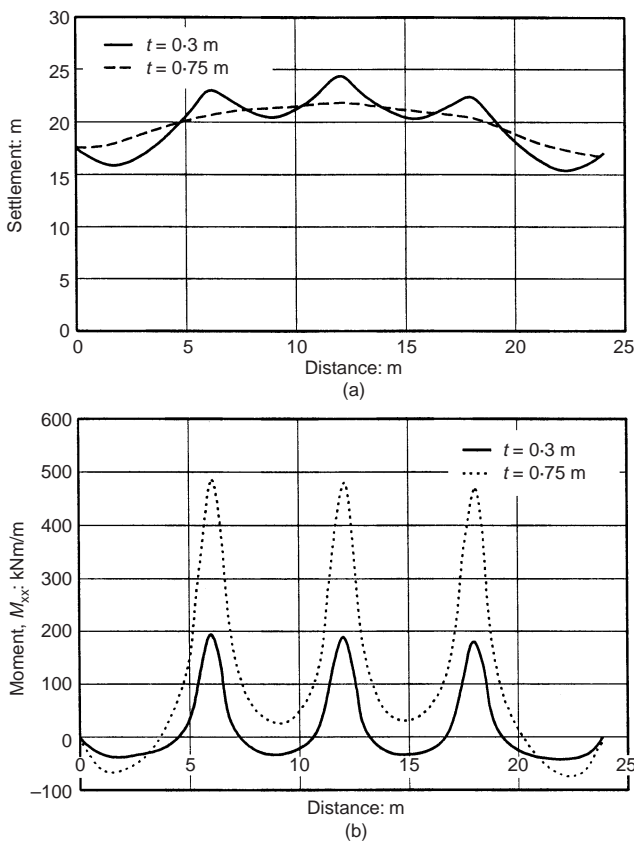

Fig. 24. Effect of raft thickness on (a) computed settlement and (b) moment profiles, line B: case of Yamashita *et al.* (1994)

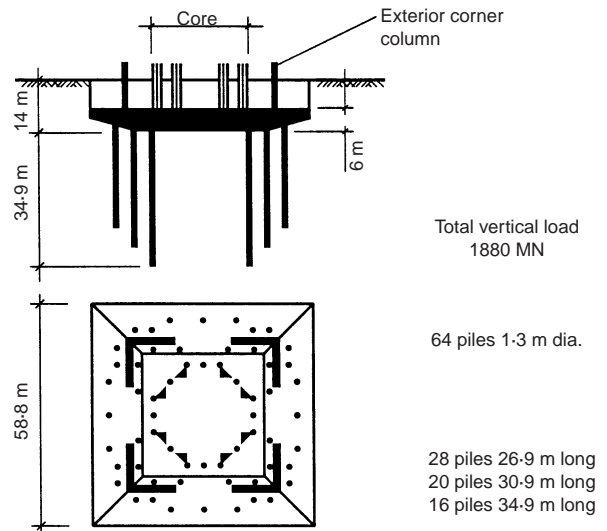

Fig. 25. Piled raft foundation for Messe Turm Tower, Frankfurt, Germany

design requirement of a maximum settlement of 30 mm. Precast reinforced concrete piles 520 mm in diameter, and extending about 12 m below the basement raft level, were assumed. The estimated ultimate load capacity of each pile was about 2500 kN. Preliminary design calculations were carried out to give the required number of piles for various values of factor of safety of the piles. A conventional design approach, assuming a safety factor of 2.5 for the piles, and ignoring the effect of the footing, would require 23 piles. For a design based on the concept of full utilisation of pile capacity, only eight piles are required, and an overall factor of safety for the piles and the footing is 2.5.

For a detailed analysis of the various design options, the program GARP was used, with the necessary geotechnical parameters being estimated on the basis of correlations with SPT data (Decourt, 1989). Fig. 32 shows the computed variation of maximum settlement with the number of piles, for raft thicknesses of 0.5, 0.75 and 1.0 m. In this case, the settlement ranged from over 50 mm for an unpiled footing to about 20 mm for about ten piles or more. The characteristics of behaviour are very similar to those in Figs 13 and 14: that is, there is little benefit in adding piles beyond a certain number (in this case, about ten), and there is relatively little effect of raft thickness on the maximum settlement.

For a maximum settlement of 30 mm, Fig. 32 indicates that only about six piles would be required; such a foundation system would have an overall factor of safety of about 2.25, and was in fact recommended by the consulting engineer on the project as the appropriate design for that foundation.

CONCLUSIONS

This paper demonstrates that the design of piled raft foundation systems can be carried out as a three-stage process, involving a preliminary design phase to obtain an approximate assessment of the required number of piles, a second phase to assess where piles may be required, and a detailed design phase to refine piling requirements and locations and provide information for the structural design of the foundation.

Alternative design strategies for the design of the piles have been discussed, and it has been demonstrated that effective and efficient foundations can be designed by utilising a significant part (if not all) of the available capacity of the piles. This philosophy of designing piles as settlement reducers can lead to foundations with fewer piles than in a conventional design, but which can still satisfy the specified design criteria with respect to ultimate load capacity and settlement. The conventional approach of assuming that all the load should be carried by the piles can often lead to an over-conservative and uneconomical

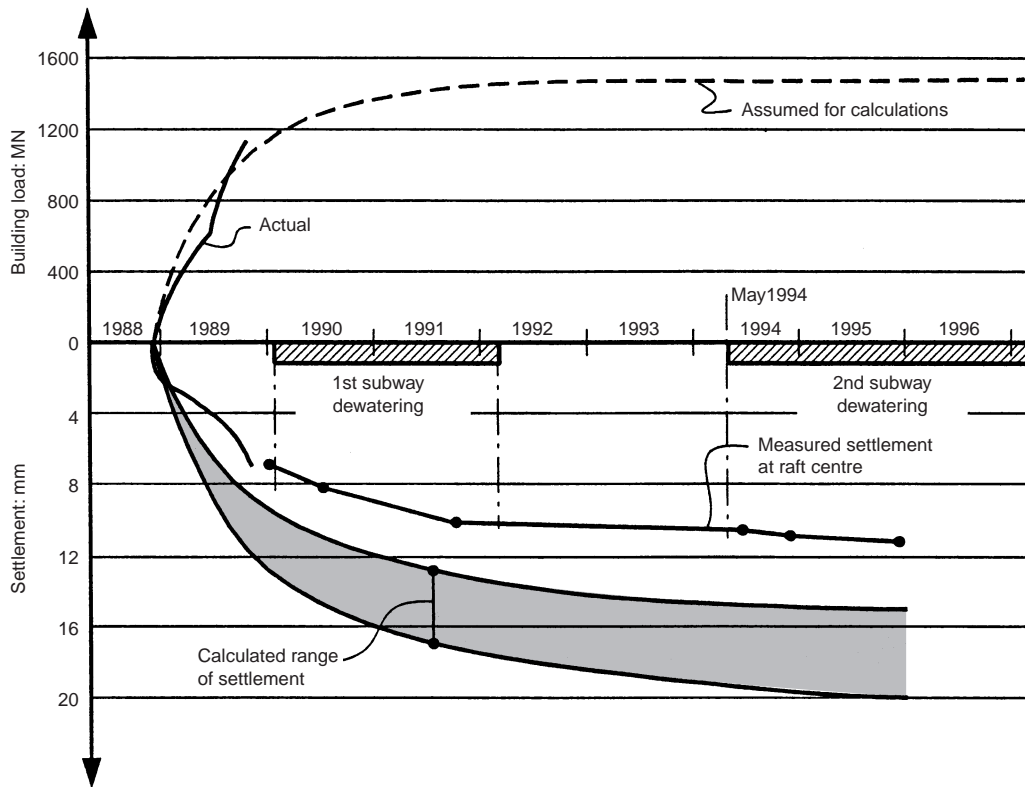

Fig. 26. Calculated and measured settlements for Messe Turm Tower, Frankfurt, Germany (after Tamaro, 1996)

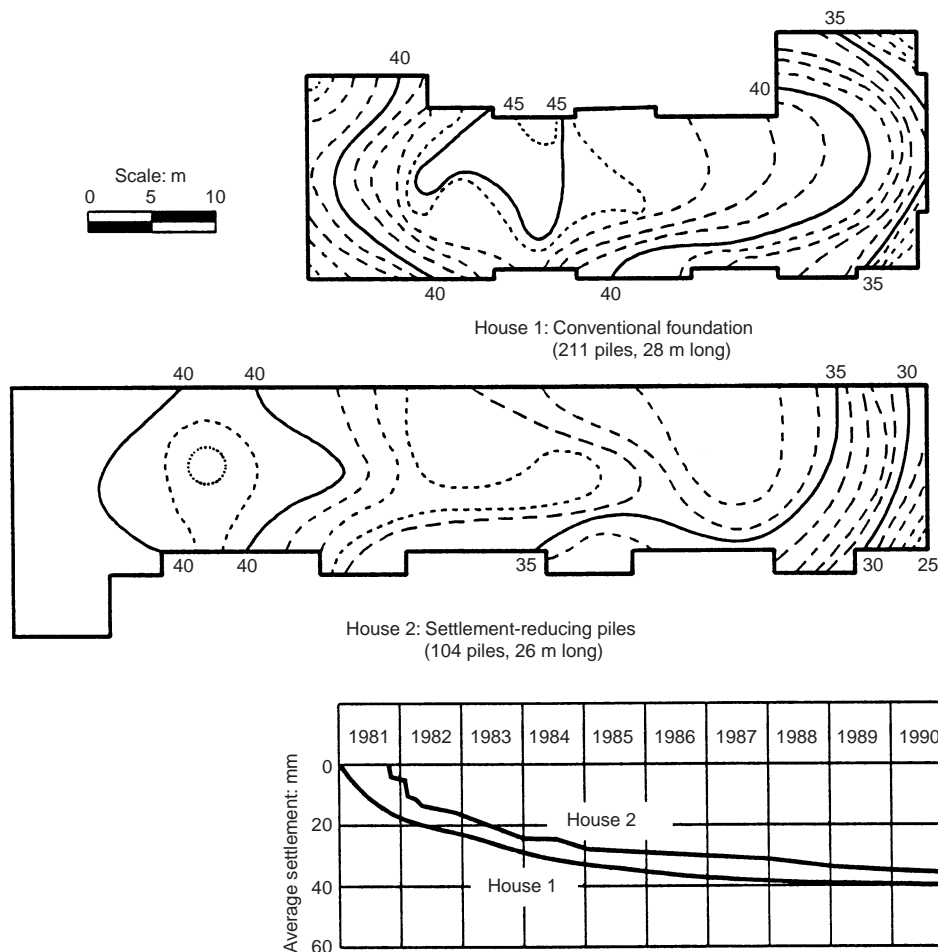

Fig. 27. Settlements for two adjacent residential buildings (Hansbo, 1993)

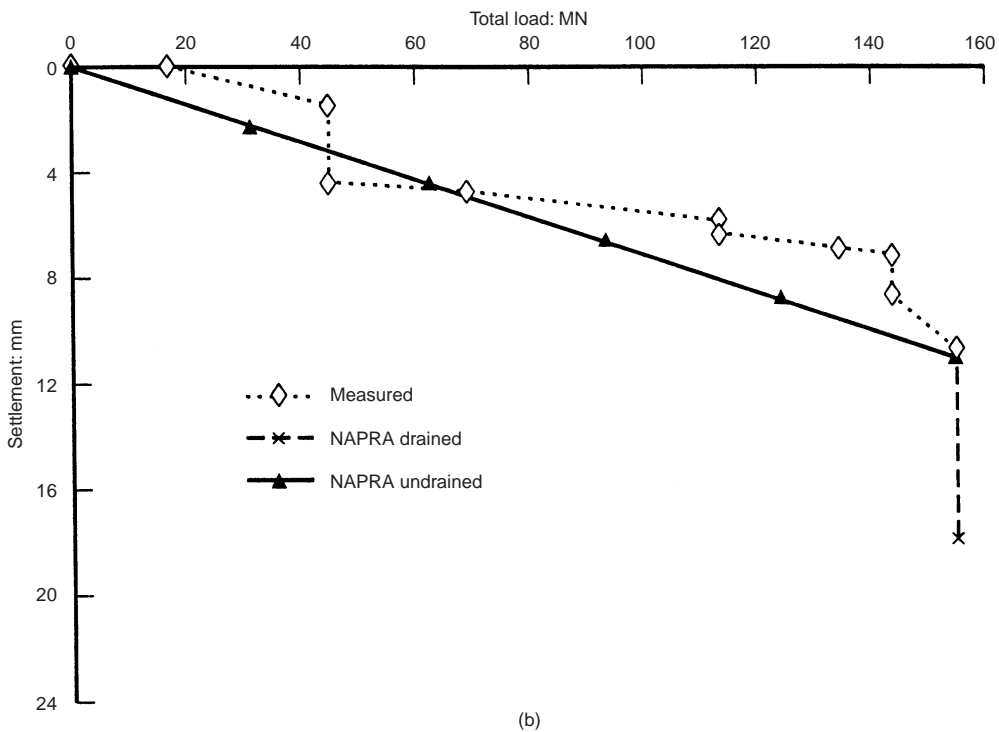
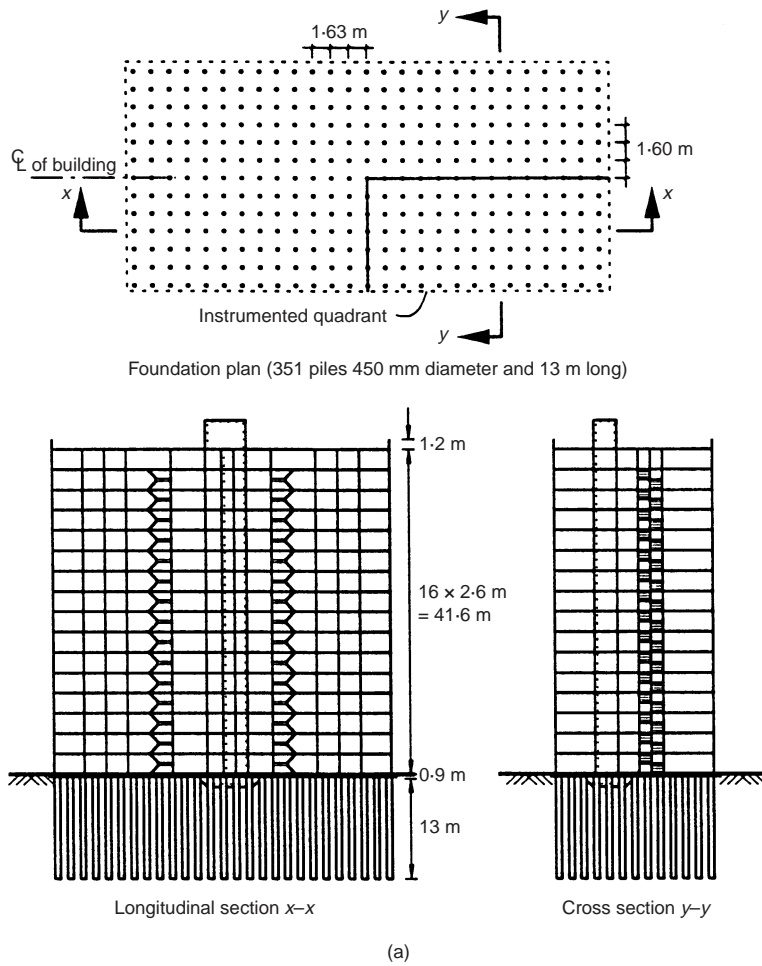

Fig. 28. Stonebridge Park case (after Viggiani, 1998): (a) foundation details; (b) comparison between the observed values and those predicted by NAPRA

design. It is also important to note that using an increasing number of piles to improve foundation performance works only up to a certain point, beyond which adding further piles results in almost no additional benefit.

The piled raft foundation solution is not suitable for every circumstance. It is unlikely to be very effective if soft clays or loose sands exist near the surface, and it is generally not a suitable option if ground movements are likely to occur below

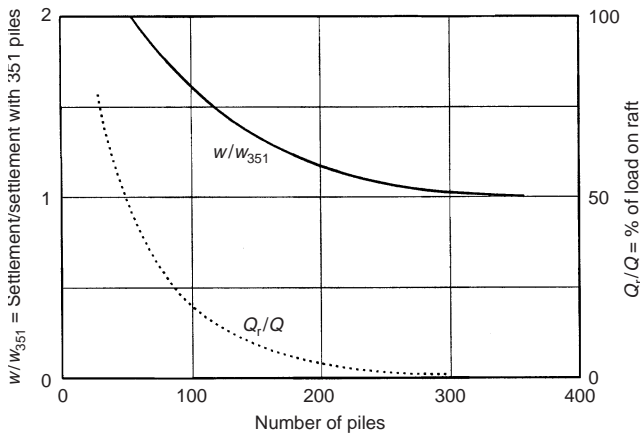

Fig. 29. Effect of number of piles on settlement and load sharing for Stonebridge Park (Viggiani, 1998)

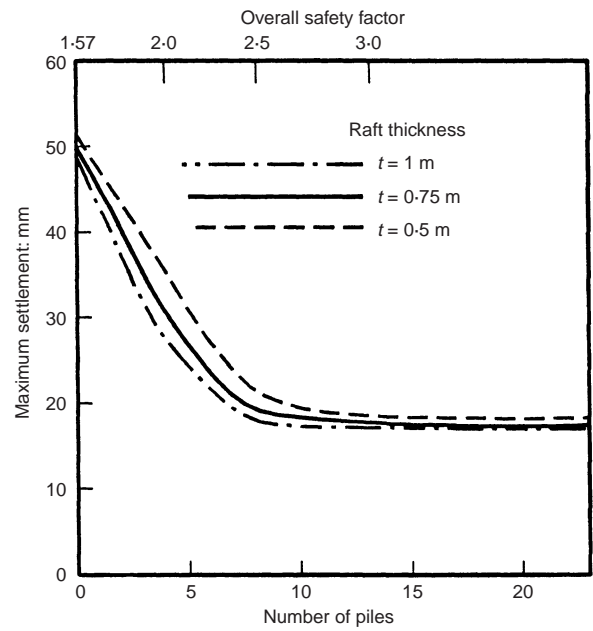

Fig. 32. Computed relationship between maximum settlement and number of piles, Akasaka building, Sao Paolo

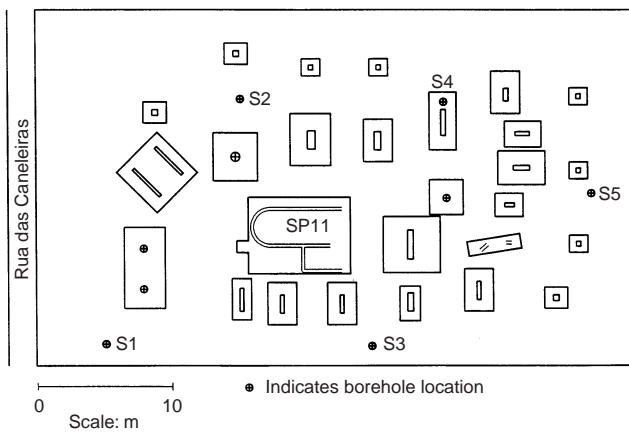

Fig. 30. Akasaka building, Sao Paolo, Brazil: foundation plan

the raft. However, in cases where the soil conditions allow the raft to develop adequate capacity and stiffness, the piled raft solution may be very suitable.

The main obstacles to increased use of this type of foundation appear to be two-fold: an inherent conservatism in foundation design by some foundation engineers; and restrictions imposed by some building codes on the minimum factors of safety that may be employed in pile design. On the positive side, there is an increasing number of examples of successful use of piled rafts. Also, there is a rapidly increasing understanding of the mechanics of behaviour of piled rafts, and a

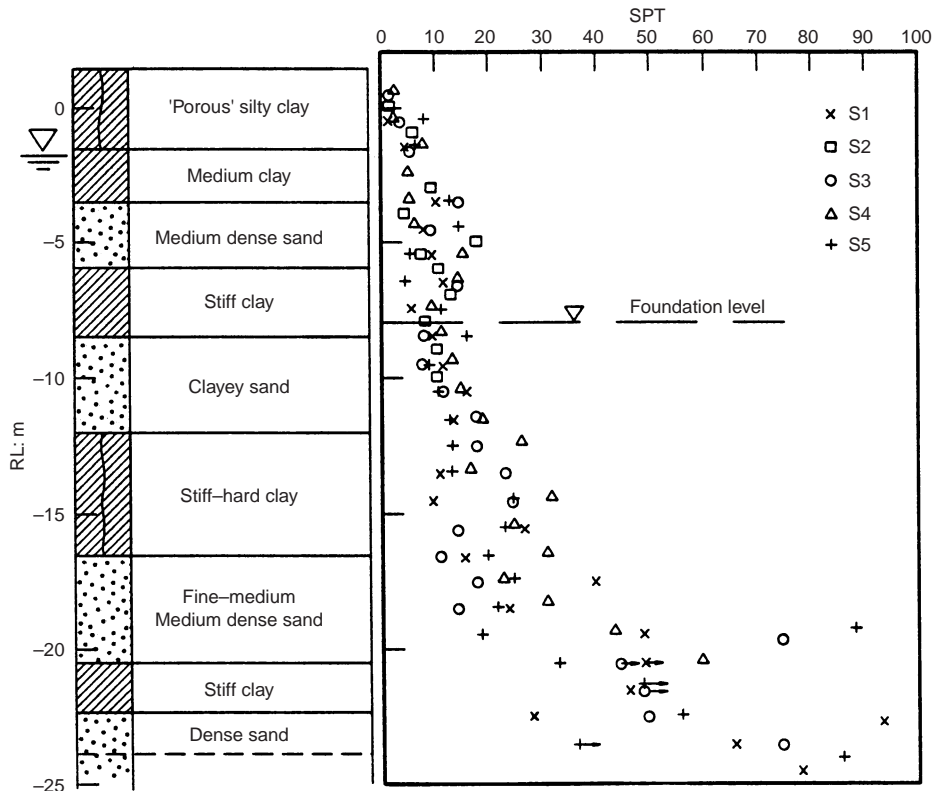

Fig. 31. Typical geotechnical profile for Akasaka building, Sao Paolo

number of design methods and tools now exist to facilitate analysis and calculations for piled rafts. It is to be hoped that these positive aspects will assist foundation design engineers to overcome the obstacles, and that piled rafts will become a more commonly employed foundation type.

ACKNOWLEDGEMENTS

The author is grateful to Dr John Small, of the University of Sydney, for many fruitful discussions on methods of analysis, Professor W. van Impe for his leadership in focusing the efforts of Technical Committee TC18 of the International Society of Soil Mechanics and Foundation Engineering in the period 1994–7 towards piled rafts, Professor Michael O’Neill for his contributions to the collection of case histories, and Professor Luciano Decourt, who provided the author with the opportunity to be involved with the project in Sao Paulo.

REFERENCES

Anagnostopoulos, C. & Georgiadis, M. (1998). A simple analysis of piles in raft foundations. *Geotech. Engng* **29**, No. 1, 71–83.

Burland, J. B. (1995). Piles as settlement reducers. *18th Italian Cong. Soil Mech., Pavia*.

Burland, J. B., Broms, B. B. & de Mello, V. F. B. (1977). Behaviour of foundations and structures. *Proc. 9th Int. Conf. Soil Mech. Found. Engng, Tokyo* **2**, 495–546.

Butterfield, R. & Banerjee, P. K. (1971). The elastic analysis of compressible piles and pile groups. *Géotechnique* **21**, No. 1, 43–60.

Clancy, P. & Randolph, M. F. (1993). Analysis and design of piled raft foundations. *Int. J. NAM Geomech.*

Cooke, R. W., Bryden Smith, D. W., Gooch, M. N. & Sillet, D. F. (1981). Some observations on the foundation loading and settlement of a multi-storey building on a piled raft foundation in London. *Proc. Inst. Civ. Engrs* **107**, Pt 1, 433–460.

Davis, E. H. & Poulos, H. G. (1972). The analysis of piled raft systems. *Aust. Geomech. J.* **2**, 21–27.

Decourt, L. (1989). SPT: state of the art report. *Proc. 12th Int. Conf. Soil Mech. Found. Engng, Rio de Janeiro* **4**, ???–???

Decourt, L. (1995). Predictions of load–settlement relationships for foundations on the basis of SPT-T. *Ciclo de Conf. Int. ‘Leonardo Zeevaert’*, UNAM, Mexico, pp. 85–104.

Desai, C. S. (1974). Numerical design analysis for piles in sands. *J. Geotech. Engng Div., ASCE* **100**, No. GT6, 613–635.

El-Mossallamy, Y. & Franke, E. (1997). *Piled rafts: numerical modelling to simulate the behaviour of piled raft foundations*. Darmstadt: the authors.

Fleming, W. G. K., Weltman, A. J., Randolph, M. F. & Elson, W. K. (1992). *Piling engineering*, 2nd edn. Surrey University Press.

Franke, E. (1991). Measurements beneath piled rafts. *ENPC Conference, Paris*, pp. 1–28.

Franke, E., Lutz, B. & El-Mossallamy, Y. (1994). *Measurements and numerical modelling of high-rise building foundations on Frankfurt Clay*, Geotechnical Special Publication 40, pp. 1325–1336. New York: American Society of Civil Engineers.

Fraser, R. A. & Wardle, L. J. (1976). Numerical analysis of rectangular rafts on layered foundations. *Géotechnique* **26**, No. 4, 613.

Hain, S. J. & Lee, I. K. (1978). The analysis of flexible raft–pile systems. *Géotechnique* **28**, No. 1, 65–83.

Hansbo, S. (1993). Interaction problems related to the installation of pile groups. *Proceedings of the seminar on deep foundations on bored and auger piles*, Ghent, pp. 59–66.

Hooper, J. A. (1973). Observations on the behaviour of a piled-raft foundation on London Clay. *Proc. Inst. Civ. Engrs* **55**, No. 2, 855–877.

Hooper, J. A. (1974). *Review of behaviour of piled raft foundations*, Report No. 83. London: CIRIA.

Horikoshi, K. & Randolph, M. F. (1998). A contribution to the optimum design of piled rafts. *Géotechnique* **48**, No. 2, 301–317.

Katzenbach, R., Arslan, U., Moorman, C. & Reul, O. (1998). Piled raft foundation: interaction between piles and raft. *Darmstadt Geotechnics* (Darmstadt University of Technology), No. 4, 279–296.

Kuwabara, F. (1989). An elastic analysis for piled raft foundations in a homogeneous soil. *Soils Found.* **28**, No. 1, 82–92.

Lee, I. K. (1993). Analysis and performance of raft and raft–pile foundations in a homogeneous soil. *Proc. 3rd Int. Conf. Case Hist. in Geotech. Engng, St Louis* (also Research Report R133, ADAF, University of New South Wales, Australia).

Mayne, P. W. & Poulos, H. H. (1999). Approximate displacement influence factors for elastic shallow foundations. *J. Geotech. Geoenviron. Engng* **125**, No. 6, 453–460.

O’Neill, M. W., Caputo, V., De Cock, F., Hartikainen, J. & Mets, M. (1996). *Case histories of pile-supported rafts*, Report for ISSMFE Technical Committee TC18. Houston, TX: University of Houston.

Poulos, H. G. (1989). Pile behaviour: theory and application. *Géotechnique* **39**, No. 3, 365–415.

Poulos, H. G. (1990). *DEFPIG users’ manual*. University of Sydney, Australia.

Poulos, H. G. (1991). In *Computer methods and advances in geomechanics* (eds Beer *et al.*), pp. 183–191. Rotterdam: Balkema.

Poulos, H. G. (1993). Piled rafts in swelling or consolidating soils. *Jnl. Geotechnical Div., ASCE*, **119**(2), 374–380.

Poulos, H. G. (1994a). An approximate numerical analysis of pole–raft interaction. *Int. J. NAM Geomech.* **18**, 73–92.

Poulos, H. G. (1994b). Alternative design strategies for piled raft foundations. *Proc. 3rd Int. Conf. Deep Foundations, Singapore*, 239–244.

Poulos, H. G. & Davis, E. H. (1980). *Pile foundation analysis and design*. New York: Wiley.

Poulos, H. G., Small, J. C., Ta, L. D., Sinha, J. & Chen, L. (1997). Comparison of some methods for analysis of piled rafts. *Proc. 14th Int. Conf. Soil Mech. Found. Engng, Hamburg* **2**, 1119–1124.

Price, G. & Wardle, I. F. (1986). Queen Elizabeth II Conference Centre: monitoring of load sharing between piles and raft. *Proc. Inst. Civ. Engrs* **80**, No. 1, 1505–1518.

Randolph, M. F. (1983). *Design of piled foundations*, Research Report Soils TR143. Cambridge: Cambridge University Engineering Department.

Randolph, M. F. (1994). Design methods for pile groups and piled rafts: state-of-the-art report. *Proc. 13th Int. Conf. Soil Mech. Found. Engng, New Delhi* **5**, 61–82.

Russo, G. & Viggiani, C. (1998). Factors controlling soil–structure interaction for piled rafts. *Darmstadt Geotechnics* (Darmstadt University of Technology), No. 4, 297–322.

Selvadurai, A. P. S. (1979). Elastic analysis of soil–foundation interaction. In *Developments in geotechnical engineering Vol. 17*. Amsterdam: Elsevier.

Sinha, J. (1996). Analysis of piles and piled rafts in swelling and shrinking soils. PhD Thesis, Univ. of Sydney, Australia.

Sinha, J. (1997). *Piled raft foundations subjected to swelling and shrinking*. PhD thesis, University of Sydney, Australia.

Sinha, J. & Poulos, H. G. (1999). Piled raft systems and free-standing pile groups in expansive soils. *Proc. 8th Aust.-New Zealand Cong. Geomech., Hobart* **1**, 207–212.

Sommer, H., Wittman, P. & Ripper, P. (1985). Piled raft foundation of a tall building in Frankfurt Clay. *Proc. 11th Conf. Soil Mech. Found. Engng, San Francisco* **4**, 2253–2257.

Sommer, H., Tamaro, G. & DeBenedittis, C. (1991). Messe Turm, foundations for the tallest building in Europe. *Proc. 4th DFI Conf, Stresa*, 139–145.

Ta, L. D. & Small, J. C. (1996). Analysis of piled raft systems in layered soils. *Int. J. NAM Geomech.* **2**, 57–72.

Tamaro, G. J. (1996). *Foundation engineers: why do we need them?* 1996 Martin S. Kapp Lecture. New York: American Society of Civil Engineers.

van Impe, W. F. & Lungu, I. (1996). *Technical report on settlement prediction methods for piled raft foundations*. Ghent University, Belgium.

Viggiani, C. (1998). Pile groups and piled rafts behaviour. In *Deep foundations on bored and auger piles* (eds van Impe & Haegman), pp. 77–90. Rotterdam: Balkema.

Wang, A. (1995). Private communication from PhD thesis, University of Manchester, UK.

Yamashita, K., Yamada, T. and Kakurai, M. (1998). Simplified method for analysing piled raft foundations. *Deep Foundations on Bored and Auger Piles*, Ed. W. F. van Impe, Balkema, Rotterdam, 457–464.

Yamashita, K., Kakurai, M. and Yamada, T. (1994). Investigation of a piled raft foundation on stiff clay. *Proc. 13th Int. Conf. Soil Mech. Found. Eng.*, New Delhi, **2**, 543–546.

Zeevaert, L. (1957). Compensated friction-pile foundation to reduce the settlement of buildings on highly compressible volcanic clay of Mexico City. *Proc. 4th Int. Conf. Soil Mech. Found. Engng, London* **2**.

Zhuang, G. M., Lee, I. K. & Zhao, X. H. (1991). Interactive analysis of behaviour of raft-pile foundations. *Proc. Geo-Coast ’91, Yokohama* **2**, 759–764.