

# Control of a wind energy conversion system equipped by a DFIG for active power generation and power quality improvement

M. Boutoubat<sup>a</sup>, L. Mokrani<sup>a,\*</sup>, M. Machmoum<sup>b</sup>

<sup>a</sup>Electrical Engineering Department, Laghouat University, Ghardaia street, Bp 37 G, Laghouat 03000, Algeria

<sup>b</sup>IREENA, 37 Boulevard de l'Université, Bp 406, 44602 Saint-Nazaire, Nantes, France

## ARTICLE INFO

### Article history:

Received 3 December 2011

Accepted 30 June 2012

Available online 31 July 2012

### Keywords:

Variable speed wind turbine

AC-DC-AC PWM converter

Harmonic currents

Active filtering

Reactive power compensation

Power quality

## ABSTRACT

The aim of this paper is to improve the reactive power compensation and active filtering capability of a Wind Energy Conversion System (WECS). The proposed algorithm is applied to a Doubly Fed Induction Generator (DFIG) with a stator directly connected to the grid and a rotor connected to the grid through a back-to-back AC-DC-AC PWM converter. The control strategy of the Rotor Side Converter (RSC) aims, at first, to extract a maximum of power under fluctuating wind speed. Then, depending on the rate power of the RSC, the power quality can be improved by compensating the reactive power and the grid harmonics current due to nonlinear loads. Hence, the RSC is controlled in order to manage the WECS function's priorities, between production of the maximum active power captured from the wind, and power quality improvement. The main goal of the proposed control strategy is to operate the RSC at its full capacity, without any over-rating, in terms of reactive power compensation and active filtering capability. Elsewhere, the Grid Side Converter (GSC) is controlled in such a way to guarantee a smooth DC voltage and ensure sinusoidal current in the grid side. Simulation results show that the wind turbine can operate at its optimum power point for a wide range of wind speed and power quality can be improved. It has been shown also that the proposed strategy allows an operating full capacity of the RSC in terms of reactive power compensation and active filtering.

© 2012 Elsevier Ltd. All rights reserved.

## 1. Introduction

Due to its clean and renewable nature, wind energy is becoming one of the important renewable sources of energy in the world. Through its collaboration with other renewable sources of energy, such as solar energy, the world energy crises can be solved in the future [1]. Comparatively with the past and due to the progressive integration of the nonlinear loads in the grid, the principal role of a WECS is not only to capture the maximum power from the wind but, also, to improve the quality of power [1]. Consequently, with the development of the wind farms which are integrated in the grid, power quality could be better improved in the future. Variable speed wind generators are frequently used and are more attractive than fixed-speed systems because of their efficient energy production, improved power quality and dynamic performance during grid faults. Recently, the most of the wind energy conversion systems are equipped with a variable speed DFIG [2]. Many works

are done about power generation and power quality improvement using a WECS. In [1,2], Gaillard et al., have studied the grid reactive power compensation and active filtering of the nonlinear loads harmonics by controlling the RSC. In this work a selective pass band filter is used to extract harmonic current components with taking advantage of the high amplification effect of the RSC to mitigate harmonic currents. In [3], a sensorless field oriented control of a doubly fed induction electric alternator/active filter for WECS capable of simultaneously capturing maximum variable wind power and improving power quality by eliminating the most significant and trouble-some harmonic currents of nonlinear loads has been studied. In this contribution, reactive power compensation and over-rating of the RSC are not discussed. In [4], the GSC is used as a shunt active filter in order to control the power factor and ensure harmonics compensation. In [5], Jain et al. have used the GSC as a shunt active filter in a stand-alone grid. In [6], the grid side converter is actively controlled to feed generated power as well as to supply the harmonics and reactive power demanded by the nonlinear load at the point of common coupling (PCC). In [7], Chen et al. have studied reactive power and harmonic compensation schemes including passive filters, active filters and hybrid compensation

\* Corresponding author. Tel.: +213 773932627; fax: +213 29932698/29932109.

E-mail addresses: [boutoubat90@yahoo.fr](mailto:boutoubat90@yahoo.fr) (M. Boutoubat), [mokrani\\_lakhdar@hotmail.com](mailto:mokrani_lakhdar@hotmail.com) (L. Mokrani), [mohamed.machmoum@univ-nantes.fr](mailto:mohamed.machmoum@univ-nantes.fr) (M. Machmoum).

Nomenclature			
$v$	Wind speed (m/s)	$M$	Magnetizing inductance (H)
$V_g$	PCC voltage (V)	$R_s, R_r$	Stator and rotor per phase winding resistance ( $\Omega$ )
$i_r$	Rotor current (A)	$R_g$	Line resistance ( $\Omega$ )
$i_p$	Linear load current (A)	$L_g$	Line inductance (H)
$i_l$	Nonlinear load current (A)	$C$	DC bus capacitor (F)
$i_G$	Grid current (A)	$J$	Total inertia constant (DFIG and turbine) ( $\text{kg m}^2$ )
$\psi_s$	Stator flux (Wb)	$f$	Total friction factor (DFIG and turbine) ( $\text{Nm s}$ )
$T_{em}$	Electromagnetic torque (Nm)	$\omega_s$	Synchronous angular speed (rd/s)
$T_L$	Turbine torque (Nm)	$\omega_r$	Rotor angular speed (rd/s)
$P_s, Q_s$	Stator active (W) and reactive (VAR) powers	$\omega_t$	Turbine speed (rd/s)
$Q_{PCC}$	PCC reactive power (VAR)	$\Omega_g$	DFIG speed (rd/s)
$L_s, L_r$	Stator and rotor per phase winding inductance (H)	$\delta$	Gear box ratio
		$R$	Turbine radius (m)
		$P$	Pole pairs number

methods for a converter interfaced with permanent magnet generator based variable speed wind turbine. In [8], Engelhardt et al. have discussed the steady state reactive power loading capability of DFIG based WECS by tacking into account the most important physical phenomena restricting the reactive power supply of DFIG-based wind turbine systems. In [9], Different combinations of reactive power control of RSC and GSC are investigated for DFIG. In [10], Machmoum et al. have studied flicker mitigation in a doubly fed induction generator for wind turbine system based on RSC control. In general, the full capacity of the RSC, in terms of active filtering, has not been exploited for different operating conditions of the WECS.

In this paper, a control strategy is proposed to achieve the filtering full capability of the RSC which is used to manage the WECS function's priorities, between production of the maximum active power and power quality improvement. The top priority is given to the active power production over power quality improvement. Then, priority is given to power factor correction over harmonics compensation. Finally, the filtering capability of the RSC is exploited at its maximum (when it is needed) without any over-rating by using a proposed procedure. Moreover, the GSC is controlled in such a way to guarantee a smooth DC voltage by using a fuzzy logic controller. A sinusoidal current is ensured between GSC and the grid.

## 2. Description and modelling of the wind energy conversion system

The synoptic scheme of the studied system is shown in Fig. 1. It is composed of a WECS, a linear load and a nonlinear load. These elements are coupled together at the PCC.

### 2.1. Turbine model

The mechanical power captured by the turbine from the wind is given by the following expression:

$$p_t = \frac{1}{2} \rho c_p(\lambda, \beta) s v^3 \tag{1}$$

Where  $\rho$  is the air density,  $s$  is the area of the wind wheel ( $\text{m}^2$ ),  $v$  is the wind speed (m/s),  $c_p(\lambda, \beta)$  is the power coefficient of the turbine,  $\lambda$  is the tip speed ratio and  $\beta$  is the pitch angle.

The tip speed ratio is given by the following equation:

$$\lambda = \frac{R\omega_t}{v} \tag{2}$$

Fig. 2 shows the variation of the power coefficient versus  $\lambda$  for a constant value of the pitch angle  $\beta$ . In the case of a variable speed

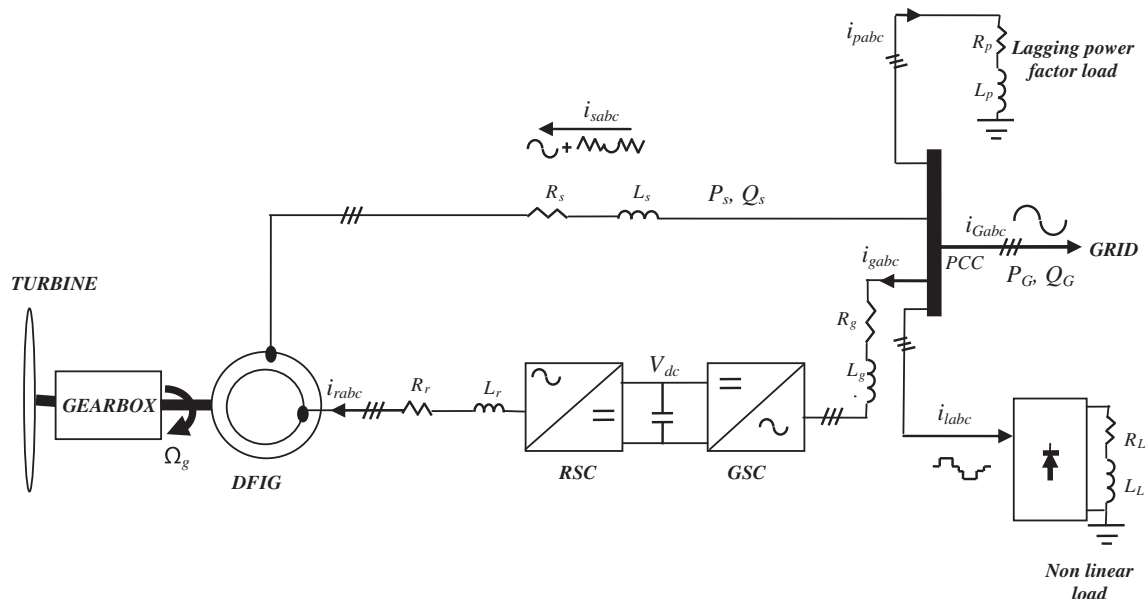

Fig. 1. Synoptic scheme of the studied WECS.

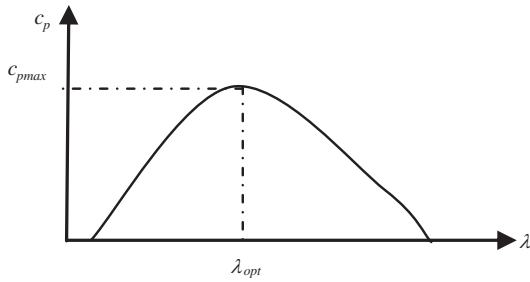

Fig. 2. Power coefficient versus the tip speed.

WECS, one can let  $\omega_t$  change with the variation of the wind speed  $v$  in order to maintain  $\lambda$  at its optimal value  $\lambda_{opt}$  (see Fig. 2), so that the turbine blade can capture the maximum of the wind power.

## 2.2. Modelling of the DFIG with stator field orientation

The DFIG voltage and flux equations, expressed in the Park reference frame, are given by [11]:

$$\begin{aligned} u_{ds} &= R_s i_{ds} + \frac{d\psi_{ds}}{dt} - \omega_s \psi_{qs} \\ u_{qs} &= R_s i_{qs} + \frac{d\psi_{qs}}{dt} + \omega_s \psi_{ds} \\ u_{dr} &= R_r i_{dr} + \frac{d\psi_{dr}}{dt} - (\omega_s - \omega_r) \psi_{qr} \\ u_{qr} &= R_r i_{qr} + \frac{d\psi_{qr}}{dt} + (\omega_s - \omega_r) \psi_{dr} \end{aligned} \quad (3)$$

$$\begin{aligned} \psi_{ds} &= L_s i_{ds} + M i_{dr} \\ \psi_{qs} &= L_s i_{qs} + M i_{qr} \\ \psi_{dr} &= L_r i_{dr} + M i_{ds} \\ \psi_{qr} &= L_r i_{qr} + M i_{qs} \end{aligned} \quad (4)$$

Moreover, the electromagnetic torque is given by:

$$T_{em} = 1.5p(i_{qs}\psi_{ds} - i_{ds}\psi_{qs}) \quad (5)$$

Elsewhere, the mechanical dynamic equation is expressed as follow:

$$T_{em} = J \frac{d\Omega_g}{dt} + f\Omega_g + T_L \quad (6)$$

The stator resistance of the DFIG is neglected and the stator flux  $\psi_s$  is set aligned with the  $d$  axis and assumed to be constant (it is the case of a powerful and stable grid) [12].

Then, one can write  $\psi_{ds} = \psi_s$  and  $\psi_{qs} = 0$ . Consequently, Equations (3)–(5) become respectively in the steady state regime:

$$u_{ds} \approx 0 \quad (7.a)$$

$$u_s = u_{qs} \approx \omega_s \psi_s \quad (7.b)$$

$$\psi_s = L_s i_{ds} + M i_{dr} \quad (8.a)$$

$$0 = L_s i_{qs} + M i_{qr} \quad (8.b)$$

$$T_{em} = -\frac{3}{2} p \frac{M}{L_s} \psi_s i_{qr} \quad (9)$$

Hence, the rotor voltage equations can be written as follow [13]:

$$u_{dr} = R_r i_{dr} + \left(L_r - \frac{M^2}{L_s}\right) \frac{di_{dr}}{dt} - g\omega_s \left(L_r - \frac{M^2}{L_s}\right) i_{qr} \quad (10)$$

$$u_{qr} = R_r i_{qr} + \left(L_r - \frac{M^2}{L_s}\right) \frac{di_{qr}}{dt} + g\omega_s \left(L_r - \frac{M^2}{L_s}\right) i_{dr} + g \frac{Mu_s}{L_s}$$

Where  $u_s$  is the stator voltage magnitude assumed to be constant and  $g$  is the slip range.

Moreover, the stator active and reactive powers are expressed by the following equations:

$$P_s = \frac{3}{2} (u_{ds} i_{ds} + u_{qs} i_{qs}) \quad (11)$$

$$Q_s = \frac{3}{2} (u_{qs} i_{ds} - u_{ds} i_{qs}) \quad (12)$$

Equations (7.a), (7.b), (8.a) and (8.b) are used to rewrite the stator active and reactive powers as follow:

$$P_s = -\frac{3u_s M}{2L_s} i_{qr} \quad (13)$$

$$Q_s = \frac{3}{2} \frac{u_s}{L_s \omega_s} (u_s - M\omega_s i_{dr}) \quad (14)$$

## 2.3. Rotor side converter control

In this work, the issues which need to be addressed by the RSC control are:

- Capture of maximum energy from the wind (MPPT);
- Power quality improvement, through power factor enhancement and harmonics current filtering.

### 2.3.1. Maximum power generation

From Equation (9), one can establish that the electromagnetic torque can be controlled directly by acting on  $i_{qr}$  current component. Then, the  $q$ -reference rotor current is given by:

$$i_{qrref} = -\frac{2L_s \omega_s}{3pu_s M} T_{emref} \quad (15)$$

From Equation (14), one can note that the stator reactive power can be controlled by acting on  $i_{dr}$ . Then, the  $d$ -reference rotor current is given by:

$$i_{drref} = \frac{2L_s}{3u_s M} \left( \frac{3u_s^2}{2L_s \omega_s} - Q_{sref} \right) \quad (16)$$

To ensure the MPPT, a fuzzy logic speed controller (FLC) has been used (see Fig. 3).

Furthermore, to extract a maximum of power from the wind, the generator speed command is estimated by the following equation:

$$\Omega_{gref} = \delta \frac{\lambda_{opt}}{R} v \quad (17)$$

With  $\delta$  is the gear box ratio and  $\lambda_{opt}$  is the optimum tip speed ratio.

To control the RSC, the reference  $i_{qrref}$  (see Fig. 3) is derived from the speed error  $e$  and its variation  $\Delta e$  by tuning the FLC. Also, to control the reactive power to a desired value, a command current  $i_{drref}$  is derived from Equation (16), as shown in Fig. 3. Elsewhere, to

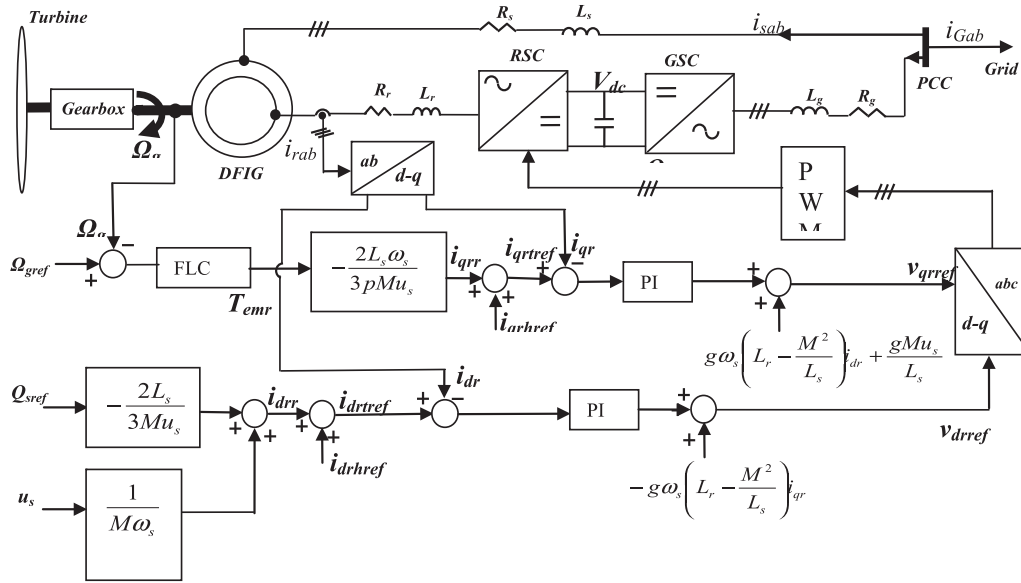

Fig. 3. Control scheme of the RSC for power generation and harmonic mitigation.

design the current control loops along the two axes, Equation (10) was used. The cross coupling terms between the  $d$ -axis and  $q$ -axis can be eliminated by a feed forward compensation. Thereby the independent control of the  $d$ -axis and  $q$ -axis rotor currents is realised by adding a PI regulator in the loop, as shown in Fig. 3.

### 2.3.2. Active filtering function

There are various methods that can be used to identify the harmonic reference currents. These methods can be essentially classified in two parts: the time domain and the frequency domain [14–16]. There are also two possibilities to control the harmonics in a selective way. On the one hand, the desired specific harmonic currents are first selected and imposed to a current controller having a large bandwidth, and on the other hand, a selective current controller (resonant current controller or generalized integrator) is directly used to regulate inherently specific harmonic components [17–20]. The most classical method is called “instantaneous power  $p$ – $q$  theory” [14] which can easily be extended to selective harmonic current compensation. In our case, the instantaneous power theory is used as shown in Fig. 4. The resulting  $d$ – $q$  harmonic reference currents  $i_{ldh}$ ,  $i_{lqh}$  are converted to their equivalent reference rotor currents  $i_{drhref}$ ,  $i_{qrhref}$  using Equations (8.a) and (8.b). The resulting equations are:

$$i_{drhref} = -\frac{L_s}{M}i_{ldh} \quad (18)$$

$$i_{qrhref} = -\frac{L_s}{M}i_{lqh}$$

For being compensated, the reference  $d$ – $q$  harmonic rotor currents must be taken by an opposite sign of  $i_{drhref}$ ,  $i_{qrhref}$ . So, the resulting harmonic rotor current commands that must be added to the active ( $i_{qrref}$ ) and the reactive ( $i_{drref}$ ) rotor current commands are given by (see Fig. 3):

$$i_{drhref1} = \frac{L_s}{M}i_{ldh} \quad (19)$$

$$i_{qrhref1} = \frac{L_s}{M}i_{lqh}$$

### 2.4. Power quality improvement

Due to the integration of nonlinear loads in the grid, the main role of a WECS is not only to capture the maximum power from the wind, but also to participate in power quality improvement.

#### 2.4.1. Active and reactive power capabilities of the RSC

To avoid the over-rating of the RSC during its control for both MPPT power generation and power quality improvement, it is required to know its active and reactive powers capabilities. By using Equations (13) And (14), the following expression, which describes the RSC active and reactive powers limits, is easily obtained:

$$P_s^2 + \left(Q_s + \frac{3u_s^2}{2L_s\omega_s}\right) = \left(\frac{3u_s M}{2L_s}I_{rm}\right)^2 \quad (20)$$

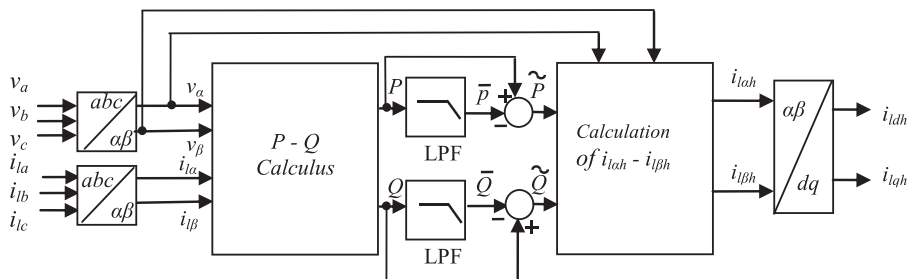

Fig. 4. Extraction of the harmonic components with instantaneous power algorithm.

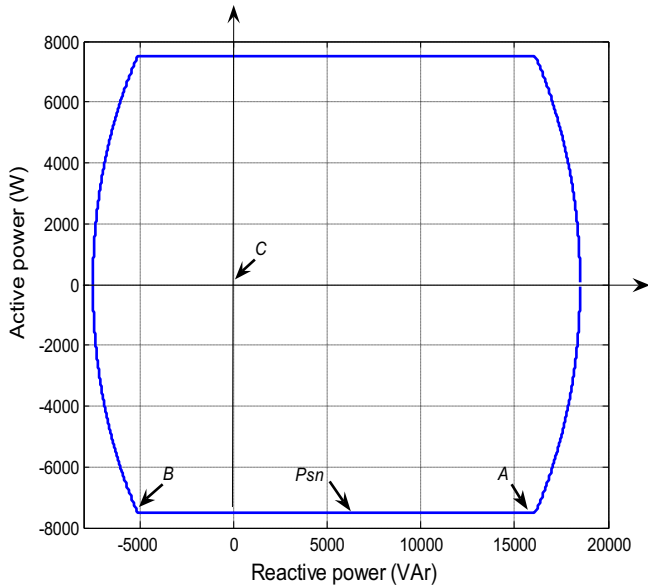

Fig. 5. Power limitations of the RSC.

Fig. 5 shows this equation which is a circle centred at the point C, where  $I_{rn}$  and  $P_{sn}$  are respectively the rated rotor current and the rated stator power. The line AB represents the  $P_s$ - $Q_s$  limitations at the nominal operating point (see Fig. 5).

2.4.2. Management of WECS function's priorities

The capability of the RSC in terms of power is limited by its nominal rotor current  $I_{rn}$ . The first priority is given to active power production over power quality improvement. Thus, the maximum value of the available reactive rotor current to be used for reactive

power compensation and harmonic currents mitigation is calculated from the following equation [1]:

$$I_{drmax} = \sqrt{I_{rn}^2 - i_{qrref}^2} \tag{21}$$

In order to exploit the RSC at its maximum capability in terms of power, it is proposed in this paper to express the total rotor current commands for active power production, reactive power compensation and harmonic mitigation by the following equations:

$$\begin{aligned} i_{drtref} &= i_{drref} + K_0 i_{drhref1} \\ i_{qrtref} &= i_{qrref} + K_0 i_{qrhref1} \end{aligned} \tag{22}$$

Where,  $K_0$  is a positive gain which can vary between 0 and 1.

Then, the second priority is given to compensate the reactive power over harmonic mitigation. Hence, one can write:

(a) First, if the reactive rotor command  $i_{drref}$  verifies:

$$|i_{drref}| \geq I_{drmax} \tag{23}$$

Then, the RSC operates at its full capacity in terms of power, and only active power production and reactive power compensation are practically possible (i.e.  $K_0 = 0$ ). And the total rotor current commands are given by:

$$\begin{aligned} i_{drtref} &= \text{sign}(i_{drref}) I_{drmax} \\ i_{qrtref} &= i_{qrref} \end{aligned} \tag{24}$$

(b) Second, if the reactive rotor current command  $i_{drref}$  verifies:

$$|i_{drref}| < I_{drmax} \tag{25}$$

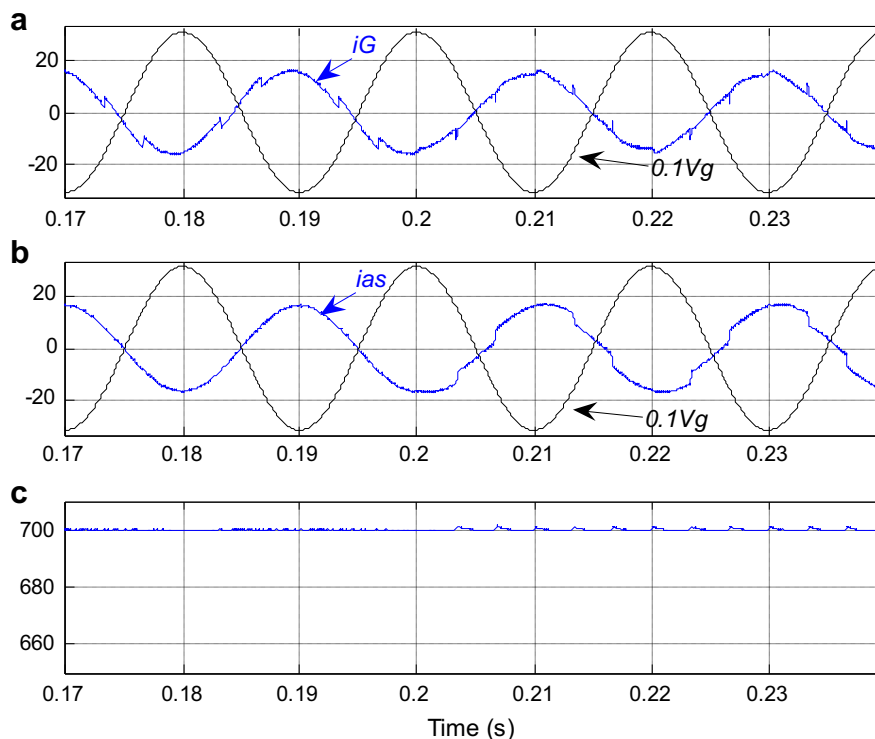
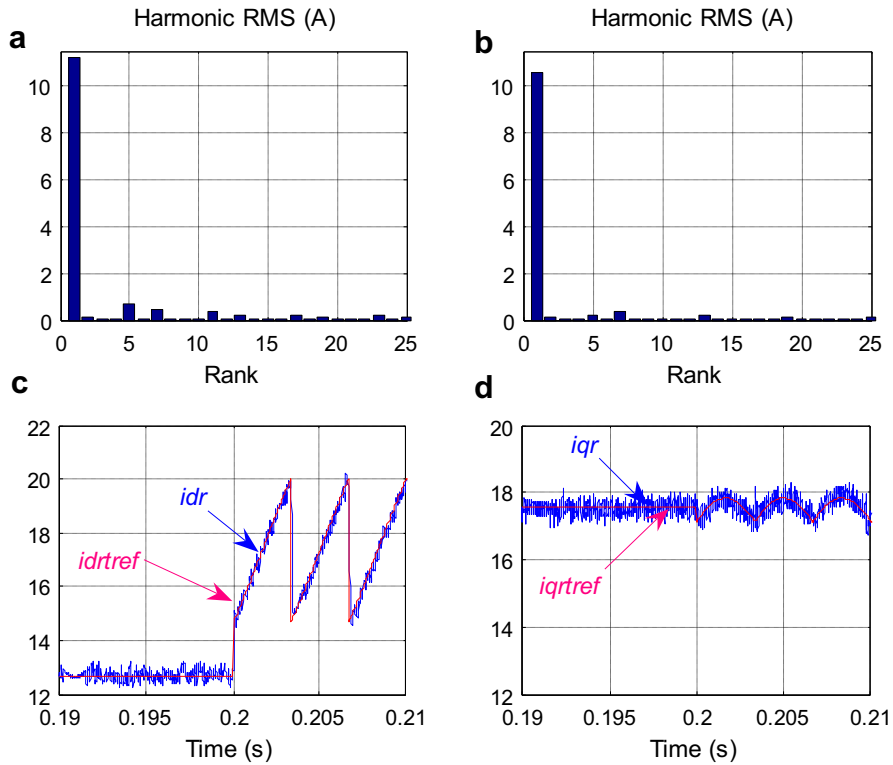
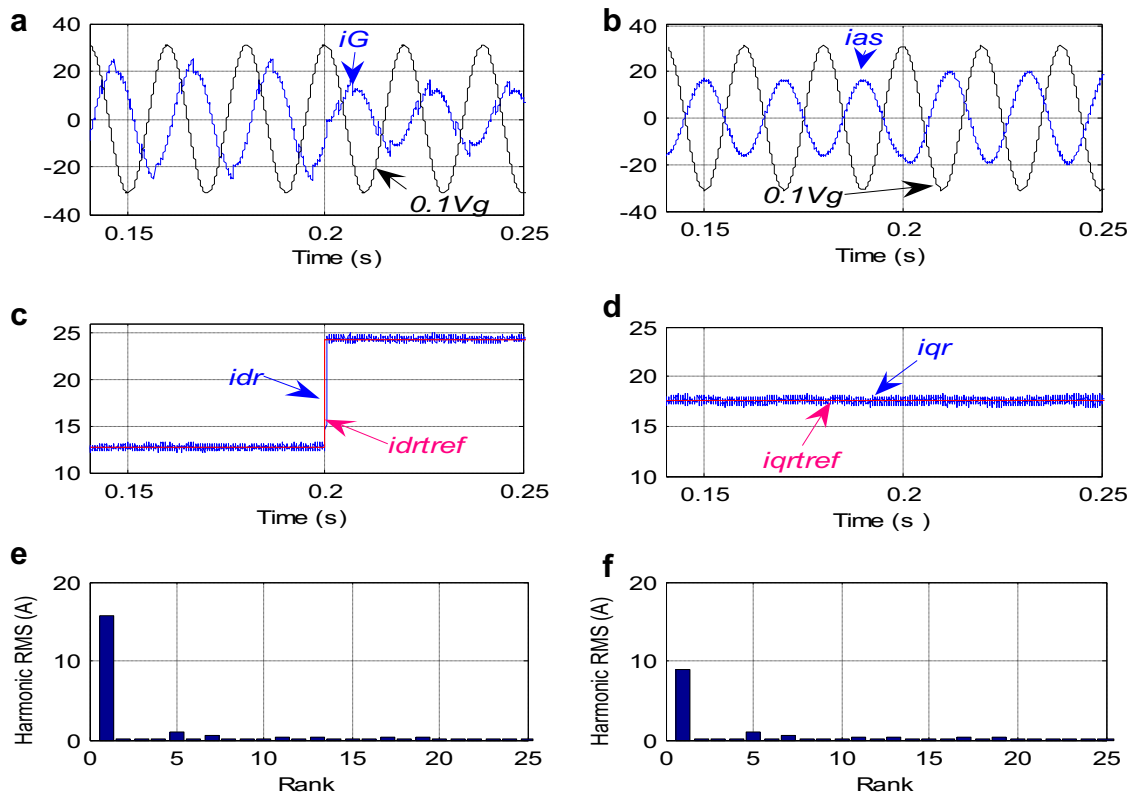

Fig. 6. Waveforms before and after compensation at  $t = 0.2$  s: a) Grid current ( $i_G$ ) (A) and PCC voltage ( $0.1V_g$ ) (V), b) Stator current ( $i_{as}$ ) (A) and PCC voltage ( $0.1V_g$ ) (V), c) DC voltage (V).



**Fig. 7.** Waveforms before and after compensation at  $t = 0.2$  s: a) Grid current spectrum before compensation, b) Grid current spectrum after compensation, c)  $d$ -rotor current and its command, d)  $q$ -rotor current and its command.



**Fig. 8.** Waveforms before and after compensation at  $t = 0.2$  s under reactive saturated rotor current command: a) Grid current ( $i_g$ ) (A) and PCC voltage ( $0.1V_g$ ) (V), b) Stator current ( $i_{as}$ ) (A) and PCC voltage ( $0.1V_g$ ) (V), c)  $d$ -rotor current and its command, d)  $q$ -rotor current and its command, e) Grid current spectrum before compensation, f) Grid current spectrum after compensation.

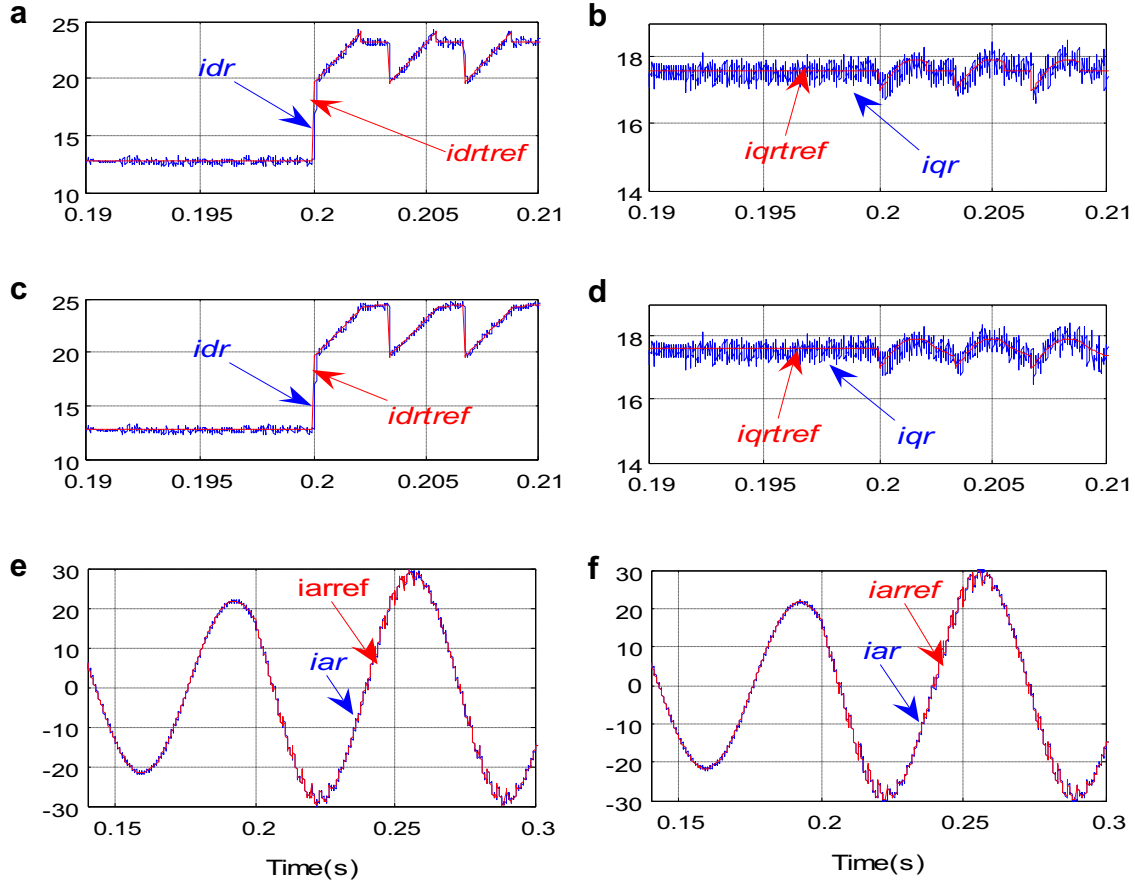

**Fig. 9.** Waveforms before and after compensation at  $t = 0.2$  s under harmonic saturated rotor current command, a)  $d$ -rotor current and its command for the first strategy, b)  $q$ -rotor current and its command for the first strategy, c)  $d$ -rotor current and its command for the second strategy, d)  $q$ -rotor current and its command for the second strategy, e) Instantaneous rotor current ( $i_{ar}$ ) (A) and its reference for the first strategy, f) Instantaneous rotor current ( $i_{ar}$ ) (A) and its reference for the second strategy.

Then there is a portion of reactive rotor current to be used for harmonic filtering. Two cases can be studied:

(b.1) The first case occurs when we have:

$$\left(i_{drref} + i_{drhref1}\right)^2 + \left(i_{qrref} + i_{qrhref1}\right)^2 \leq I_m^2 \quad (26)$$

In this case, the RSC can be used for both reactive power compensation and total harmonic current filtering (i.e.  $K_0 = 1$ ) without its over-rating. Consequently, the total rotor current commands are expressed by the following equations:

$$\begin{aligned} i_{drtref} &= i_{drref} + i_{drhref1} \\ i_{qrtref} &= i_{qrref} + i_{qrhref1} \end{aligned} \quad (27)$$

(b.2) The second case verifies:

$$\left(i_{drref} + i_{drhref1}\right)^2 + \left(i_{qrref} + i_{qrhref1}\right)^2 > I_m^2 \quad (28)$$

In this situation, the RSC can be used to compensate the total reactive power and to filter a portion of harmonic currents without its over-rating. To avoid any over-rating of the converter, two approaches can be investigated:

- In the first strategy, the harmonic filtering operation is omitted (since the whole of the harmonic currents can't be compensated) and only the power factor improvement is considered, i.e. the total  $d$ - $q$  rotor current commands are expressed by

Equation (22) with  $K_0 = 0$  [1]. In this case, the RSC is not operated at its full capacity in terms of active filtering.

- The second approach (which is proposed in this paper), permits to exploit the RSC full capability in terms of power, by filtering a portion of harmonic current without any over-rating. For this purpose, it is proposed to determine an appropriate gain  $K_{0m}$  ( $0 < K_{0m} < 1$ ) which verifies the following equation:

$$\left(i_{drref} + K_{0m}i_{drhref1}\right)^2 + \left(i_{qrref} + K_{0m}i_{qrhref1}\right)^2 = I_m^2 \quad (29)$$

The physical value of  $K_{0m}$  can be found by solving this second order equation. As a result, the total rotor current commands are expressed as follow:

$$\begin{aligned} i_{drtref} &= i_{drref} + K_{0m}i_{drhref1} \\ i_{qrtref} &= i_{qrref} + K_{0m}i_{qrhref1} \end{aligned} \quad (30)$$

In this case, the selective filtering approach can be used also (to mitigate the most dominant low frequency harmonics currents) [1,3].

### 3. Simulation results and discussion

The proposed control strategy is applied to a WECS equipped with a 7.5 kW DFIG. The system parameters are given in the appendix. The switching frequency of the RSC and the GSC is chosen equal to 10 kHz. The performance of the WECS ancillary services is studied under the nominal stator active power

( $P_{sn} = 7.5$  kW) for a nominal wind speed of 13.3 m/s. The total load of the system is composed of a non-linear load (full bridge diode rectifier) and a lagging linear load ( $R_p L_p$ ) (see Fig. 1).

3.1. Reactive power compensation and harmonic mitigation in the case of a non-saturated rotor current command

In this section, the reactive power compensation and harmonic mitigation, without saturated rotor current commands, are studied. The considered non-linear load, coupled at the PCC, has a harmonic distortion ratio of about 29%, and the linear load reactive power to be compensated is of 2 kVAr. Figs. 6 and 7 show the simulation results. The first figure shows the currents waveforms and the DC capacitor voltage, before and after compensation at  $t = 0.2$  s. The waveforms: grid current ( $i_g$ ), PCC voltage ( $V_g$ ) and stator current ( $i_{as}$ ) show clearly the performance of the proposed strategy in terms of power quality improvement. After compensation and as can be remarked in Fig. 6(a), the grid current is in phase opposition (generator mode) with the PCC voltage, Hence a unity power factor has been achieved at the PCC. The DC capacitor voltage is maintained constant practically at its command value of 700 V, by the control of the GSC as shown in Fig. 6(c). During active filtering operation, one can notice small oscillations of  $V_{dc}$  at a frequency of 300 Hz. However, these oscillations do not affect the DC bus stability. As shown in Fig. 7(a–b), the grid current spectrum, before and after active filtering, prove the enhancement of the grid current THD which is reduced from about 9% to 4.7%. Consequently, the RMS of the 5th and the 7th harmonic components have been reduced from about 0.71 A to 0.2 A and from 0.46 A to 0.37 A respectively. Moreover, the instantaneous  $d$ – $q$  rotor currents track adequately their references (see Fig. 7(c–d)), in this case of maximum active power production, reactive power compensation and harmonic currents filtering.

3.2. Reactive power compensation and harmonic filtering in the case of a saturated rotor current command

As has been seen previously (see Section 2.4.2), the rotor current command limit could be reached due to the reactive power current command or to the harmonic current command. Those two situations of saturated rotor current command are studied in the following sections.

3.2.1. Case of a saturated rotor current command due to reactive power compensation

For the rated active power ( $P_{sn}$ ), the maximum value of the reactive power which can be compensated by the DFIG, is about 5 kVAr (point B in Fig. 5). To be under the condition of the saturated rotor current command, one can choose a linear load of a reactive power of about 9.5 kVAr and a non-linear load as that of Section 3.1. Fig. 8 illustrates the obtained simulation results before and after compensation at  $t = 0.2$  s. After compensation, the total rotor current commands are saturated ( $\sqrt{i_{drtref}^2 + i_{qrtref}^2} = 30A$ ) (see Fig. 8(c–d)) for only active power production and reactive power compensation. In this situation, the RSC operates at its full capacity, and therefore no harmonic currents filtering can be achieved without the converter over-rating. Moreover, only 5 kVAr from 9.5 kVAr of reactive power has been compensated. Consequently, the power factor is improved from about 0.37 to 0.63. Elsewhere, from the grid current spectrum, shown by Fig. 8(e–f), it has been deduced that the THD of the grid current is increased from about 6.2% to 10.4%. In fact, a portion of reactive power has been compensated without harmonic filtering, so that the fundamental value of the grid current decreased, and thus the THD increased. Note that, in this case, the RMS of the 5th and the 7th harmonic components has remained practically the same, before and after compensation, as can be seen in Fig. 8(e–f).

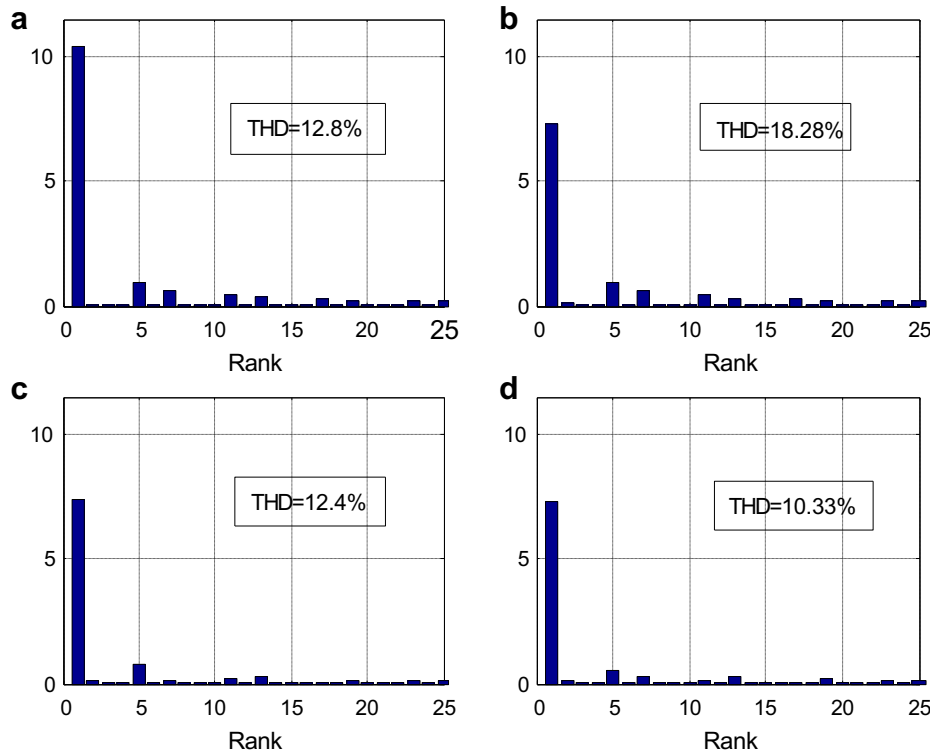

Fig. 10. Grid current spectrum before and after compensation at  $t = 0.2$  s under harmonic saturated rotor current command, a) Spectrum before compensation, b) spectrum after reactive power compensation only, c) spectrum after compensation using the first strategy, d) Spectrum after compensation using the second strategy.



### 3.2.2. Case of a saturated rotor current command due to harmonic filtering

To show the effectiveness of the proposed strategy which permits to exploit the full capability of the RSC in terms of active filtering, it has been chosen to compensate a reactive power of about 4.5 kVAr and to filter the harmonic currents of the same non-linear load of Section 3.1. In this case, the RSC can compensate the total reactive power because it is less than its upper limit (5 kVAr). So, a portion of 0.5 kVAr is available and can be used for active filtering. This quota of reactive power is not enough to compensate the whole harmonic currents without RSC over-rating. In this situation, as has been detailed previously (see Section 2.4.2), two approaches have been investigated.

Figs. 9 and 10 show the obtained simulation results, before and after compensation, in the two cases a) and b) of Section 2.4.2 respectively. By comparison of the  $d$ - $q$  rotor current components of the two strategies (see Fig. 9(a–d)), one can note, when the whole harmonic current can't be compensated, that the total  $d$ - $q$  rotor current commands are limited to ( $i_{drtref} = i_{drref} = 23.24$  A,  $i_{qrtref} = i_{qrref} = 17.59$  A) during about 0.2 ms, for the first strategy. During this time, the harmonic currents compensation has not been fully achieved and the full capacity of the converter has not been completely exploited. In the case of the second strategy, and during the same time, the  $d$ - $q$  rotor current commands are not constant and vary between 24.17 A and 24.47 A for  $i_{drtref}$  and between 17.85 A and 17.36 A for  $i_{qrtref}$ . And the optimum gain  $K_{Om}$  varies between 0.99 and 0.38, so that to keep the instantaneous rotor current lower than its rated value ( $I_m = 30$  A) as shown in Fig. 9(e–f) and any over-rating of the RSC has been happened. During this time, the full capability, in terms of active filtering, of the RSC has achieved without RSC over-rating.

Consequently, the grid current THD has been reduced from 12.8% to 12.4% and from 12.8% to 10.33% by applying the first and the second strategy respectively (see Fig. 10(a,c and d)). It is to be noted also that the grid current THD, in the case of simple reactive power compensation, is about 18.28% (see Fig. 10(b)). A comparison of the two strategies current THD shows that an important improvement, in terms of harmonic mitigation, is achieved by using the second strategy. In fact, the enhancement of the grid current THD is about 0.4% for the first strategy and 2.5% for the second. The significance and effectiveness of the proposed control strategy appears when the compensation of reactive power and active filtering are carried out by a set of wind park generators.

## 4. Conclusion

In this paper, a novel approach has been proposed to manage and improve the quality of the grid power using a WECS equipped by a DFIG. The RSC is controlled in such a way to manage between production of maximum active power and power quality improvement without any over-rating. The proposed priority control block gives top priority to active power production than power quality, and reactive power compensation has priority than active filtering. After active power production and power factor correction, the capability of the RSC is fully exploited for active filtering, without its over-rating; by the calculation of an appropriate portion of rotor current commands in such a way to ensure a better filtering quality and keep the RSC current under its rated value. Simulation results prove the effectiveness of the proposed approach. A selective filter can be used to compensate only the fifth and seventh most dominant harmonic currents, and guarantee a maximum capability of the RSC, in terms of active filtering, in the same way.

## Appendix

<i>Turbine parameters</i>	
Power (kW)	10
Number of blades	3
Turbine radius, $R$ (m)	3
Gear box ratio	8
<i>DFIG parameters</i>	
Power (kW)	7.5
Stator resistance, $R_s$ ( $\Omega$ )	0.455
Rotor resistance, $R_r$ ( $\Omega$ )	0.62
Stator phase inductance, $L_s$ (H)	0.084
Rotor phase inductance, $L_r$ (H)	0.081
Magnetizing inductance, $M$ (H)	0.078
Generator inertia, $J$ ( $\text{kg m}^2$ )	0.3125
Friction factor, $f$ (N m s)	0.00673

## References

- [1] Gaillard A, Poure P, Saadate S. Reactive power compensation and active filtering capability of WECS with DFIG without any over-rating. *Wind Energy* 2009;137:603–14.
- [2] Gaillard A, Poure P, Saadate S, Machmoum M. Variable speed DFIG wind energy system for power generation and harmonic mitigation. *Renewable Energy* 2009;346:1545–53.
- [3] Abolhassani MT, Enjeti P, Toliyat H. Integrated doubly fed electric alternator/active filter (IDEA), a viable power quality solution for wind energy conversion systems. *IEEE Transactions on Energy Conversion* 2008;232:642–50.
- [4] Singh M, Chandra A. Application of adaptive network-based fuzzy inference system for sensorless control of PMSG-based wind turbine with nonlinear-load-compensation capabilities. *IEEE Transactions on Power Electronics* 2011;261:165–75.
- [5] Jain AK, Ranganathan VT. Wound rotor induction generator with sensorless control and integrated active filter for feeding nonlinear loads in a stand-alone grid. *IEEE Transactions on Industrial Electronics* 2008;551:218–28.
- [6] Singh M, Khadkikar V, Chandra A. Grid synchronization with harmonics and reactive power compensation capability of a permanent magnet synchronous generator-based variable speed wind energy conversion system. *IET Power Electronics* 2011;41:122–30.
- [7] Chen Z. Compensation schemes for a SCR converter in variable speed wind power systems. *IEEE Transactions on Power Delivery* 2004;192:813–21.
- [8] Engelhardt S, Erlich I, Feltes C, Kretschmann J, Shewarega F. Reactive power capability of wind turbines based on doubly fed induction generators. *IEEE Transactions on Energy Conversion* 2011;261:364–72.
- [9] Kayikçi M, Milanovic J. Reactive power control strategies for DFIG-based plants. *IEEE Transactions on Energy Conversion* 2007;222:389–96.
- [10] Machmoum M, Hatoum A, Bouaouiche T. Flicker mitigation of a doubly-fed induction generator for wind energy conversion system. *Mathematics and Computers in Simulation* 2010;812:433–45.
- [11] Shahbazi M, Poore P, Saadate S, Zalghadri MR. Five-leg converter topology for wind energy conversion system with doubly fed induction generator. *Renewable Energy* 2011;3611:3187–94.
- [12] Soares O, Gonçalves H, Martins A, Carvalho A. Nonlinear control of the doubly-fed induction generator in wind power systems. *Renewable Energy* 2010;358:1662–70.
- [13] Poitiers F, Bouaouiche T, Machmoum M. Advanced control of a doubly-fed induction generator for wind energy conversion. *Electric Power Systems Research* 2009;797:1085–96.
- [14] Akagi H, Kanazawa Y, Nabae A. Instantaneous reactive power compensators comprising switching devices without storage components. *IEEE Transactions on Industrial Applications* 1984;203:625–30.
- [15] Massoud AM, Finny SJ, Williams BW. Review of harmonic current extraction techniques for an active power filter. *IEEE International Conference on Harmonics and Quality of Power, Lake Placid (USA)* 2004:154–9.
- [16] Blaabjerg F, Hansen S, Assiminoaeli L. Harmonic detection methods for active power filter applications. *IEEE Industry Applications Magazine* 2007;134:22–33.
- [17] Zmood DN, Holmes DG. Stationary frame harmonic reference generation for active filters systems. *IEEE Transactions on Industry Applications* 2002;386:1591–9.
- [18] Bojoi RI, Griva G, Bostan V, Guerriero M, Farina F, Profumo F. Current control strategy for power conditioners using sinusoidal signal integrator in synchronous reference frame. *IEEE Transactions on Power Electronics* 2005;206:1402–12.
- [19] Mattavelli P, Marafao FP. Repetitive-based control for selective harmonic compensation in active power filters. *IEEE Transactions on Industrial Electronics* 2004;515:1018–24.
- [20] Machmoum M, Bruyant N. DSP based control of shunt active power filters for global or selective harmonics compensation, *IEEE international conference on harmonics and quality of power*. Orlando, Florida (USA); 2000. p. 661–666.