

# An empirical study of DSRC V2V performance in truck platooning scenarios<sup>☆</sup>



Song Gao<sup>a,c</sup>, Alvin Lim<sup>a,c,\*</sup>, David Bevly<sup>b,c</sup>

<sup>a</sup> Department of Computer Science and Software Engineering, 3101 Shelby Center, U.S.

<sup>b</sup> Department of Mechanical Engineering, 2418F Wiggins Hall, U.S.

<sup>c</sup> Auburn University, Auburn, AL 36849, U.S.

## ARTICLE INFO

### Keywords:

Empirical study  
DSRC V2V performance  
Truck platooning  
Delivery ratio

## ABSTRACT

Among many safety applications enabled by Dedicated Short Range Communication (DSRC), truck platooning provides many incentives to commercial companies. This paper studies DSRC Vehicle-to-Vehicle (V2V) performance in truck platooning scenarios through real-world experiments. Commercial DSRC equipments and semi-trailer trucks are used in this study. We mount one DSRC antenna on each side of the truck. One set of dynamic tests and a few sets of static tests are conducted to explore DSRC behaviors under different situations. From the test results, we verified some of our speculations. For example, hilly roads can affect delivery ratio and antennas mounted on opposite sides of a truck can suffer from low delivery ratio at curved roads. In addition, we also found that antennas can sometimes suffer from low delivery ratio even when the trucks are on straight roads, possibly due to reflections from the nearby terrain. Fortunately, the delivery ratio can be greatly improved by using the two side antennas alternately.

## 1. Introduction

Dedicated Short Range Communication (DSRC), is a communication technology designed for vehicular environments. By utilizing wireless radio, DSRC allows vehicles to communicate with nearby vehicles and road-side units efficiently. Wireless device vendors have been actively developing chipsets and integrated modules that provides DSRC support. Integrated devices that not only provide DSRC, but also support GPS and Controller Area Network (CAN) bus are also in market [1–3]. Automobile and transportation companies have also been actively integrating DSRC into vehicles and developing various DSRC-enabled applications.

Thanks to its low latency advantage, DSRC enables various applications that, among many other benefits, can enhance safety by augmenting drivers' operating process. Many of such applications have been designed or prototyped. An intersection collision warning system, for example, can emit warning messages through DSRC when a vehicle is going too fast towards an intersection with red traffic light, so that other vehicles and pedestrians can be notified to avoid collision. As another example, an emergency braking warning system enables the vehicle to “see” another vehicle in front braking hard when the line-of-sight is blocked by a large vehicle, so that the vehicle can promptly

decelerate before the driver realizes the situation.

Among these safety applications, truck platooning provides many incentives to commercial companies. In addition to safety enhancement, truck platooning also benefits from fuel efficiency, resulting in lower operating cost. To obtain better understanding on how well DSRC can support platooning applications, this paper studies DSRC performance in the context of truck operations, primarily focusing on delivery ratio under various circumstances and with different parameters. Tests taken in this study include a set of dynamic tests run on a 2.74 km test track as a general case, and a few sets of static tests as case studies for particular scenarios, such as when the road is not horizontal or when the front truck is turning.

The paper is structured as follows: Section 2 provides a background of DSRC technology as well as truck platooning application, and discusses related work. Section 3 explains the motivation of this study. Section 4 describes the experimental setup, including hardware and software used in tests. Section 5 presents test results and discusses the possible reasons behind different phenomena. Section 6 concludes the study by summarizing the findings in this paper.

Peer review under responsibility of Chongqing University of Posts and Telecommunication.

\* Corresponding author at: Auburn University, Auburn, AL 36849, U.S.

E-mail addresses: [song@gao.io](mailto:song@gao.io) (S. Gao), [lim@eng.auburn.edu](mailto:lim@eng.auburn.edu) (A. Lim), [dmbevly@eng.auburn.edu](mailto:dmbevly@eng.auburn.edu) (D. Bevly).

<http://dx.doi.org/10.1016/j.dcan.2016.10.003>

Received 1 April 2016; Received in revised form 20 September 2016; Accepted 19 October 2016

Available online 03 November 2016

2352-8648/ © 2016 Chongqing University of Posts and Telecommunications. Production and hosting by Elsevier B.V. This is an open access article under the CC BY-NC-ND license (<http://creativecommons.org/licenses/by-nc-nd/4.0/>).

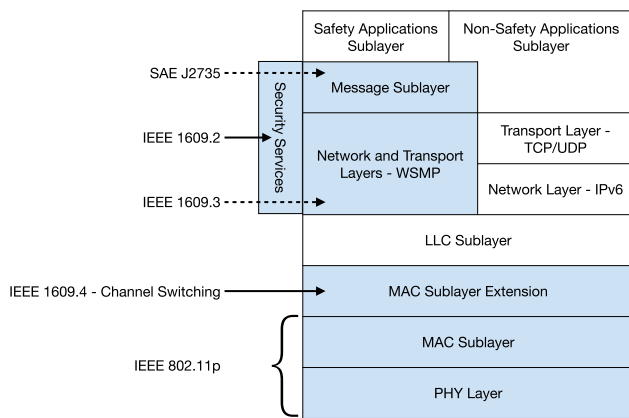

Fig. 1. DSRC protocol suite.

## 2. Background and related work

### 2.1. Dedicated short range communication

Dedicated Short Range Communication (DSRC), often used in Wireless Access in Vehicular Environment (WAVE), is a protocol suite designed for low latency networking in vehicular environments. The protocol suite [4], as illustrated in Fig. 1, is similar to TCP/IP over WiFi. In fact, it supports the IPv6 stack in parallel with a network and transport layer protocol called Wave Short Message Protocol (WSMP) that is dedicated to the DSRC suite. The WSMP branch of the protocol suite enables faster set-up and more space-efficient transmissions. Experimental tests in this paper focus on the WSMP branch of the protocol suite.

#### 2.1.1. IEEE 802.11p

IEEE 802.11p is derived from IEEE 802.11a, an early 5 GHz protocol used in WiFi. FCC has allocated the spectrum from 5.850 to 5.925 GHz, i.e., the “5.9 GHz band”, for DSRC operation in United States. This spectrum is divided into seven 10 MHz channels (channel 172, 174, 176, 178, 180, 182, 184) with 5 MHz guard band at the low end [4]. Channel <174, 176> and <180, 182> can be combined into 20 MHz channels. This spectrum is higher than the unlicensed 5.8 GHz spectrum used in the WiFi protocols, so DSRC applications do not suffer from interference generated by WiFi devices. As in the IEEE 802.11a protocol, the IEEE 802.11p uses Orthogonal Frequency Division Multiplexing (OFDM) for modulation and Carrier Sense Multiple Access/Collision Avoidance (CSMA/CA) for medium access control.

Unlike other IEEE 802.11 protocols where stations have to join a Basic Service Set (BSS) before they can transmit or receive data, IEEE 802.11p defines an Outside Context of BSS (OCB) mode, which is used in the WSMP branch of the protocol suite. In OCB mode, BSSID field of the frame header is set to a wildcard value FF:FF:FF:FF:FF:FF. It allows stations to transmit and receive data without registering with an infrastructure device or an existing ad-hoc network. As a result, the time required to activate a wireless device is significantly reduced.

In addition, the MAC sub-layer has an extension that supports channel switching, defined in IEEE 1609.4 [5]. One of the seven 10 MHz channels is dedicated as the control channel (CCH) while others work as service channels (SCHs). Channel switching allows concurrent access of CCH and SCHs. This is achieved by dividing each 100 ms into a 46 ms CCH interval and a 46 ms SCH interval, each followed by a 4 ms guard interval.

#### 2.1.2. WSMP

WSMP, defined in IEEE 1609.3 [6], is the networking service in DSRC and serves the purposes of the network layer and transport layer

Table 1  
WSM header.

Header field	Length
Version	1 byte
PSID	1–4 bytes
Extension	variable
Element ID	1 byte
Length	2 bytes
Payload	variable

from the TCP/IP stack. WSMP defines a message type that is efficient for 1-hop transmission. The message type is called Wave Short Message (WSM), whose minimum header size is 5 bytes, as shown in Table 1. Compared to UDP over IPv6, which is a similar configuration in the TCP/IP protocol stack that requires a minimum of 52 bytes of header, WSM’s overhead is much smaller and causes less congestion. Since channel congestion is a significant concern in DSRC, the efficiency of WSMP is quite valuable [4]. On the other hand, being such a minimum protocol, WSMP does not provide many powerful transport layer functionalities other than multiplexing, which is achieved through the Provider Service Identifier (PSID) field in the WSM header.

#### 2.1.3. Message sub-layer

On the top of WSMP layer is the Message Sub-layer, which provides direct support to applications. An important standard in this layer is the SAE J2735 DSRC Message Set [7]. J2735 defines many messages types that vehicular applications can utilize. The messages are encoded using ASN.1 format and always transmitted with WSMP. Each message is defined as a collection of constituent data structures, called data elements and data frames. A data element is the most basic data structure in the J2735 standard. A data frame is a more complex data structure, composed of one or more data elements or other data frames [4]. These data structures carry various information related to vehicular environment, from geometries of vehicle body to the dynamics of a running vehicle.

### 2.2. Truck platooning

Truck platooning is one of safety applications that DSRC enables. In truck platooning, Cooperative Adaptive Cruise Control (CACC) [8] plays an important role. CACC is based on Adaptive Cruise Control (ACC, also known as Autonomous/Active Cruise Control). In addition to maintaining speed like normal Cruise Control, ACC can adjust vehicle speed based on distance between the vehicle and other vehicles in front of it, i.e., headway distances. The distance detection relies on radar sensors mounted at the front of the vehicle. Due to the latency from the moment when a front vehicle brakes to the moment when the ACC enabled vehicle reacts to the decreased headway, safe following distance is still quite high in ACC systems.

CACC is different from ACC. Rather than completely relying on actual headway distance change and sensor accuracy, CACC incorporates V2V communication between vehicles. The vehicles can efficiently exchange safety related data such as vehicle’s status (speed, acceleration, etc.) and positioning data (GPS positions or GPS-free localization data [9]). As a result, headway distance can be further decreased without introducing extra safety issues. Fig. 2 is an example where front vehicle brakes. In this case, DSRC serves as a notification mechanism. As soon as the front vehicle’s driver hits the brake pedal, even before the front vehicle starts to decelerate, the braking signal is broadcast through DSRC, making the vehicle following closely aware of the situation and brake in advance. As shown in the figure, this shortcuts the front vehicle’s brake system, distance change, as well as back vehicle’s sensor system, reducing the reaction time significantly. With the reaction time reduces, the headway distance can be further

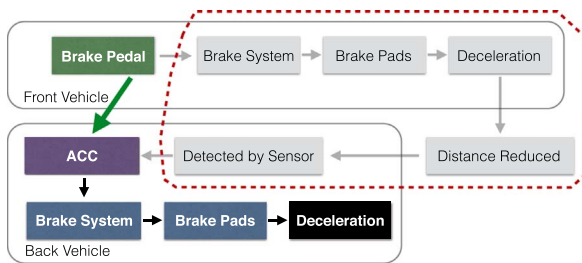

Fig. 2. CACC shortcuts control flow of ACC thus reduces reaction time.



Fig. 3. Left side of a truck with one of the DSRC antennas and GPS antenna shown. The other DSRC antenna is mounted on the right side.

Table 2 Options supported in the test software.

Name	Type	Description
<b>General Options</b>		
-tx	Boolean	Start in TX mode
-rx	Boolean	Start in RX mode
-gps	String	File-path for GPS logging
-log-file	string	File-path for message logging
-antenna	Integer	Antenna operating mode (Left, right, or alternate)
<b>TX Options</b>		
-duplicate <sup>a</sup>	boolean	Send each message twice
-msg-rate	int	# of WSMs to transmit /s
-msg-size <sup>b</sup>	int	Length (bytes) of each WSM
-data-rate <sup>c</sup>	int	MAC data rate (Mbps)

<sup>a</sup> This is practical in alternate antenna operating mode. Since the DSRC radio utilizes the left and right antenna alternately, sending each message twice implies that each message goes through both antennas.

<sup>b</sup> This is the size of payload inside WSMs, excluding headers from the WSM and MAC layers.

<sup>c</sup> The difference between -msg-rate and -data-rate is that, -msg-rate indicates how frequently WSM messages are demanded to transmit by applications (in this case, the test software), while -data-rate is the MAC layer data rate setting that corresponds to the rate at which binary data is encoded and modulated.

reduced on top of ACC, to the point where aerodynamic context can change significantly.

A close following distance might not be very appealing to consumer cars, but it brings huge benefits to commercial trucks. To be specific, short following distance can reduce air resistance (drag) for the vehicles [10], and the drag reduction results in fuel saving (up to 11% in some scenarios [11]). Since the largest operating expense of trucking is fuel, this is of great interest to transportation companies.

### 2.3. Related work

Bai and Krishnan [12] was the first study to characterize the

Table 3 Metrics collected in experiments.

Metric	Description
Latency	End-to-end delay from one truck to another
Delivery ratio	# of messages delivered over the total # of messages transmitted
Pairwise delivery ratio	# of pairs of consecutive messages delivered over the total # of pairs of messages transmitted
Message losses	Individual events of failure to transmit messages

Table 4 Parameters altered across the experiments.

Parameter	Values
Data rate (Mbps)	3, 4.5, 6, 12, 18, 24, 27
Message size (bytes)	50 <sup>a</sup> , 256 <sup>b</sup> , 1399 <sup>c</sup>
Message rate (Hz)	1, 10, 20, 100
Antenna	Left, right, alternate

<sup>a</sup> 50 bytes is close to the size of a minimum BSM message that only contains required fields.

<sup>b</sup> 256 bytes is close to the size of a typical BSM message that contains excessive vendor specific fields used for platooning purpose.

<sup>c</sup> 1399 bytes is the maximum allowed message size on the DSRC radio being used.



Fig. 4. NCAT satellite image.



Fig. 5. Static test setup in Location A where a hump is between the trucks.



Fig. 6. Static test setup in Location B where the front truck is turning.

application-level reliability of DSRC communication for vehicular safety communication applications based on real-world experimental data. The authors measured packet delivery ratio with varying distance in open field and freeway environment, and analyzed consecutive packet loss.

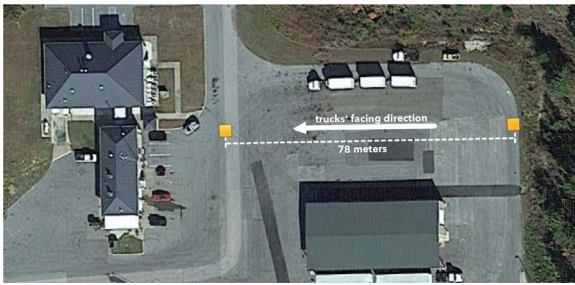

Fig. 7. Static baseline test setup in Location C, an open area.

Table 5

Abbreviations used in figures.

Shorthand	Fullname
MR	Message rate
DR	Data rate
MS	Message size

In [13], the authors analyzed and compared ad-hoc performance of commercial off-the-shelf DSRC devices and Wi-Fi radios in real vehicular environments, under different weather conditions. The paper concludes that: (1) performance of UDP traffic is significantly affected by the size and rate of transmitting data; (2) signal attenuation (i.e., performance degradation) often occurs in rainy weather; and (3) ad-hoc performance within desired communication coverage is quite stable, whereas the performance shows a significant drop in throughput and substantial increase in data loss at longer ranges or varying distances.

In [14], the authors investigated DSRC performance by measuring changes in application to application level delay, jitter and packet loss that is experienced through real-world experimentation. It was found that line of sight and the environment around OBU have a major impact on communication. The authors also inferred that the average delay experienced by WSMP packets was low and did not change drastically despite variation in the channel load on the same channel.

Our study is different from other related works in the way tests are designed and conducted. Since our primary goal is to understand DSRC performance in truck operation contexts, tests conducted in this study are designed to be closely related to typical truck operations. For examples, vehicles used in the tests are real-world semi-trailer trucks equipped with commercial DSRC radios. Also, the tests evaluate DSRC performance under different real-world scenarios, such as vehicle turning. These tests produce findings that help researchers and engineers better understand DSRC behavior under different truck operation contexts and design applications that are more robust in different road conditions.

### 3. Motivation

DSRC enables many applications in vehicular environments, including safety related applications, such as Emergency Braking Warning, Intersection Collision Warning, or Cooperative Adaptive Cruise Control. These safety applications are real time systems that rely on DSRC communication to perceive nearby vehicular environments, hence require extra guarantee on reliability of the communication. Therefore, it is important to study reliability and performance of DSRC in the context of safety applications.

Performance tests in this paper are particularly focused on the context of truck platooning, where two (or more) trucks are driven very close to each other on freeways. In the context of truck platooning, DSRC performance and reliability are concerned with several aspects that motivate the studies presented in this paper.

- 1. Lost messages are critical:** The brake signal in the above-mentioned notification mechanism, as well as other information such as speed and acceleration, are part of the Basic Safety Message (BSM), a type of beacon messages defined in SAE J2735 [7]. BSMs are encapsulated in WSMs and broadcast periodically by DSRC enabled vehicles. In platooning, continuous reception of BSMs provides the back vehicle awareness of the dynamics of the front vehicle. However, when messages fail to transmit, especially consecutive lost messages, the back vehicle does not have adequate information to infer whether it is safe to maintain the current speed. Hence, the safest decision that the system can make is to assume the worst (front vehicle decelerating) and brakes. In other words, to ensure safety, vehicle in platoon may experience unnecessary hard braking in the case of (especially consecutive) lost BSMs.
- 2. Latency matters:** BSM, among many DSRC messages, is a time-sensitive message. In platooning applications, vehicles rely on BSMs for information on nearby vehicles, in order to make safety related decisions. The more timely the BSMs are delivered, the smoother the vehicle can handle different situations. If the BSMs are delivered with high latency, the information that the vehicle can interpret only matches an overly aged situation, hence when the vehicle takes actions, it needs to intensify (e.g. more brake pressure) in order to counter the delay. In an extreme example, when the BSM latency is higher than the latency introduced by the vehicles' mechanics and radar sensors, advantage from using DSRC technology ceases to exist.
- 3. Vehicle body affects DSRC performance:** A semi-trailer truck is composed with a tractor and a trailer. Both the tractor and trailer have much larger height compared to consumer vehicles. If the DSRC antenna is mounted on the top, the truck body can block the line-of-sight between the truck's antenna and smaller vehicles next to it. To solve this problem, many researchers and engineers choose to mount two DSRC antennas on both sides of the tractor. However, side-mounted antennas have problems as well. In a typical design, the trailer is coupled with the tractor through a component called "fifth wheel". When the truck makes a turn, the tractor turns first, in a form similar to consumer cars. The turning of the tractor hauls the trailer through the fifth wheel, causing the trailer to follow the turn. In this process, the tractor and the trailer may not align with each other, causing one of the antennas to be blocked by the trailer from communicating with the vehicle right behind the truck. When the line-of-sight is blocked, wireless signals have to rely on reflection, in which case delivery ratio would be greatly reduced, especially when the transmission data rate is high.

By studying these issues through real-world experiments, we can better understand how DSRC performs in real world environments. It unveils or clarifies issues that need to be solved to make truck platooning feasible and efficient, and yields new research topics that can lead to real-world engineering improvements.

### 4. Experimental setup

Our main objective is to study the real-world performance of DSRC communication. To achieve the desired authenticity of results, the following approaches are taken:

1. A commercial implementation of the DSRC stack is used;
2. DSRC devices are mounted on real commercial semi-trailer trucks;
3. Test programs are written to emulate real-world scenarios;
4. Tests are conducted with trucks in different positions to reflect different real-world scenarios.

This section describes the experimental setup used in the tests.

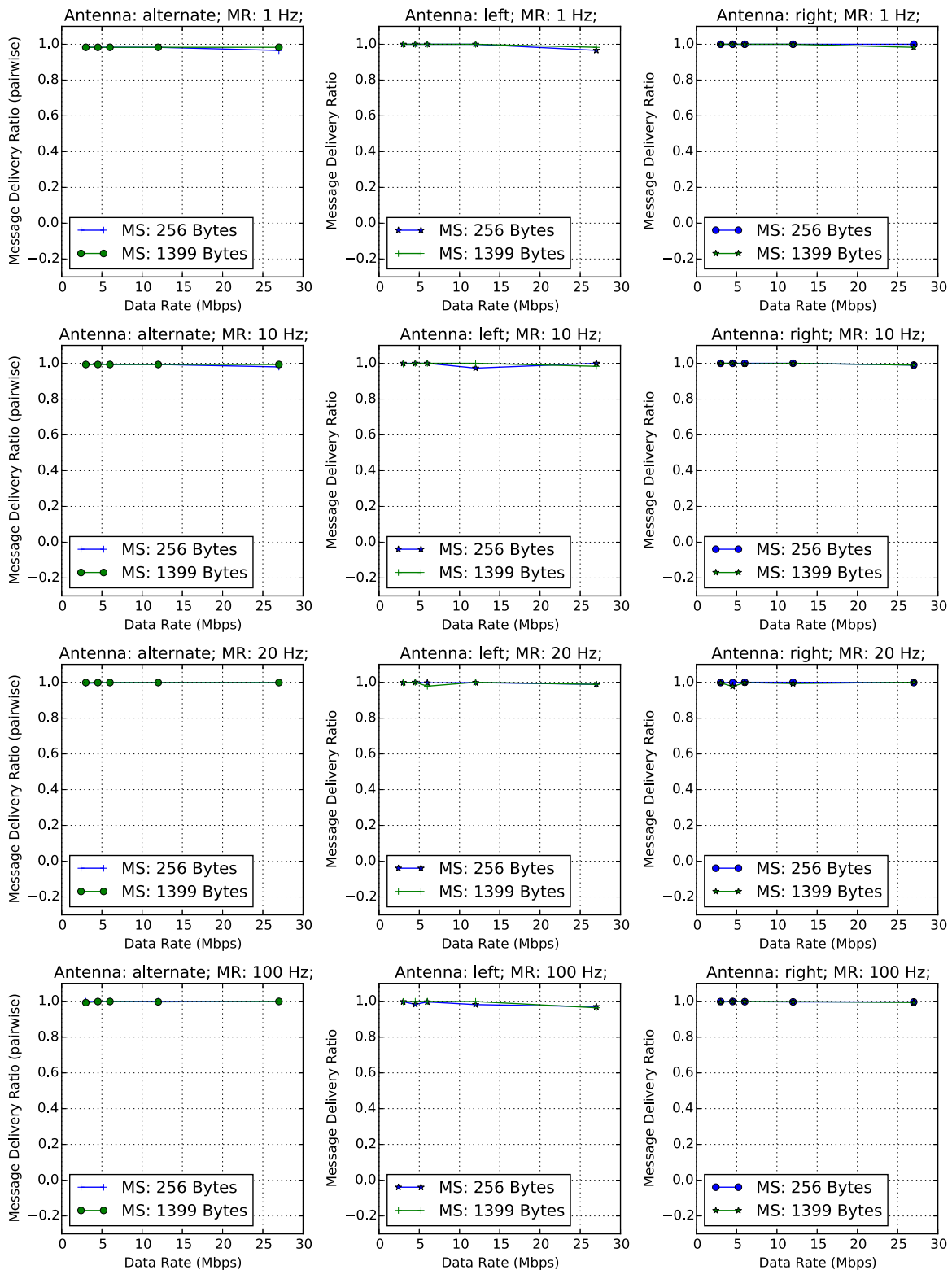
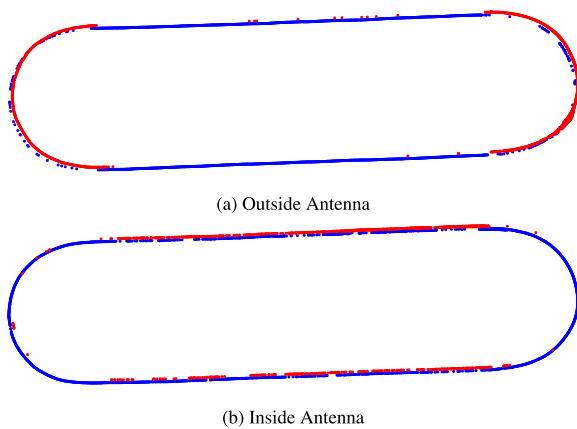

Fig. 8. Delivery ratio from baseline tests in location C.

#### 4.1. Test hardware setup

The DSRC protocol stack is a complex protocol suite that is difficult to emulate with existing protocols and devices, although most of it is derived from existing technologies. To ensure that the results reflect real DSRC performance, two commercial DSRC radios are used. The DSRC radio is an on board unit (OBU) that is commercially available

(the details of the hardware are proprietary), with full implementation of the DSRC stack. It uses two DSRC antennas to transmit and receive DSRC traffic. Applications can choose one of the antennas, or let the driver alternate between the two antennas automatically. The device supports two interfaces for applications to access the DSRC service: off-board access and on-board access. In off-board access, applications run on a separate device, and access the DSRC service through an Ethernet



**Fig. 9.** Individual message delivery plots from dynamic tests on the test track, with parameters: DR=3 Mbps, MS=1399 Bytes, MR=20 Hz. A blue point represents a successful transmission while a red point represents a loss. (a) Outside Antenna (b) Inside Antenna.



**Fig. 10.** Test track partition: white straight lines are where messages are marked as “Straight”, and red curves are where messages are marked as “Curve”.

port. This is useful for applications that require extensive processing power and need a separate hardware unit. In on-board access, applications are built based on the radio's architecture and runs on the DSRC radio device directly. This is useful for applications that are light enough to run on the embedded system that may be sensitive to latency.

To study how DSRC performance can be affected by the truck body, two commercial semi-trailer trucks are used in the tests. Truck tractors are of model Peterbilt 579, and the trailers attached to the tractors are standard 53 ft (16.15 m in length) models. On each truck, a pair of DSRC antennas are mounted on each side of the tractor, located near the back panel of the tractor. For this paper, only the upper ones on each side are used. Since IEEE 1609.4 needs time synchronization, time is acquired from GPS satellites through a GPS antenna that is mounted on left side of the truck and is connected to the DSRC radio. Fig. 3 shows the left side of a truck with the GPS antenna and one of the DSRC antennas.

#### 4.2. Test software

A test software is developed to test the DSRC performance. It accepts a few command-line options. The ones that are relevant in this paper are illustrated in Table 2. The test software works in either TX (transmit) or RX (receive) mode. In TX mode, the software periodically broadcasts messages through the WSMP stack according to the specified parameters. It logs a time-stamp and sequence number for each message that is being sent out. In RX mode, the software listens on the channel and PSID as configured, and logs a time-stamp and the sequence number whenever it receives a message.

There is a daemon running on the DSRC device that updates the system clock using the GPS time. This way, system clocks on the two DSRC devices running on both trucks are synchronized with only nanoseconds' error. Since the system clocks are in sync, timestamps logged by the testing software are synchronized as well. By comparing

the timestamps from both trucks, latency can be measured for each uniquely numbered message. By comparing the sets of messages transmitted and received, delivery ratio can be calculated as well.

To study how the surrounding environments affect DSRC performance, it is important to have the trucks' position information recorded with each event, e.g., packet losses. To help with this, the test software also keeps a GPS log file that has GPS coordinates logged with timestamps.

As in BSMs, the test software sends messages using a broadcast address. This implies that no MAC layer acknowledgements are involved and messages are not subjected to MAC layer retransmissions.

#### 4.3. Experiment design

As described in Section 3, the experiments in this paper are designed to study the performance and reliability of DSRC in the truck platooning context. Specifically, the test software is designed to collect different metrics, as illustrated in Table 3, while varying the parameters illustrated in Table 4. Channel 174, a 10 MHz channel at 5.9 GHz band, is used in all tests.

To better understand the dual-antenna configuration used on trucks, pairwise delivery ratio is introduced in this paper. It is similar to the normal delivery ratio, except that it represents the ratio of the messages delivered from either of a pair of antennas to the total pairs of messages sent. In pairwise delivery ratio, delivery of any one of a pair of duplicate messages indicates successful transmission of the pair. Since pairwise delivery ratio considers pairs of consecutive messages, it only makes sense when the antenna is set to alternate mode.

Tests are conducted at Auburn University's National Center of Asphalt Technology (NCAT) located at 3235°53.9'N, 8517°53.8'W. The area is spacious with very simple building structures and features a circular test track that is 2.74 kilometers long. Fig. 4 shows a satellite view of the area.

Two types of tests are used in this study: dynamic tests and static tests. Dynamic tests are conducted on the trucks running in the test track. This gives us insights into DSRC behaviors and individual events in different road situations. In the static tests, the trucks are parked at fixed locations. This provides more details on DSRC performance for more specific situations. To be more specific, the following tests are conducted.

- Dynamic Tests:** Both trucks run on the inside lane of the test track, operated by professional drivers. The truck speed is within the range from 70 km/s to 80 km/s, so that 135 s for each test instance would cover the entire 2.74 kilometers track. The distance between the two trucks is maintained according to drivers' ability and judgment, at around 20 m. Since the trucks are operated by humans, the actual following distance has to be longer than a typical CACC distance. As reported in [13], weather conditions can affect these results. Hence, we conducted the tests under similar weather conditions. All dynamic tests in this paper are taken on two lightly cloudy days in April, with very similar temperature and humidity.
- Static Tests:** The trucks are parked at some desired positions and remain stationary until all tests with different parameters are completed. Each test instance runs for 60 s. Positions used in static tests are labeled as A, B, and C in Fig. 4.
  - In Location A, as shown in Fig. 5, only tractors are used. The front truck (left) is on a downhill, while the back truck (right) is on an uphill. This configuration presents a situation where there is a small hump between the two trucks that can potentially block the signal or alter ground reflection. They are 78 m away from antenna to antenna.
  - In Location B, as shown in Fig. 6, trailers are attached to the tractors. The front truck is in a position as if it is turning left, while the back truck is straight. This configuration presents a situation where the trucks are entering a curve and one of the

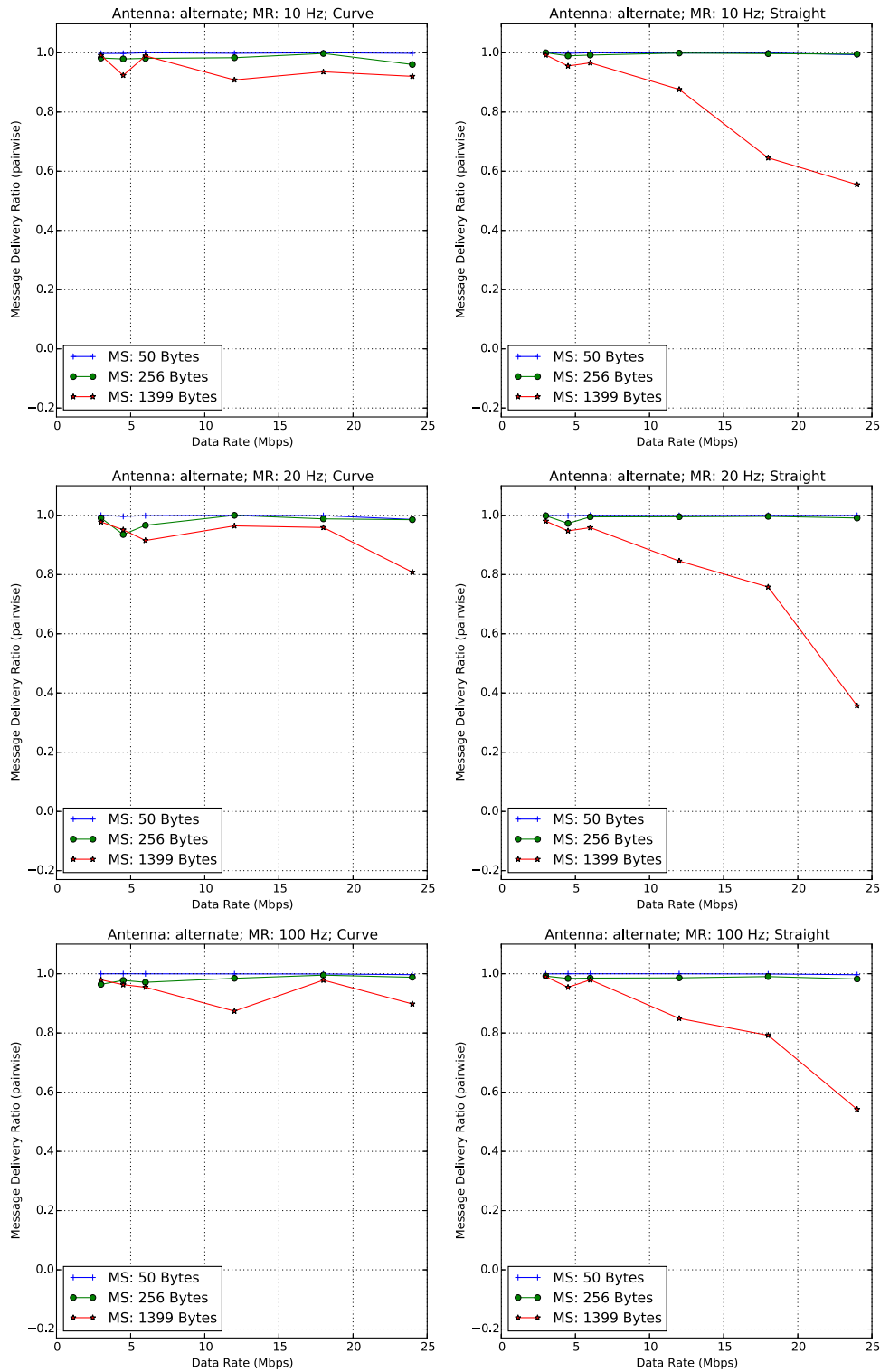

Fig. 11. Delivery ratio from dynamic tests on test track: alternate antennas.

two side antennas on the front truck may be blocked by its trailer. In this case, the trucks are 61 m away from antenna to antenna.

- (c) In Location C, as shown in Fig. 7, trailers are detached. The trucks are placed 78 m away antenna to antenna, in an open area. No significant structural factors are in this setting. It is used as a baseline configuration to compare with other locations.

## 5. Test results and discussions

For readability of plots, several abbreviations might be used in figures within this section, as shown in Table 5.

### 5.1. Delivery ratio and message losses

Several static tests and dynamic tests are conducted to measure the delivery ratio. To start with, a set of baseline results are presented.

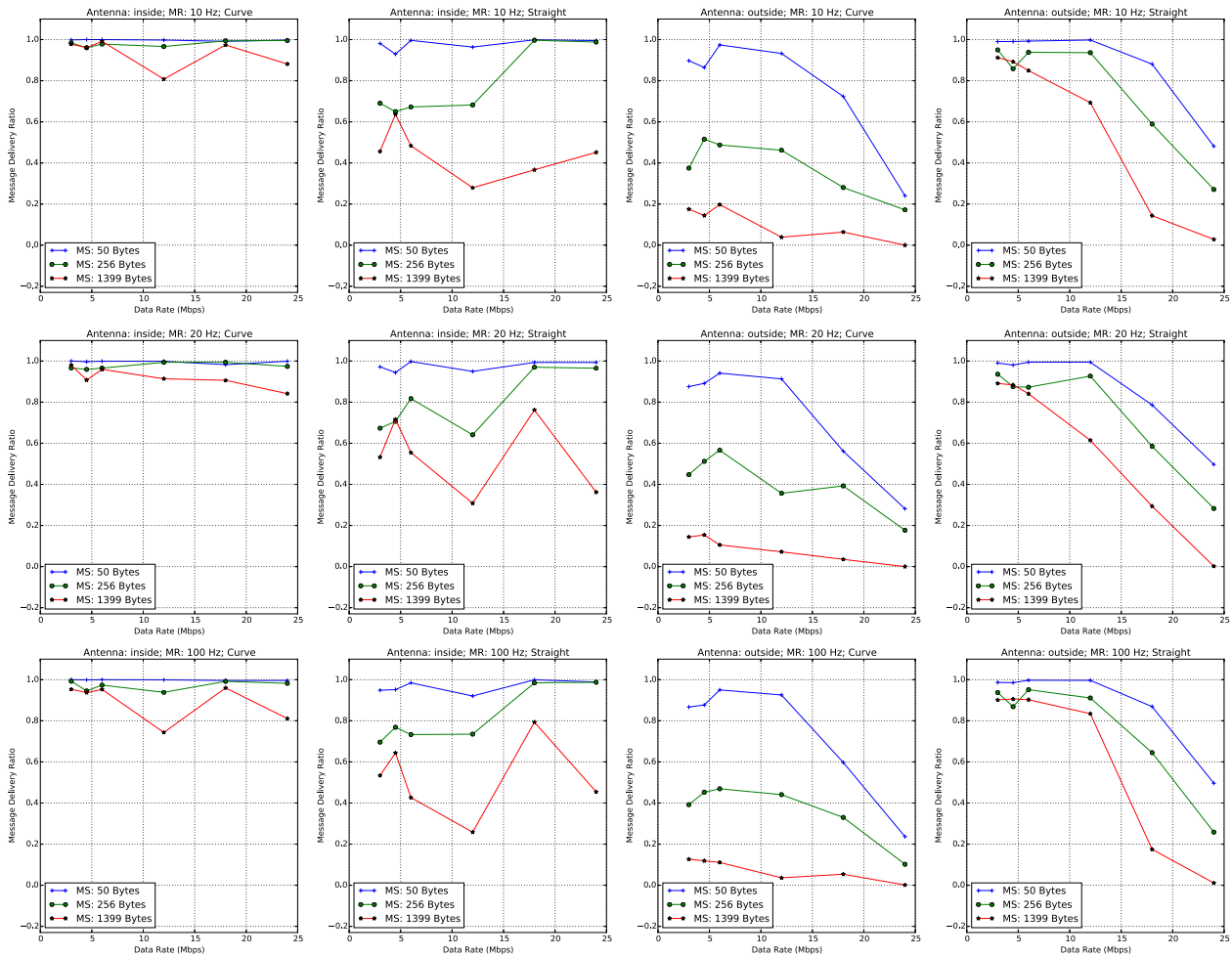

Fig. 12. Delivery ratio from dynamic tests on test track: side antennas.

Afterwards, dynamic tests and case studies with static tests are shown.

### 5.1.1. Baseline tests

The baseline tests are taken in Location C as described in Section 4.3. In these tests, as shown in Fig. 8, delivery ratio is close or equal to 100% in all parameter settings, except at some data rate when using one of the two antennas, the delivery ratio drops to about 96%. This is likely due to the reflection from subtle objects around the trucks.

The baseline tests demonstrate that the device is capable of achieving close-to 100% delivery ratio at long distance (78 m) without utilizing MAC layer retransmissions.

### 5.1.2. Dynamic tests

The dynamic tests, as described in Section 4.3, are taken on the test track. To start with, two individual results are shown in Fig. 9. Transmission of each message is visualized as a dot in the figure.

As expected, outside antenna performs poorly when going through the curves. In many portions of the curves, no messages are delivered at all. This is because the trailer of front truck blocks line-of-sight of the outside antenna. In addition, an interesting finding from the figure is that, on the straight parts of the track, inside antenna can suffer from serious packet losses while outside antenna is mostly fine. A possible explanation is that, the woodland that sits in the center of the track can produce reflections for signals from the inside antenna, and cause fading that results in corrupted data. The woodland outside the track, however, has little effect through reflections, because trucks run in inside lane and are further away from woodland outside the truck.

To find out how delivery ratio is related to different parameters in a

comprehensive way, aggregated figures are generated as well. In order to study how different portion of the track affect delivery ratio, messages logs are partitioned into “Straight” and “Curve” according to their logged GPS positions, as illustrated in Fig. 10.

Fig. 11 shows pairwise delivery ratios when the antennas are set to alternating mode. Since the pairwise delivery ratio takes two consecutive transmissions (one from inside antenna and the other from outside antenna) for each message, the advantages for antennas at curves or straight lines are eliminated. Instead, the delivery ratio is determined by the best performing antenna at the moment. As shown in the figure, apart from the obvious phenomenon that higher data rates result in lower delivery ratio, one can also see that delivery ratio is actually better at curves than straight lines by comparing the two columns in the figure. The authors believe this is because at curves, the signals of inside antenna is less affected by the front truck trailer or nearby terrain, compared to either antenna on the straight lines.

Taking a closer look at how each of the antennas performs, Fig. 12 shows delivery ratios when both trucks use side antennas. The general trends found in the figure is consistent with Fig. 9. Specifically:

- The inside antennas generally perform better at curved roads than on straight roads, especially with larger message sizes.
- The outside antennas perform better on straight roads than at curved roads with larger message sizes at lower data rates.
- The inside antennas perform better than the outside antennas at curved roads in all cases, as expected.
- The outside antennas perform better than the inside antennas on straight roads in a vast majority of the cases, where the difference is



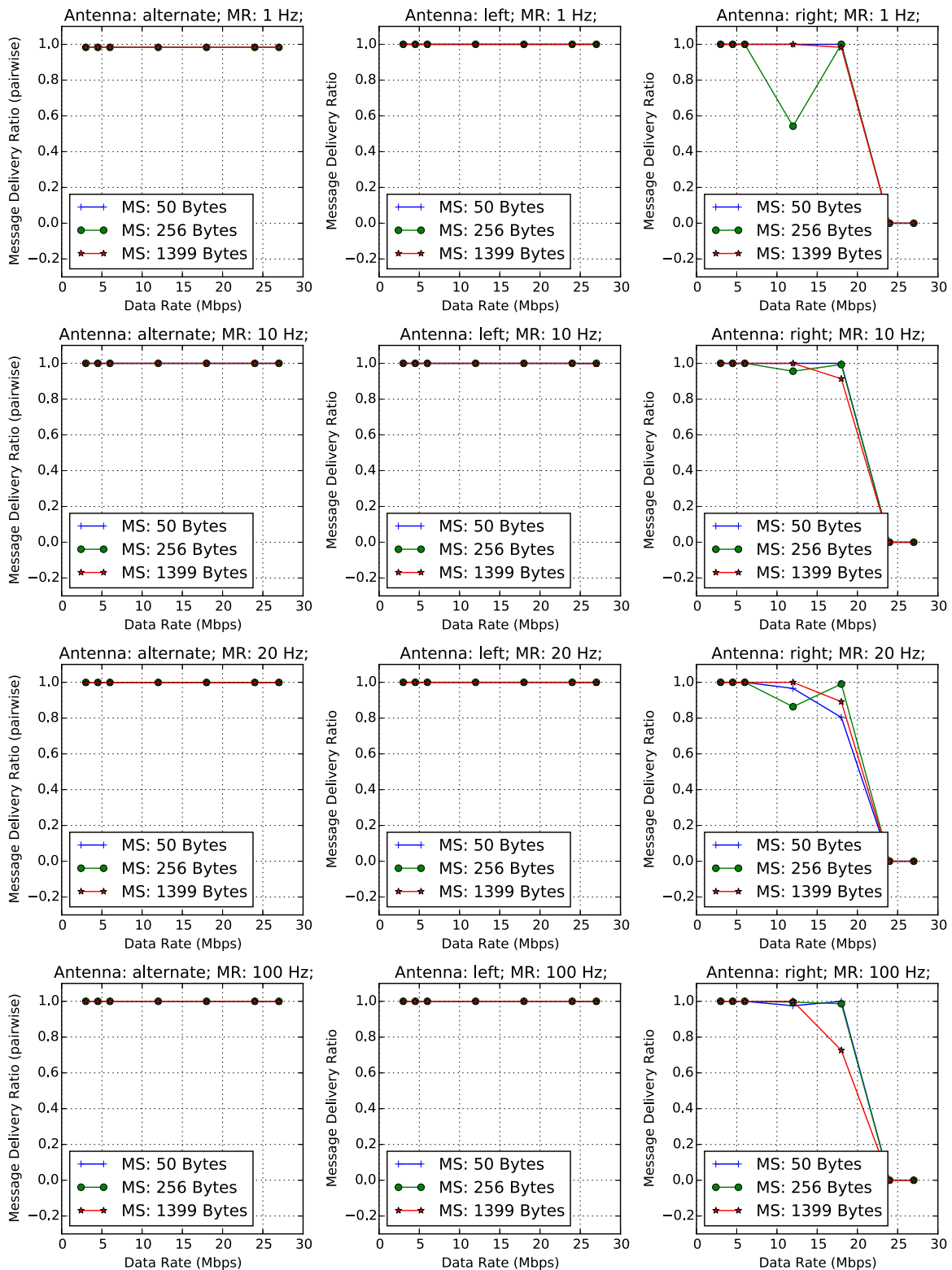

Fig. 13. Delivery ratio from tests in Location B, where the front truck is turning.

much larger at lower data rates.

5.1.3. Static test: front truck turning

As a case study, a set of static tests are run to further explore the scenario where the front truck is turning and the outside antennas are blocked by the trailer. These tests are taken in Location B as described in Section 4. Since the trucks are further away from any woods, this

eliminates an environmental factor that affects results from the test track. Fig. 13 shows the delivery ratio in this scenario. The left antenna, which is the inside antenna in this case, constantly achieves 100% delivery ratio. This causes the pairwise delivery ratio in alternate mode to be 100% as well. However, the right (outside) antenna's delivery ratio starts to degrade from 12Mbps data rate and beyond. There seems to be an outlier with 12Mbps data rate at 1 Hz message rate which is

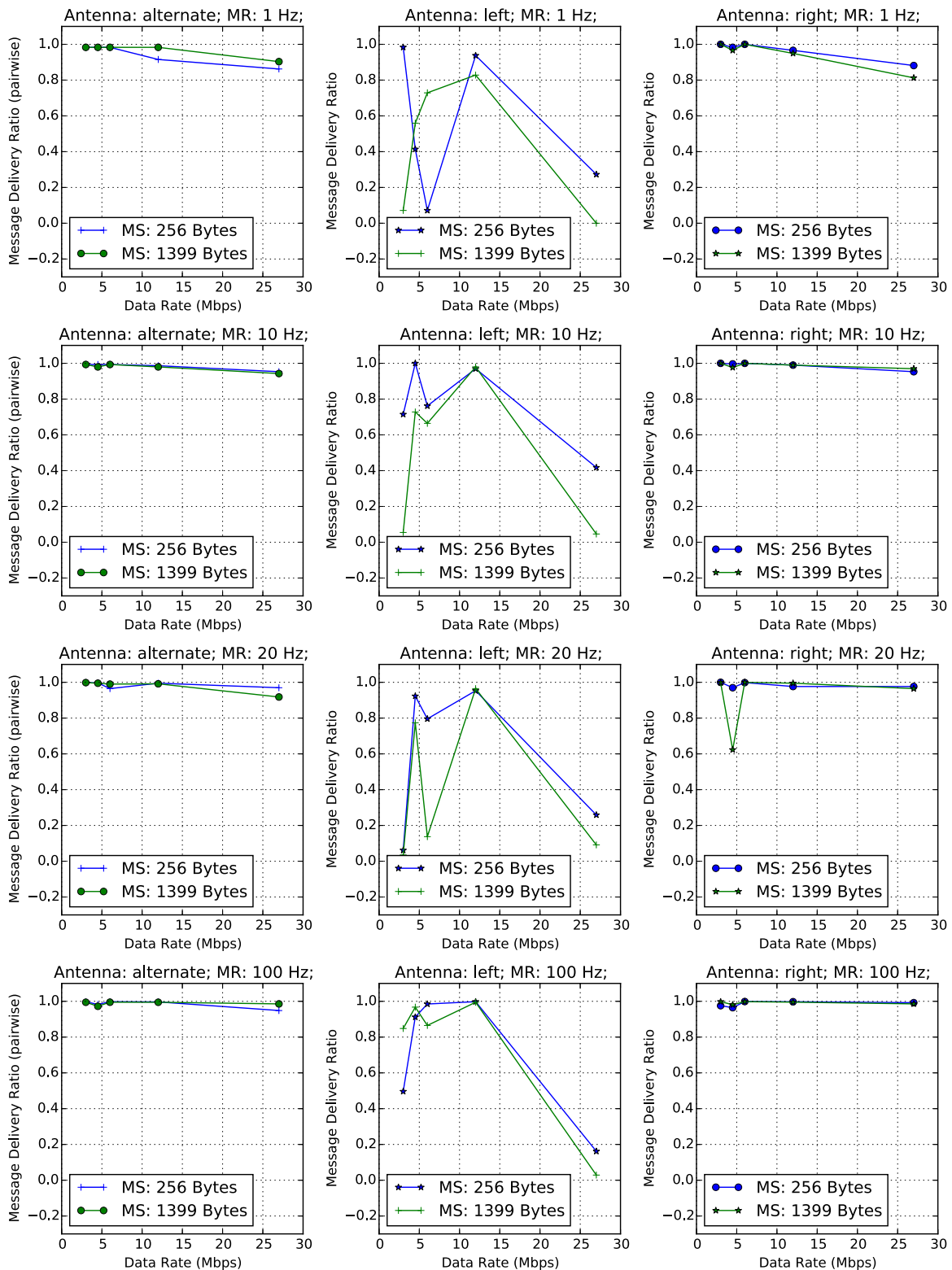

Fig. 14. Delivery ratio from tests in Location A, where a hump is in between the trucks.

probably due to the smaller sample size at low message rate.

#### 5.1.4. Static test: hump in between

As another case study, a set of static tests are run in Location A as described in Section 4. These tests emulate a scenario that is not present at the test track used in dynamic test but is quite possible in the real world. Results are shown in Fig. 14. Unlike the previous results,

the delivery ratio on both antennas are affected. This is because the antennas on front and back trucks are not parallel anymore, but are slightly “V” shaped due to the trucks being on both uphill and downhill. However, the right side antenna is less affected. A possible reason to this is the slight difference in terrain on each side. Despite the fact that one of the antennas is adversely affected, the pairwise delivery ratio in alternate mode is still above 90% all the time.

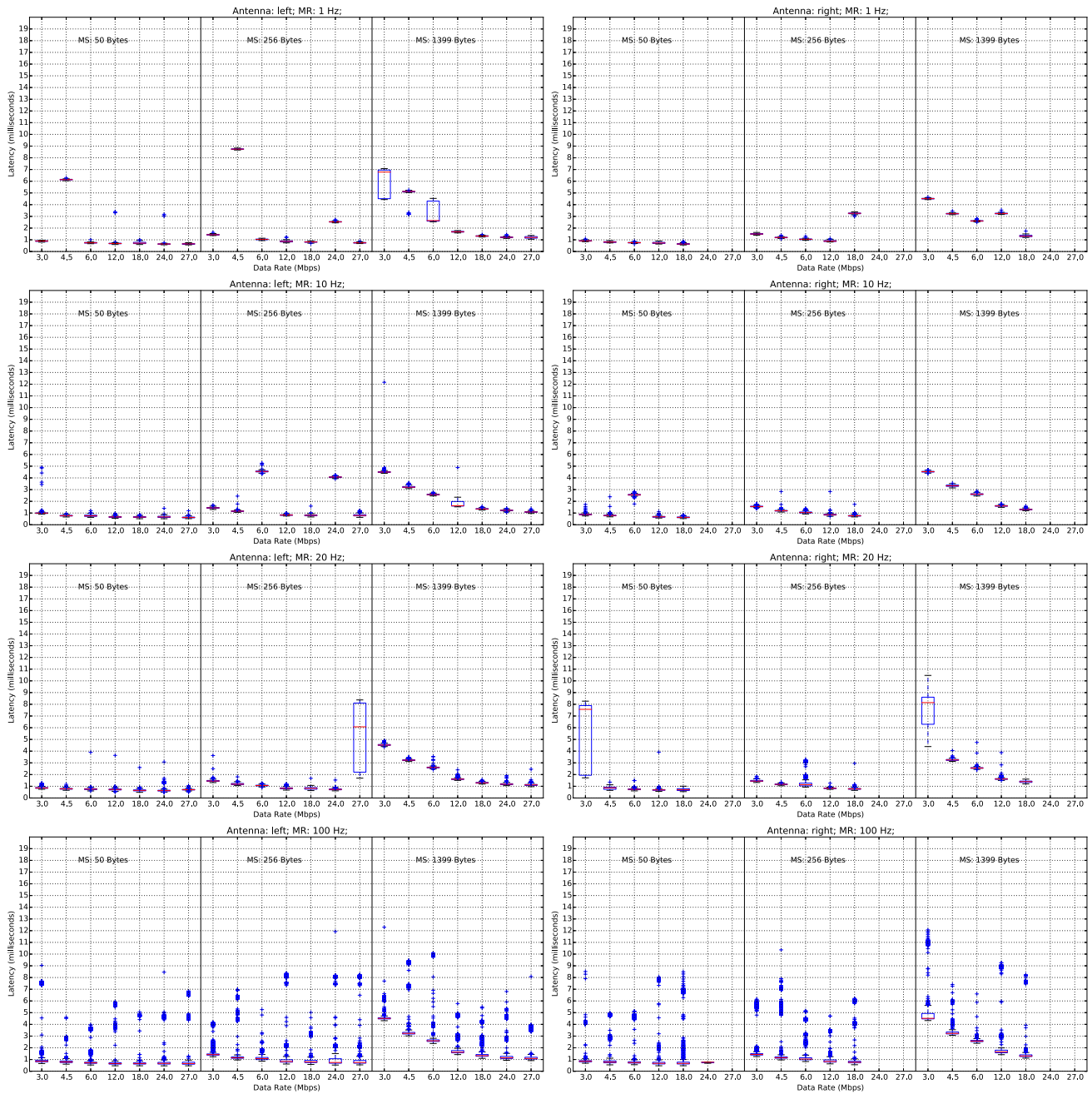

Fig. 15. Latency from tests in Location B.

### 5.2. Latency

Normally latency varies in different situations because of two reasons:

- In CSMA/CA, contention window is increased when the channel is congested. This causes the average time required to send a frame to increase, thus increases average latency.
- In unicast, when an ACK is missing, it is an indication that the frame is not delivered due to low signal-to-noise ratio or collision. In this case, the MAC layer retransmits the frame until an ACK is received or a pre-defined number of retransmissions is reached. This increases the overall latency for the message.

In this study, however, no other nearby device is using the 5.9 GHz band during the tests, so channel congestion due to other devices

should not happen. Broadcast is used all the time, so no retransmission happens either. As a result, latency measurements are mostly the same in different situations. This is also consistent with results from [14]. Hence, only one set of latency results are included in this paper.

Fig. 15 shows latency measurements from Location B in box plots. As shown in the figure, larger message size results in higher latency, and higher data rate results in lower latency. This is because larger message takes longer to modulate, and higher data rate means faster modulation. The jitters are high at 100 Hz message rate. The authors believe this is because of internal scheduling overhead of the DSRC radio being used. If we ignore the outliers, the latency is mostly under 5 ms.

### 6. Conclusion

This paper presents extensive experimental measurements of a

DSRC device in the context of truck operations. Our main findings can be summarized as follows:

- In an ideal environment, DSRC achieves nearly 100% delivery ratio at all data rates with any message sizes and rates, even at a distance as long as 78 m.
- When a truck is turning, the outside antenna may be blocked by its trailer, affecting delivery ratio, but the inside antenna normally works very well. This is more distinguishable at higher data rates.
- While on a straight line with complex terrain nearby, delivery ratio can still be low, especially with large message size and high data rates. The delivery ratio can even be lower than at curves.
- If the road is hilly, trucks can be misaligned (not parallel) with each other, resulting in lower delivery ratio. However, in some situations, complex terrains may generate reflections that can improve the delivery ratio and reduce the adverse effects of hilly roads.
- Using both side antennas alternately can normally improve delivery ratio significantly since it is determined by the best performing antenna at any moment.
- In broadcast contexts, such as BSMs, the major factors that affect latency are the lower layer components such as OS scheduler, driver, and hardware, rather than the environment.

### Acknowledgement

This research is supported in part by the U.S. Federal Highway Administration, under Contract No. DTFH61-13-H-00019, entitled *Heavy Truck Cooperative Adaptive Cruise Control: Evaluation, Testing, and Stakeholder Engagement for Near Term Deployment*.

### References

- [1] Arada Systems, Locomate products, URL, (<http://www.aradasystems.com/products/>).
- [2] DENSO INTERNATIONAL AMERICA, INC., Denso connected vehicle technology 1, 2012, URL, ([http://www.densomedia-na.com/press\\_kits/naias2012/technology/Jan\\_9\\_V2X\\_Brochure\\_final%20.pdf](http://www.densomedia-na.com/press_kits/naias2012/technology/Jan_9_V2X_Brochure_final%20.pdf)).
- [3] Unex Technology Corp., Unex: V2x and v2x fusion technology, URL, (<http://www.unex.com.tw/v2x>).
- [4] J. Kenney, Dedicated short-range communications (dsrc) standards in the united states, Proc. IEEE 99 (7) (2011) 1162–1182. <http://dx.doi.org/10.1109/JPROC.2011.2132790>.
- [5] Ieee standard for wireless access in vehicular environments (wave) – multi-channel operation, IEEE Std 1609.4-2010 (Revision of IEEE Std 1609.4-2006), 2011, pp. 1–89, (<http://dx.doi.org/10.1109/IEEESTD.2011.5712769>).
- [6] IEEE standard for wireless access in vehicular environments (wave) – networking services, IEEE Std 1609.3-2010 (Revision of IEEE Std 1609.3-2007), 2010, pp. 1–144, (<http://dx.doi.org/10.1109/IEEESTD.2010.5680697>).
- [7] SAE, J2735 Dedicated Short Range Communications (DSRC) Message Set Dictionary, Society of Automotive Engineers, DSRC Committee.
- [8] K.C. Dey, L. Yan, X. Wang, Y. Wang, H. Shen, M. Chowdhury, L. Yu, C. Qiu, V. Soundararaj, A review of communication, driver characteristics, and controls aspects of cooperative adaptive cruise control (cacc), IEEE Trans. Intell. Transp. Syst. 17 (2) (2016) 491–509. <http://dx.doi.org/10.1109/TITS.2015.2483063>.
- [9] X. Wang, L. Gao, S. Mao, S. Pandey, Csi-based fingerprinting for indoor localization: a deep learning approach, IEEE Trans. Veh. Technol. 99 (2016) 1. <http://dx.doi.org/10.1109/TVT.2016.2545523>.
- [10] A. Watts, Computational Characterization of Drag Reduction for Platooning Heavy Vehicles, Master's thesis, Auburn University, 2015.
- [11] M.P. Lammert, A. Duran, J. Diez, K. Burton, A. Nicholson, Effect of platooning on fuel consumption of class 8 vehicles over a range of speeds, following distances, and mass, SAE Int. J. Commer. Veh. 7 (2014) 626–639. <http://dx.doi.org/10.4271/2014-01-2438>.
- [12] F. Bai, H. Krishnan, Reliability analysis of dsrc wireless communication for vehicle safety applications, in: Intelligent Transportation Systems Conference, 2006, ITSC'06, IEEE, IEEE, 2006, pp. 355–362.
- [13] S. Lee, A. Lim, An empirical study on ad hoc performance of dsrc and wi-fi vehicular communications, Int. J. Distrib. Sens. Netw. (2013).
- [14] N. Vivek, S. Srikanth, P. Saurabh, T. Vamsi, K. Raju, On field performance analysis of ieee 802.11p and wave protocol stack for v2v amp; v2i communication, in: Information Communication and Embedded Systems (ICICES), 2014 International Conference on, 2014, pp. 1–6. (<http://dx.doi.org/10.1109/ICICES.2014.7033960>).

[1] Arada Systems, Locomate products, URL, (<http://www.aradasystems.com/>)