

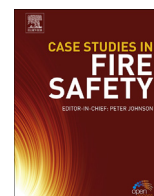

ELSEVIER

Contents lists available at [ScienceDirect](http://www.sciencedirect.com)

Case Studies in Fire Safety

journal homepage: www.elsevier.com/locate/csfs

Detection of fires in the toilet compartment and driver sleeping compartment of buses and coaches—Installation considerations based on full scale tests



Ola Willstrand*, Jonas Brandt, Robert Svensson

SP Technical Research Institute of Sweden, Fire Research, Box 857, SE-501 15 Borås, Sweden

ARTICLE INFO

Article history:

Received 3 August 2015

Received in revised form 13 November 2015

Accepted 18 November 2015

Available online 2 December 2015

Keywords:

Fire detection

Buses

Toilet compartments

Sleeping compartments

Full scale tests

ABSTRACT

Effective fire detection systems properly installed in bus and coach toilet compartments and driver sleeping compartments may save human lives and property loss. Rapid detection allows for early evacuation and extinguishment of a small fire, while late or no detection may allow the fire to spread. The purpose of the work presented in this paper is to provide recommendations on how to install fire detection systems in toilet compartments and driver sleeping compartments. The recommendations also cover what type of detection system is most suited. As a basis for the recommendations, full scale fire tests were performed with different detection systems. The fire tests were conducted in realistic mockups of a toilet compartment and a sleeping compartment. Different heat and smoke detection systems were analyzed at different positions for different fire scenarios to provide information on how to best install detection systems in these compartments. Five different scenarios were run and the most interesting finding was that two realistic fire scenarios in the toilet compartment did not activate fire detectors in the ceiling at realistic air flow rates. It is very rare that fire detectors are placed anywhere else than on the ceiling in toilet compartments on buses and the fire would then be very large upon detection.

© 2015 The Authors. Published by Elsevier Ltd. All rights reserved.

1. Introduction

Fires in buses and coaches are very common and on average several buses¹ worldwide are involved in a fire incident each day. For instance, in the US approximately 160 bus fires were reported each year between 2004 and 2008 [1]. In Australia there are about 70 bus fires per year resulting in insurance claims [2] and in Sweden, Norway, and Finland about one percent of all buses in service, will suffer from a fire incident each year [3,4].

If passengers have reduced mobility the evacuation time may be severely extended. For instance, 20 elderly people died in a bus fire in Hannover 2008 [5]. The fire was caused by a short circuit in an electrical cable near the toilet and spread via the toilet compartment to the passenger compartment. With an effective fire detection system this tragedy might have been prevented. However, not all fire incidents lead to fatalities, but the property loss and the cost due to rescue operation, traffic jam, and clean up can be extensive. The environmental effects of both the fire itself and extinguishing agents may also be

* Corresponding author. Tel.: +46 10 516 50 00, Direct: +46 10 516 54 50; fax: +46 33 13 55 02.

E-mail address: ola.willstrand@sp.se (O. Willstrand).

¹ In this paper the term “bus” refers to buses as well as coaches.

severe [6]. All these effects might be mitigated with an effective fire detection system that enables early evacuation and suppression of the fire.

Based on reported fire incidents in buses and coaches the fires most frequently originate in the engine compartment or in the wheel well [1,4]. Several studies of fire protection in the engine compartment have recently been performed [7–9], and ongoing fire detection projects for these spaces are running e.g., at SP Technical Research Institute of Sweden. However, this paper focus on fire detection in the toilet compartment and driver sleeping compartment and no extensive study on fire detection in these compartments has, to our knowledge, been reported. In media, recent bus fires have been reported where the fire started in the toilet compartment [10,11] and in the catastrophic bus fire in Hannover 2008 the fire also started in the interior of the bus [5]. The study reported in this paper was partly triggered by the new UNECE requirement, regarding fire detection in the toilet compartment and driver sleeping compartment of buses, that came into effect in July 2014 [12]. The new requirement states that an excess temperature or smoke shall be detected in these compartments.

Reported in this paper is an investigation of what types of detection systems are most suitable in the toilet compartment and driver sleeping compartment of buses and how to best install the systems in these types of compartments. The main questions answered by this paper are how different types of detection systems placed at different positions respond to different fires and how the ventilation conditions may influence the response time.

2. Method description

Fire detector systems were tested at different positions in realistic test mockups of the toilet compartment and the driver sleeping compartment of buses. Different fire sources were positioned at different locations inside the mockups and tests were performed under different ventilation conditions.

2.1. Mockups

Statistics on height, width, and depth for toilet compartments and driver sleeping compartments were collected for 26 different buses and mean values were used for the design of the mockups [13]. The mockups are shown in Figs. 1 and 2. The toilet compartments of buses have in general quite similar dimensions and the largest differences were found between toilet compartments positioned in the rear of the bus and toilet compartments in double-deckers compared with toilet compartments positioned in the staircase, which is the most common location. The dimensions of the driver sleeping compartments were found to vary more than for toilet compartments, but also for these the mean values of the survey were used. The depth was in most cases the width of the bus. The sleeping compartment mockup has decreased ceiling height in the middle section which is due to the gangway in the passenger compartment. This decrease is not existent in all buses and it could also vary in size, but it was included in the mockup because it delays smoke distribution which severely affects detectors not placed in the direct vicinity of the fire.

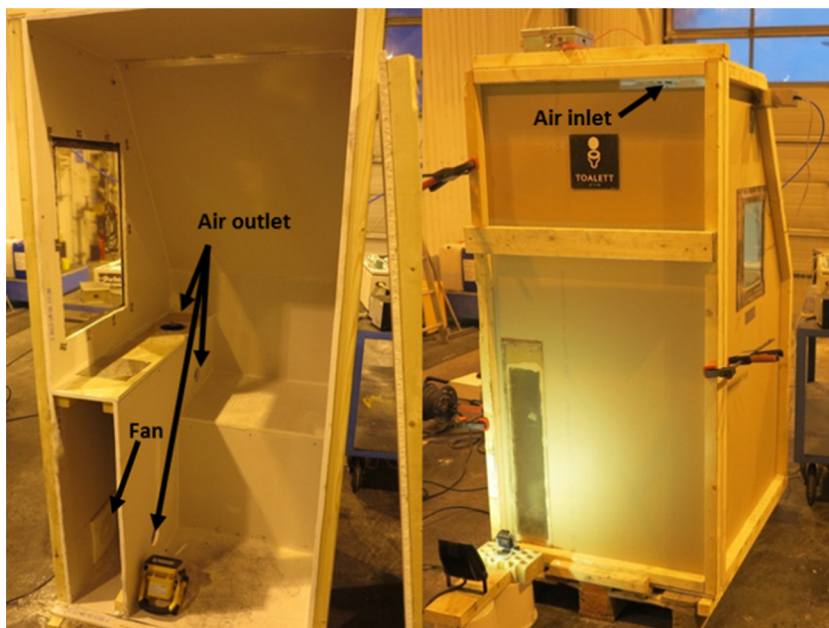

Fig. 1. Mockup of the toilet compartment in buses, seen from the front without door (left image) and with door (right image).

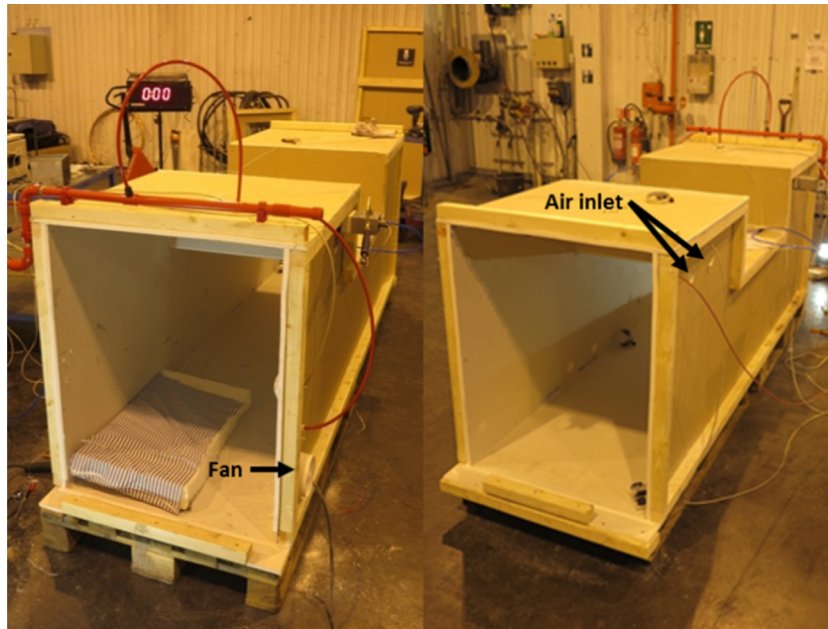

Fig. 2. Mockup of the driver sleeping compartment in buses, seen from two opposite sides.

The ventilation conditions in toilet compartments and sleeping compartments were examined by measurements in two different buses and by obtaining information from a WC system manufacturer. The bus manufacturers were not able to provide information about the air flow through the toilet compartment and sleeping compartment, but only the air flow entering the passenger and driver compartment. There are differences between different buses, but there are also similarities. In toilet compartments air is sucked out via a separate fan and exits under the bus, which applies to all bus toilet compartments since this configuration prevents odors from reaching other areas of the bus. The air enters via gaps around the door in most toilet compartments. However, some compartments, especially rear toilet compartments, do have a feed from the air conditioning system. In the mockup the air inlet was located in the upper right corner of the toilet compartment door, similar to some buses which have a larger gap at the door hinge. The air outlet occurred through three different holes leading to an enclosure containing the fan. Two of the holes were air vents (most buses have one or two of these) and one hole was the opening for the trash can. Not all buses have this configuration of the trash can, there might be other locations and sometimes a top on the trash can, but this was thought as the most interesting case since fire smoke from the trash can might be prevented by the airflow from reaching the toilet compartment, with important implications for detection.

In the driver sleeping compartment the ventilation conditions differ more between buses, but generally there is a manually operated fan and some passive inlet/outlet channels. In the mockup a fan was placed in one end of the compartment sucking out air and in the other end there were two air inlet vents. This was thought as the worst case condition since the air flow may delay the smoke spread to the air inlet section of the compartment, increasing the response time of a detector placed in that section. Fan positions and air inlets/outlets are marked in Figs. 1 and 2.

2.2. Test scenarios

During the tests different ventilation conditions were used with approximate air flows in accordance with Table 1. In the toilet compartment the high fan speed configuration is the most common condition, but the air flow depends much on how sealed the toilet compartment is since the fan normally has a free blowing capacity of 160–220 m³/h. For an untight toilet compartment the air flow could then be much higher. Some toilet compartments have two fan modes, when the toilet compartment is unoccupied it runs at a lower speed than if the compartment is occupied. The low fan speed configuration in the tests is primarily a realistic air flow for these toilet compartments.

For the driver sleeping compartment the tests were performed with a high fan speed mode and with the fan turned off.

Table 1

Different fan configurations used in the tests.

	High fan speed	Low fan speed
Air flow through toilet compartment	60–90 m ³ /h	20–30 m ³ /h
Air flow through sleeping compartment	80–90 m ³ /h	

Table 2
Test scenarios.

Test	Fire source	Fire position	Ventilation condition
1	Cigarette	Toilet compartment, seat level	Low fan speed
2	Paper	Toilet compartment, trash can	Low fan speed
3	Paper	Toilet compartment, trash can	High fan speed
4	Heptane pool	Toilet compartment, floor level	Low fan speed
5	Heptane pool	Toilet compartment, floor level	High fan speed
6	Plastics/rubber	Toilet compartment, above fan	Low fan speed
7	Plastics/rubber	Toilet compartment, above fan	High fan speed
8	Mattress	Sleeping compartment, fan section	High fan speed
9	Mattress	Sleeping compartment, fan section	No fan

The tests performed are presented in Table 2. Each test was run twice with very small differences in detection times and fire development. Temperatures, obscuration measurements, and detection times presented are averages.

In the cigarette test a standard cigarette from NIST (National Institute of Standards and Technology) was smoked and consumed in about one minute. In the paper tests a trash can full of paper hand towels was ignited by a hot wire. The size of the heptane pool was $10 \times 10 \text{ cm}^2$ and it was positioned on the floor in the large toilet compartment space. The heptane pool is not a realistic fire source in the toilet compartment, but was used because of good repeatability compared to the other fire sources. The plastics and rubber fire source was positioned under the sink, in the concealed space where the fan was located, symbolizing a pump, cables, and other electronic devices contained here. It was ignited by a hot wire as for the paper tests. The mattress, polyether foam with cotton cover, in the sleeping compartment was ignited by a hot wire through the corner of the mattress. No test was run longer than four minutes and in some cases only for about two minutes. The fires peaked or stabilized in this time and the tests were cancelled when no more fire alarms would have changed the results or conclusions. Temperatures and smoke obscuration curves for all fires can be found in the test report [13].

2.3. Detectors

The different types of detectors used in the tests are shown in Table 3. All smoke detectors are based on the photoelectric principle. The reason why no ionization smoke detectors were tested is due to the fact that the photoelectric detectors are more common among the vehicle fire alarm and suppression system suppliers. One reason for that is incurred regulatory cost for manufacturing, transport, and disposal of ionization smoke detectors [14]. In addition, the aim of the testing was not to compare the response time of different photoelectric or ionization smoke detectors, but rather to compare different detector placements and to compare point smoke detectors to aspirating systems and heat detectors. The smoke/heat detectors have one smoke sensor and one heat sensor that activated separately in these tests. All detectors are commercial approved detectors and differences in sensitivity reflect market. The activation levels of the aspirating systems are stated for the measuring chamber and if the detector samples air from more than one place the smoke will be diluted before it reaches the measuring chamber. Smoke obscuration measured in decibel per meter (dB/m) is the reduction of light passing through the smoke.

The tested aspirating smoke/heat detectors use standard point smoke/heat detectors together with a sampling system, which makes it less expensive than traditional aspirating smoke detector systems that are sensitive enough to use many sampling holes. In the tests each of this type of detector sampled air from one position, whereas the more sensitive aspirating smoke detector sampled air from two positions. Note in the results how number of sampling holes and sensitivity affects the detection times of smoke detectors.

In the tests the detectors, thermocouples (TC), and obscuration meters had different positions and these positions are listed and explained in Tables 4 and 5 and Fig. 3. Each number in Table 5 represents a separate detector, except for the aspirating smoke detector which uses two sampling points indicated by a plus sign. The obscuration meter in the toilet compartment ceiling covers both position 1 and 2.

Table 3
The four different detectors used in the tests.

	Activation
Point smoke detector	0.5–1.0 dB/m
Point smoke/heat detector	0.1–0.15 dB/m, 54 °C
Aspirating smoke/heat detector	0.1–0.15 dB/m, 54 °C
Aspirating smoke detector	0.02 dB/m

Table 4
Explanation of positions.

Toilet compartment	
1	Ceiling left (fan/trash can side)
2	Ceiling right (air inlet)
3	At the opening of the trash can
4	Under sink (in the concealed space containing the fan)
Sleeping compartment	
5	Ceiling fan section
6	Ceiling middle section
7	Ceiling air inlet section
8	Ceiling above fire origin
9	Wall above fan (half-height to the ceiling)

3. Results

In [Table 6](#) the response times of all detectors in the different tests are summarized while further comments concerning the tests are given in the following sections.

3.1. Cigarette test

The only detector initiating an alarm in this test was the aspirating smoke detector, which also is expected to be the most sensitive one according to [Table 3](#) (even though two sampling holes were used). The aspirating smoke/heat detectors (pos. 2 and 4) gave pre smoke alarms, which means that the smoke obscuration alarm level was reached but since the smoke concentration thereafter decreased no confirming fire alarms were initiated. According to the smoke detectors and the obscuration meters it was approximately the same amount of smoke at the ceiling as under the sink, but a higher fan speed would probably have reduced the smoke concentration in the ceiling, since the smoke would be drawn directly towards the fan. No cigarette test with high fan speed was performed however. That most of the detectors did not give a fire alarm on cigarette smoke is at least partly due to the fact that these detectors are designed to have a high resistance to false alarms. In this scenario that means that the obscuration due to the cigarette smoke was too low. A simpler detector may be more sensitive to cigarette smoke, but could also be more prone to false alarms due to e.g., dust.

3.2. Paper tests

All detectors in the concealed space under the sink were activated in the paper tests, but none of the detectors located at the ceiling activated. The smoke detectors activated already before there were visible flames. The main difference between the low fan speed and the high fan speed test was that with the low air flow some smoke entered the main toilet compartment space after a while, which was seen by the obscuration meter and the thermocouples at the ceiling, but for the high air flow no smoke or heat entered the main toilet compartment space. [Fig. 4](#) shows how the flames are held below the trash can opening by the air flow.

3.3. Heptane pool tests

In the heptane pool tests the difference between the low fan speed and high fan speed test was very significant. A comparison of the temperature graphs in [Figs. 5 and 6](#) shows that the sequence is almost reversed such that the position of highest temperature with low air flow almost became the position of lowest temperature with high air flow. The fire was positioned on the air inlet side and with low airflow the temperature was highest on this side of the ceiling. At high airflow most of the smoke was sucked out via the air vents and trash can hole before reaching the ceiling in the toilet compartment. The detectors at the ceiling were about 20 s faster than the detectors under the sink with the low fan speed configuration, but

Table 5
Positions of detectors, thermocouples and obscuration meters in the mockups.

	Positions
Point smoke detector	1, 2, 4, 5, 7, 9
Point smoke/heat detector	1, 2, 5, 6, 7, 8
Aspirating smoke/heat detector	2, 4, 6
Aspirating smoke detector	1+4, 5+9
Thermocouples (TC)	1, 2, 3, 4, 5, 6, 7, 8
Obscuration meters	1+2, 4, 5

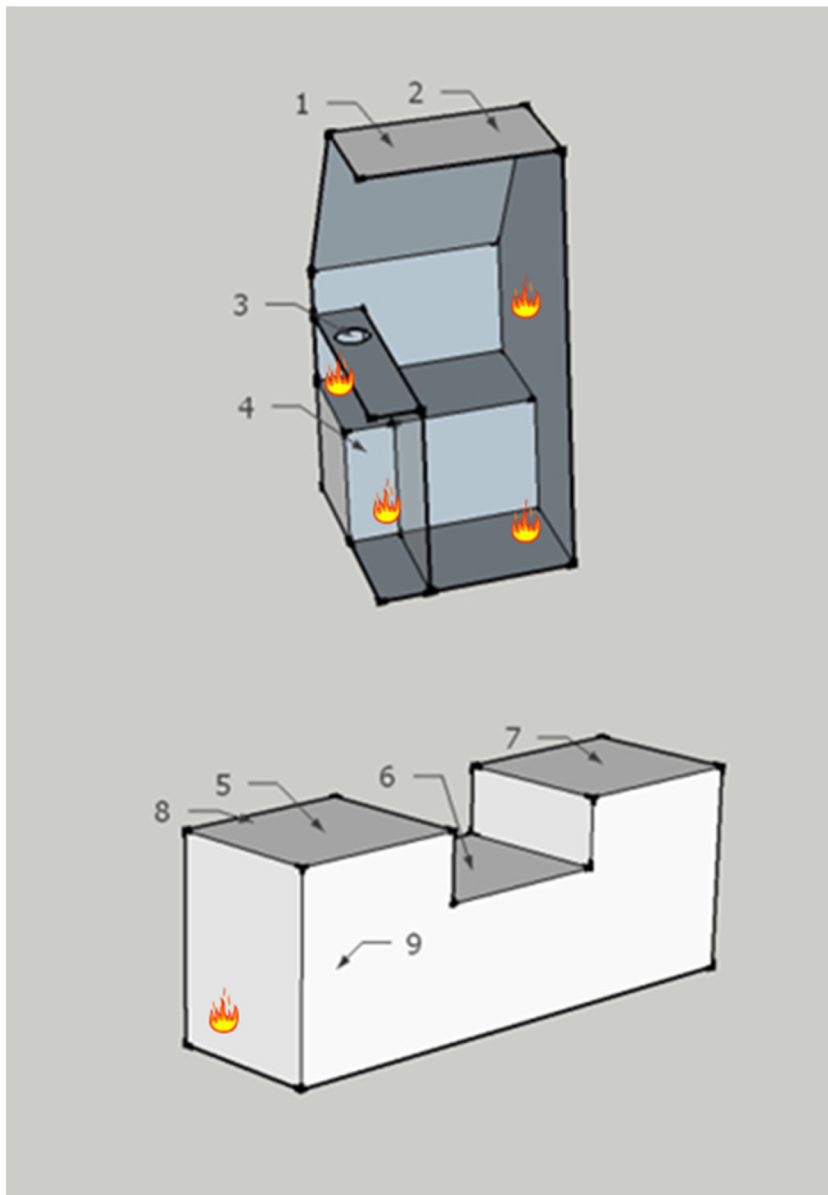

Fig. 3. Drawing on positions. Fire positions are marked for paper (trash can) and plastic/rubber fire in the concealed space, heptane pool fire on the floor and cigarette through the wall in the toilet compartment and the mattress fire in the sleeping compartment.

with the high air flow it was about the same response times for all detectors except those positioned on the air inlet side of the ceiling which were now about 20 s slower in response time. Notable is that the higher air flow does not affect the aspirating detectors as much as the point smoke detectors. The reason that the thermocouple under the sink started some degrees higher than the others was that the fire tests were run with short interval and some heat remained in the ceiling of this small concealed space.

3.4. Plastics/rubber tests

The results of the plastics/rubber tests were similar to the results of the paper tests in the trash can, which means that with high air flow no heat or smoke at all entered the main toilet compartment space while with low air flow the smoke broke through the air-barrier. The only difference was that the smoke production was so much higher than in the paper fire that also the detectors in the ceiling were activated quite fast in the low fan speed test.

Table 6

Detectors response times for different tests and positions. The response times are given in seconds after ignition.

"ND" = No detection "–" = Not included "s" = smoke sensor "h" = heat sensor		Toilet compartment							Sleeping compartment		
		Cig.		Trash can		Heptane pool		Plastics & rubber		Mattress	
		Low fan	Low fan	High fan	Low fan	High fan	Low fan	High fan	High fan	No fan	
Detectors	Pos.	Test 1	Test 2	Test 3	Test 4	Test 5	Test 6	Test 7	Test 8	Test 9	
Point smoke det.	1	ND	ND	ND	27	43	57	ND	-	-	
	2	ND	ND	ND	32	61	69	ND	-	-	
	4	ND	42	45	46	47	39	37	-	-	
	5	-	-	-	-	-	-	-	55	55	
	7	-	-	-	-	-	-	-	63	76	
	9	-	-	-	-	-	-	-	85	76	
Point smoke/heat det.	1 s	ND	ND	ND	41	30	32	ND	-	-	
	1 h	ND	ND	ND	82	56	ND	ND	-	-	
	2 s	ND	ND	ND	25	56	39	ND	-	-	
	2 h	ND	ND	ND	32	ND	ND	ND	-	-	
	5 s	-	-	-	-	-	-	-	45	37	
	5 h	-	-	-	-	-	-	-	64	74	
	6 s	-	-	-	-	-	-	-	52	44	
	6 h	-	-	-	-	-	-	-	76	80	
	7 s	-	-	-	-	-	-	-	57	56	
	7 h	-	-	-	-	-	-	-	122	ND	
8 s	-	-	-	-	-	-	-	29	19		
8 h	-	-	-	-	-	-	-	56	73		
Asp. smoke/heat det.	2 s	ND	ND	ND	25	38	33	ND	-	-	
	2 h	ND	ND	ND	ND	ND	ND	ND	-	-	
	4 s	ND	21	21	40	36	12	21	-	-	
	4 h	ND	ND	ND	ND	ND	ND	ND	-	-	
	6 s	-	-	-	-	-	-	-	53	39	
	6 h	-	-	-	-	-	-	-	ND	ND	
Asp. smoke det.	1+4	51	52	54	43	46	46	50	-	-	
	5+9	-	-	-	-	-	-	-	45	48	

3.5. Mattress tests

In the mattress tests the fire was positioned in the fan section of the sleeping compartment, such that the smoke had to move against the air flow to reach the air inlet section. The main goal of this test was to see the time difference between detection in the fan section and in the air inlet section with and without the impact of a fan. Contrary to expectations detection in the air inlet section was facilitated by the fan, due to the fact that the fan caused circulation inside the sleeping compartment. The time difference between detection in the fan section and the air inlet section increased from about 10 s to about 20 s when turning off the fan.

The mattress fire source was analyzed further regarding toxic elements in the fumes, see right side in Fig. 7. The mattress was ignited under the hood of the cone calorimeter [15] (with the conical heater removed) and the toxic fumes were analyzed with a FTIR-spectrometer (Fourier Transform Infrared Spectroscopy). High levels of carbon dioxide (CO₂), carbon monoxide (CO), hydrogen cyanide (HCN), and nitric oxide (NO) were detected from the mattress. As expected, the concentration of toxic elements in the fumes followed the smoke obscuration curve, which means that they may be related to the obscuration measurements in the sleeping compartment mockup. The short-term exposure limits set out by the occupational health authority in Sweden ("Arbetsmiljöverket") [16], i.e., acceptable levels for 15 min exposure, were reached at about 0.5–3 dB/m smoke obscuration for the mattress fire source. This is the point where most smoke detectors initiate an alarm (including entry delay and processing time of the detector). At 10 dB/m smoke obscuration, reached in the tests after 1.5–2 min from the ignition, high levels of toxic substances were measured: about 5% CO₂, 800 ppm CO, 70 ppm HCN, and 250 ppm NO. This is about 5–8 times higher than the short-term exposure limits and according to the National Institute for Occupational Safety and Health (NIOSH) these levels are immediately dangerous to life and health. Their listed IDLH (Immediately Dangerous to Life and Health) values of the mentioned substances are 4% of CO₂, 1200 ppm of CO, 50 ppm of HCN, and 100 ppm of NO [17]. The response times of the detectors in these tests were around 60 s, which do not give much time left for evacuation.

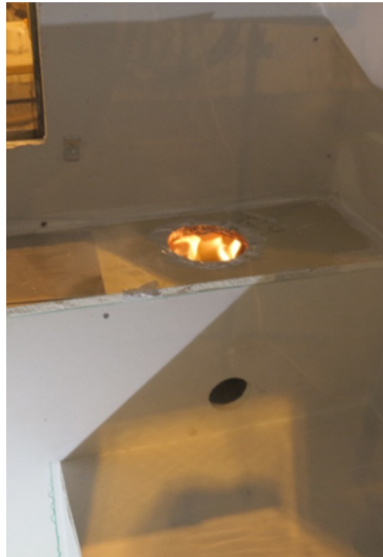

Fig. 4. Paper fire in the trash can, seen from inside the toilet compartment.

4. Discussion and conclusions

According to the new UNECE Reg. no. 107 requirement smoke or heat detectors shall be installed in toilet compartments and driver sleeping compartments of buses. The performed tests have resulted in valuable information of what to consider when installing these detectors. Smoke detectors are generally much faster than heat detectors, which is also confirmed in all tests performed in this study. In the tests the fires have developed quite rapidly, but for slow growing fires the benefit of smoke detectors compared to heat detectors will be even greater. There are locations where heat detection may be considered, e.g., in the concealed space under the sink in toilet compartments or close to the trash can where the detector is expected to be in the immediate vicinity of the fire. In both the paper test and the plastic/rubber test the temperature in the concealed space under the sink was over 100°C after one minute. In very narrow spaces and in other circumstances when the detector is close to the potential fire source heat detectors will also react relatively quickly, although smoke detectors will most often still be faster. The benefits of using heat detectors in these spaces are that they are usually cheaper and more robust. They may also require less maintenance and inspections than smoke detectors that must be inspected regularly to ensure proper functioning. However, heat detectors should only be used as a complement to smoke detectors.

In toilet compartments it is common to install a smoke detector in the ceiling, but the tests clearly shows that with an operating fan it could be difficult to detect a trash can fire or cable fire solely with a detector in the ceiling. However, the fan may be malfunctioning resulting in the smoke being transported upwards and not into the concealed space. In such case a detector in the concealed space would be of limited use while a detector in the ceiling would be more effective. There might also be other fire scenarios than those tested in this work. Therefore a detector in the ceiling is useful as a part of an integral detector system. This study suggest that the detection system in bus toilet compartments should consist of at least a smoke detector in the ceiling and heat or smoke detector in the concealed space of the fan, especially if this space also contains the

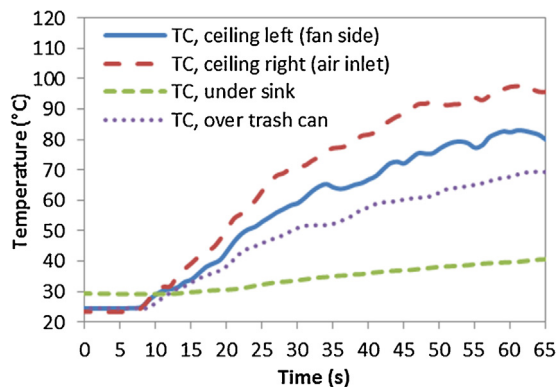

Fig. 5. Temperatures of thermocouples (TC) in Test 4: heptane pool fire, low fan speed.

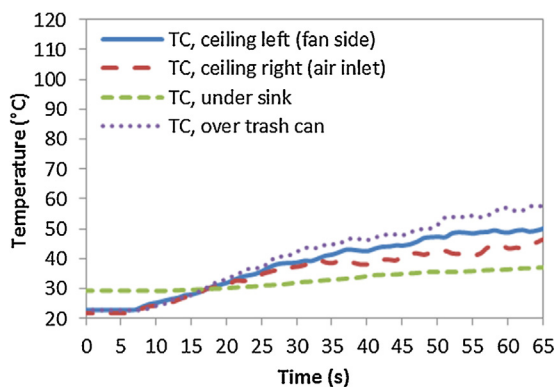

Fig. 6. Temperatures of thermocouples (TC) in Test 5: heptane pool fire, high fan speed.

trash can. Two detection points like this is very common in toilet compartments of airplanes [18]. In the Hannover bus fire with 20 casualties [5] the fire started in a cable somewhere beneath the toilet and even though a fire detector, regardless of position, would have been a first step of improvement, the position could have been critical for achieving enough time for evacuation.

If smoke detectors are used in many spaces the use of aspirating systems could be considered instead of point smoke detectors. The benefit of this approach is that only one detector is needed and the system samples air from e.g., both the ceiling and other spaces in the toilet compartment. More advanced aspirating systems could potentially also sample air from different locations around the entire bus. An aspirating smoke detector in the toilet compartment ceiling also has a great advantage in that the detector is hidden and protected. According to the bus operators they have problems with passengers pulling down the detectors.

Another important design consideration when installing detectors in the toilet compartment ceiling is the need to avoid the air flow from the air inlet. The tests have shown that the detection time may be delayed considerably, and the delay time may be even larger for slow growing fires. Notable is that the higher air flow does not affect the aspirating detectors as much as the point smoke detectors.

In the sleeping compartment tests the response time difference between different detector placements was relatively small, which indicates that one detector may be satisfactory. However, for rapid detection the use of two smoke detectors should be considered if the decreased ceiling height in the middle section is considerable.

The conclusions above are based on the presented tests, which include assumptions and design parameters with a degree of uncertainty and variability. Each fire scenario was run twice and the temperature deviations could for some fire scenarios be more than ± 50 °C, but for stable fires as the heptane pool fire it was not more than ± 10 °C. However, in all tests the sequences in which the detectors activated and if the detector did not activated were the same for both tests and it is this information that is used for the conclusions. If the design parameters are changed the result could be different, but the tests were performed such that the conclusions should be relevant for most toilet compartments. Regarding important parameters as air flow and location of air inlet and outlet the tests are focused on the most interesting configurations of those

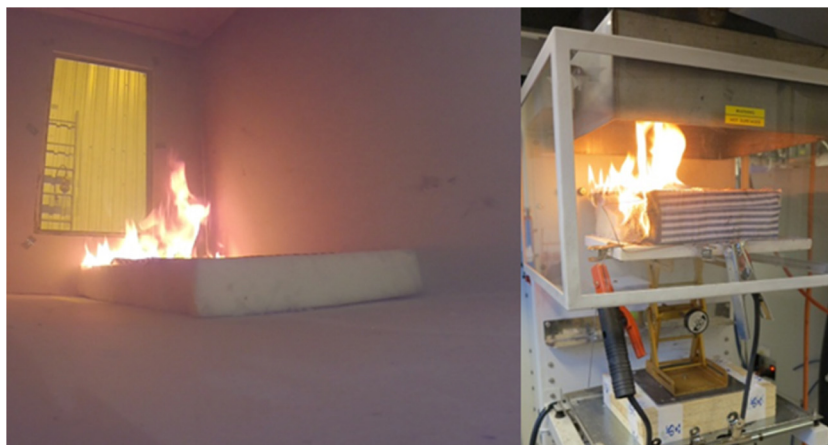

Fig. 7. Mattress fire source in the sleeping compartment mockup (left) and in the calorimeter setup (right).

that are common. However, when installing detectors in compartments very different from the configurations of these tests, it is important that the compartment is further analyzed with the conclusions in this paper in mind.

Acknowledgment

This work was financed by the FFI program of the Swedish Governmental Agency for Innovation Systems, VINNOVA.

References

- [1] N.R. Meltzer, G. Ayres, M. Truong, *Motorcoach fire safety analysis: the causes, frequency, and severity of motorcoach fires in the United States*, Fires in Vehicles—FIVE 2012, Chicago, USA, 2012.
- [2] The Office of Transport Safety Investigations (OTSI), *Bus Safety Investigation Report—An Investigation into Bus Fires in NSW 2005–2012*, 2013.
- [3] R. Hammarström, J. Axelsson, M. Försth, P. Johansson, B. Sundström, *Bus Fire Safety*, SP Technical Research Institute of Sweden, SP Report 2008, 41, 2008.
- [4] E. Kokki, *Bus fires in 2010–2011 in Finland*, Fires in Vehicles—FIVE 2012, Chicago, USA, 2012.
- [5] R. Damm, *The Hannover bus fire and activities on improving fire safety in buses*, Fires in Vehicles—FIVE 2010, Gothenburg, Sweden, 2010.
- [6] P. Blomqvist, *Emissions from fires—consequences for human safety and the environment*, Doctoral Thesis, Lund University, Lund, 2005.
- [7] J. Brandt, M. Försth, *Testing active fire protection systems for engine compartments in buses and coaches—a pilot study*, SP Technical Research Institute of Sweden, SP Report 2011, 22, 2011.
- [8] P. Smith, A. Chattaway, J. Peoples, *A comparison of various fire detection methodologies in transit vehicle engine compartment fire protection systems*, SAE Int. J. Commer. Veh. 5 (1) (2012) 343–353, doi:<http://dx.doi.org/10.4271/2012-01-0983>.
- [9] R. Ochoterena, M. Hjohlman, M. Försth, *Detection of Fires in the Engine Compartment of Heavy Duty Vehicles, A Theoretical Study*, SAE Technical Paper 2014-01-0423, doi:[10.4271/2014-01-0423](https://doi.org/10.4271/2014-01-0423), 2014.
- [10] *Bus fire due to toilet ruling*, [Online]. Available: <<http://www.dailyexpress.com.my/news.cfm?NewsID=88185>> (accessed 17.04.14).
- [11] R. Seales, *Miracle escape for dozens of school children as they flee blazing bus after toilet caught fire*, [Online]. Available: <<http://www.dailymail.co.uk/news/article-2107120/Miracle-escape-dozens-school-children-flee-blazing-bus-toilet-caught-fire.html>> (accessed 17.04.14).
- [12] UNECE Regulation No. 107—Rev. 3—Amend. 4, *General construction of buses and coaches*, [Online]. Available: <<http://www.unece.org/fileadmin/DAM/trans/main/wp29/wp29regs/R107r3am4e.pdf>> 2012.
- [13] O. Willstrand, J. Brandt, R. Svensson, *Fire detection & fire alarm systems in heavy duty vehicles, WP5—Fire detection in bus and coach toilet compartments and driver sleeping compartments*, SP Report 2014, 28, 2014.
- [14] Fire Industry Association (FIA), *Ionisation Chamber Smoke Detectors (ICSD): Applicable regulations for manufacturing, transport and disposal*, FIA Fact File No. 0017, 2005.
- [15] The International Organization for Standardization (ISO), *ISO 5660-1, Reaction-to-fire tests—Heat release, smoke production and mass loss rate—Part 1: Heat release rate (cone calorimeter method)*, 2002.
- [16] Arbetsmiljöverket, *Kemiska arbetsmiljörisiker*, AFS 2011:19, ISBN 978-91-7930-560-4, ISSN 1650-3163, 2011.
- [17] National Institute for Occupational Safety and Health (NIOSH), *Documentation for Immediately Dangerous To Life or Health Concentrations (IDLHs)*, 1994. [Online]. Available: <<http://www.cdc.gov/niosh/idlh/intridl4html/>> (accessed 2.04.14).
- [18] J. Stonegård, M. Svensk, *Fire detection and fire alarm systems in trains and aircrafts, a pilot study*, Bachelor Thesis, Luleå University of Technology, 2013.