

EXTERIOR DEFORMATION MEASUREMENT USING GPS FOR SAFETY MANAGEMENT OF EMBANKMENT DAMS

**Yoshikazu YAMAGUCHI¹ and Toshihide KOBORI² and Ichiro IKEZAWA³
Motoharu YOKOMORI⁴ and Tomoharu IWASAKI⁵**

INTRODUCTION

Among measurements now performed for safety management of embankment dams, measurements of behaviors that indicate the overall state of a dam, such as measurements of the quantity of seepage through the dam body and the shallow parts of the foundation bedrock and measurements of exterior deformation are most important.

Exterior deformation of an embankment dam is measured by forming a grid of appropriately spaced measurement lines on the crest and slopes of the dam and establishing measurement use targets at each grid intersection point, to measure the exterior deformation by surveying the quantity of displacement in the horizontal and vertical directions. However, by using the above method, rapidly responding after an earthquake or in other emergencies is difficult.

The global positioning system (GPS) is a system that can perform surveys quickly at relatively low cost. GPS is an all-weather positioning system using satellites that is well known for its role in car navigation and in surveying applications.

In recent years, GPS based surveys have achieved sweeping improvements in measurement precision by eliminating man-made noise that accompanies transmitted signals (Selective Availability SA), establishing a 24-hour measurement system by increasing the number of artificial satellites, advancing electric instruments that improve the SN ratio (signal to noise ratio) and increase antenna sensitivity, achieving great progress in calculation functions that instantly analyze signals received from GPS and boosting measurement data error treatment technology.

This research responds to the above circumstances by performing and comparing conventional exterior deformation measurements based on geodimeter surveys and on leveling surveys with exterior deformation measurements by GPS at an existing embankment dam, and based on the results, considering the possibility of using GPS to supplement exterior deformation measurements for embankment dams and specific challenges to be overcome to replace conventional methods with the GPS method in the future.

EXTERIOR DEFORMATION MEASUREMENTS FOR EMBANKMENT DAMS IN JAPAN

Measurements for safety management of dams must be capable of accurately confirming safety of dam bodies and foundation bedrock in conjunction with visual inspection patrols. The Cabinet Order Concerning Structural Standards for River Management Facilities (Japan Institute of Construction Engineering, 2000) stipulates items that must be monitored for safety management of a dam in Japan.

For embankment dams, the quantity of seepage through the dam body and shallow foundation

bedrock and their exterior deformation are stipulated as major measurement items for safety management. This stipulation is made because measurement of these items can clarify overall behavior of the dam body and the foundation bedrock; not localized behavior limited to a specified section. In addition, instruments that are safe from malfunctions are used to measure these items (Committee on Dam Management, 1999). Committee on Dam Management

Figure 1 shows an example of the installation of exterior deformation measurement use targets on a rockfill dam with an earth core that is one type of embankment dam. Figure 2 shows an example of the detailed structure of targets at measuring point and benchmark. Specifically, a grid of appropriately spaced measurement lines is formed on the crest and slopes of a dam body, measurement use targets (measuring point) are installed at each grid intersection point, and the quantity of displacement in the horizontal and vertical directions of the targets (measuring point) from targets installed on the left and right banks (benchmark) are measured based on geodimeter survey and on leveling survey.

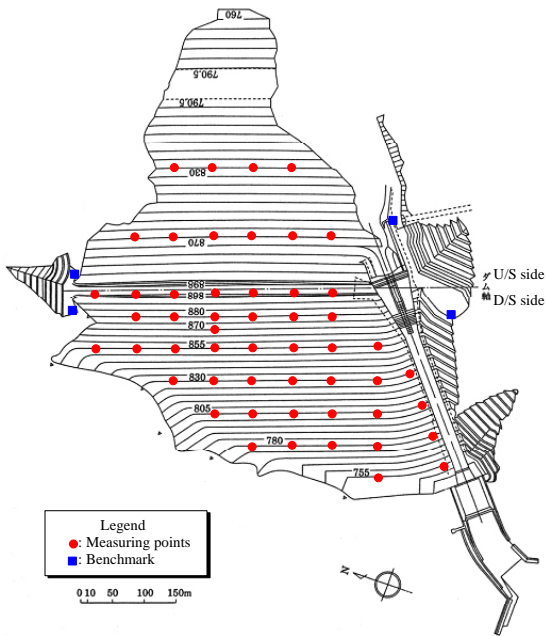

Figure 1 Example of the installation of exterior deformation measurement use targets on a rockfill dam (Naramata Dam)

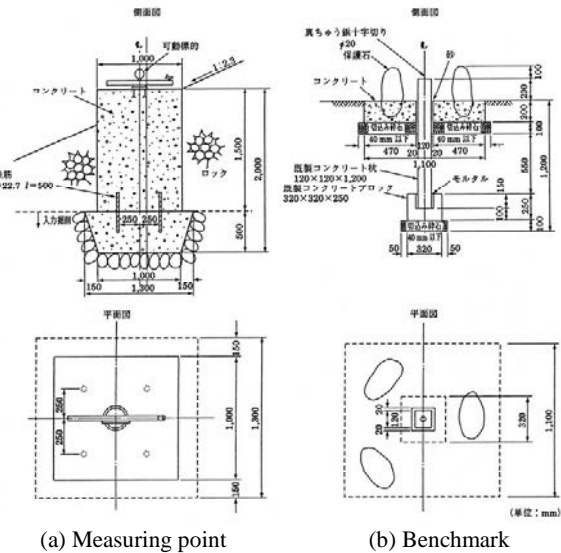

Figure 2 Example of the detailed structure of targets at measuring point and benchmark (Sagae Dam)

Table 1 summarizes the frequency of measurement for dam safety management in Japan (Japan Institute of Construction Engineering, 2000). The deformation of the embankment dam in Table 1 shows exterior deformation. First Term of dam safety management refers to the duration of first filling of the dam reservoir. The period from the conclusion of the first filling until the stable stage when the dam's behavior has stabilized and the period after the dam's behavior has reached the stable behavior stage are called Second Term and Third Term respectively of dam safety management. The measurement of exterior deformation of an embankment dam is done once a week in First Term, once a month in Second Term, and once every three months in Third Term. There are no detailed regulations concerning the precision of the measurement of exterior

deformation of an embankment dam, but it is believed that precision in millimeter units is necessary.

Methods of measuring exterior deformation of embankment dams based on geodimeter and leveling surveys have faced some problems in the past. It is relatively time-consuming and expensive to perform measurements and to analyze the results with these methods, and as a result of the time and cost, it is not always possible to respond promptly to the need for urgent measurements of exterior deformation after an earthquake or in other emergencies.

Table 1 Frequency of measurement for dam safety management in Japan

Measurement item	Concrete Dam			Rockfill Dam		
	First Term	Second Term	Third Term	First Term	Second Term	Third Term
Leakage / Seepage	Once / 1 day	Once / 7 days	Once / 1 month	Once / 1 day	Once / 7 days	Once / 1 month
Deformation	Once / 1 day	Once/1 day	Once / 7 days	Once / 7 days	Once / 1 month	Once / 3 months*
Uplift / pore water pressure	Once / 1 day	Once / 7 days	Once / 1 month	-	-	-
Visual inspection	Once / 1 day	Once / 7 days	Once / 1 month	Once / 1 day	Once / 7 days	Once / 1 month

*: The interval of the measurement can be elongated according to conditions.

GPS MEASUREMENT TECHNOLOGY

Present state of GPS measurement technology

Recently a method of obtaining precision of from 1mm to 2mm that is several times higher than the precision of conventional GPS has been developed: measuring displacement continuously for 24 hours with GPS and processing the measurement results by a trend model that is one kind of statistical smoothing method (Matsuda *et al.*, 1998). In addition, a new GPS measurement system specialized in geotechnical engineering field has been developed (Iwasaki *et al.*, 2002). And using the Internet for data communication lowers communication costs and improves convenience, permitting high-precision GPS automatic displacement measurement at relatively low cost.

Newest GPS measurement system

The system used for this research was a compact, lightweight, and low cost GPS measurement device newly developed for the measurement in geotechnical engineering field and a monitoring center established based on the Internet. Figure 3 illustrates an outline of the newest GPS measurement system used in geotechnical engineering field.

First, GPS sensors and the communication base system are installed at the site. The measured data received by the GPS sensors are sent to the communication base system and are then transmitted to a monitoring center through an ISDN circuit or other public circuit. At the monitoring center, reference line analysis is performed based on static positioning (assuming that displacement does not occur during measurement, data for between about 1 and 3 hours is used for positioning, achieving precision of 5 to 10mm + 1ppm × reference line length in the horizontal direction, and precision of 10 to 20mm + ppm × reference line length in the vertical direction), errors are processed by the trend model described below, and the results are summarized on a displacement

graph and plane vector chart etc. These measurement results are distributed to managers of the monitored structure through the Internet.

The benefit of this method is that GPS measurement data obtained from various parts of Japan are analyzed at a single monitoring center, keeping the cost of analysis per site extremely low. And because the ability to use the internet permits monitoring of measurement results regardless of the time and place (even using cellular phones), it supports monitoring at night when there are few personnel and can reduce communication costs.

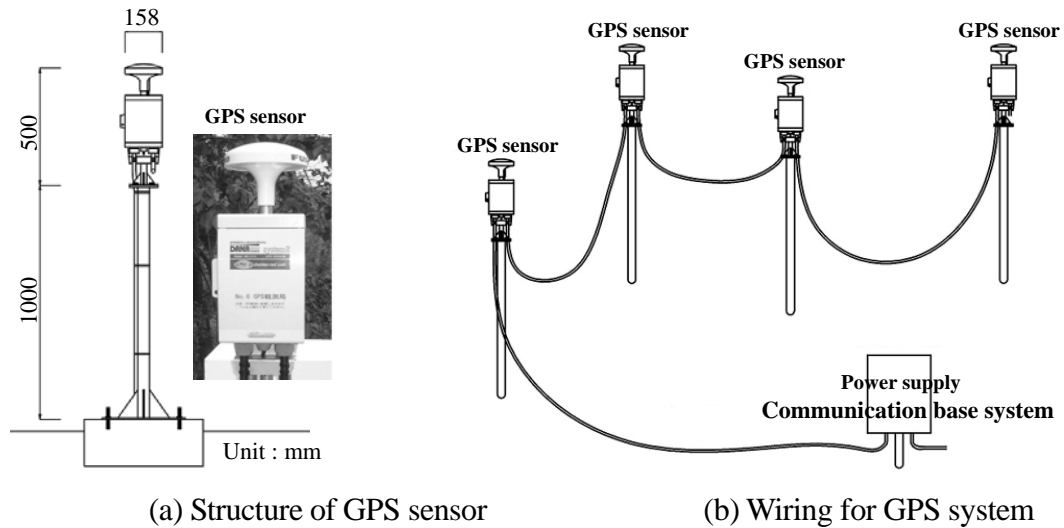

Figure 3 Outline of the newest GPS measurement system used in geotechnical engineering field

Improvement of measurement precision by a trend model

When a GPS measurement is done, the measurement results are scattered so it is difficult to judge displacement in units of a few millimeters by the highest precision static positioning using only reference line analysis, because of error factors such as satellite arrangement, atmospheric visibility, reference line length (intervals between reference points and measurement points), meteorological conditions, multi-pass (waves reflected by buildings or objects on the ground). So the system used for this research introduced time series statistical processing (error processing) based on a trend model proposed by Matsuda *et al.* (1998).

This method is using a time series analysis model with a stochastic structure called the trend model to estimate actual displacement behavior based on measurement data including noise. Specifically, a model that treats the actual displacement u_n of the n^{th} measurement point that is to be estimated as a parameter of the system equation that is called the trend constituent model and that positions the displacement y_n that is actually measured as the observation equation, and is established as follows is used.

$$\Delta \kappa u_n = v_n \quad (\text{system equation}) \quad (1)$$

$$y_n = u_n + w_n \quad (\text{observation equation}) \quad (2)$$

But, v_n is the system noise with an average value of 0 and standard deviation of τ , w_n is the observation noise with average value of 0 and standard deviation of σ , and both follow a normal distribution. The symbol Δ is the time difference calculation logical element and $\Delta \kappa$ signifies the κ^{th} differential. The analysis is done by smoothing the measured value by applying the Karman

Filter algorithm to the trend model and by obtaining the dispersed values of observation noise and the system noise by the maximum likelihood estimation. And the model degree κ is estimated so that AIC (Akaike Information Criterion) (Suzuki, 1998) is the minimum possible value.

Odera *et al.* (1998) installed GPS sensors on a cut slope along an expressway, performed forced displacement testing (forcefully displacing the GPS sensors within a range of 2mm to 10mm), and performed error processing of the GPS measured values using a trend model, revealing that it is possible to measure displacement with accuracy of about 2mm. Besides, Iwasaki *et al.* (2002) performed error processing of GPS measurement values of a landslide using a trend model, confirming that it is possible to measure landslide displacement within a range of 1mm to 2mm/month by comparing the results with those obtained by geodimeter surveys and by ground surface extensometer readings.

The above reveals that this system can obtain displacement detection precision of approximately 1mm to 2mm by error processing using a trend model.

MEASUREMENT AT HANEJI DAM

Outline of the trial measurements

The Haneji Dam where the trial measurements were done is a rockfill dam with a central earth core, dam height of 66.5m, and dam crest length of 198m constructed in the northern part of the main island of Okinawa by the Okinawa General Bureau of the Cabinet Office, the Japanese Government. The first filling of the dam reservoir was done from July 2001 through June 2004 after its completion (First Term in safety management).

The exterior deformation of the dam body was measured by the conventional geodimeter and leveling surveys at a measurement frequency of once a week. After the first filling, the dam switched to measurement system for Second Term in safety management, and measurements of the exterior deformation of the dam body have continued at an interval of once a month. GPS measurement began on October 10, 2003 during the first filling.

Figure 4 shows the layout of the measurement points on the dam body. Of the movable point targets at 19 locations, GPS sensors were installed at four locations (S-8, 9, 12 and 13) near the center of the dam body. And GPS use reference points were newly installed on the mountain ridge line beside the dam body with immovable ground and good visibility from the sky above. The measurement conditions were good, with distance from the reference points to each measurement point (reference line length) from 103.2m to 147.6m, and all measurement points able to constantly capture between 4 and 6 satellites.

Figure 5 shows the method of installing GPS sensors at locations S-8 and S-12. The GPS sensors at S-8 and at S-9 were installed in the movable point target concrete that is embedded in the rock zone. At S-12 and S-13, nearby survey targets were buried in the sidewalk on the dam crest, so the GPS sensors were anchored on the base of stockade on the shoulder of the crest sidewalk.

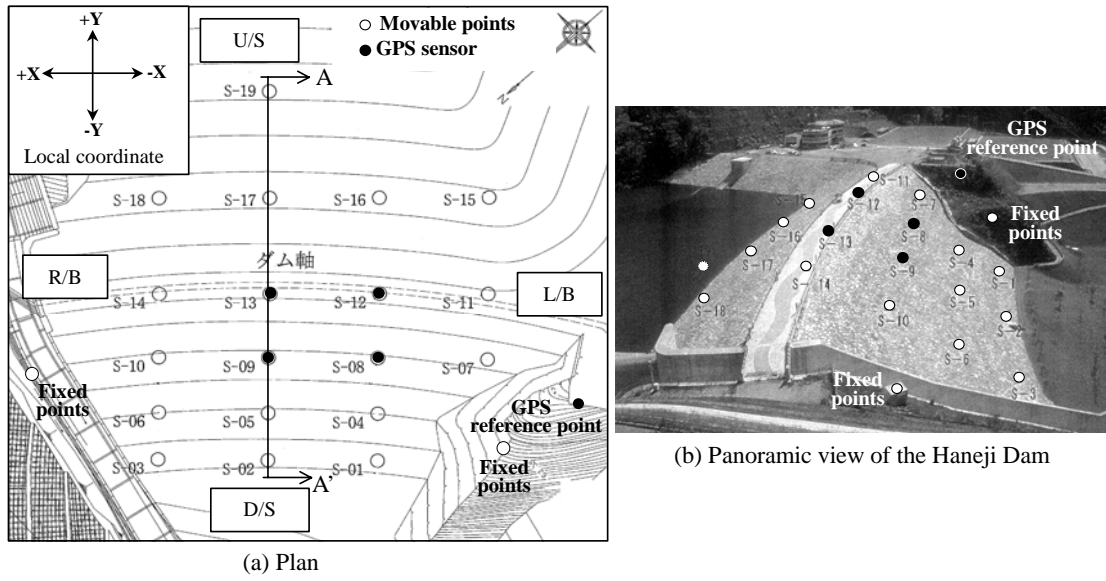

Figure 4 Arrangement of measurement points

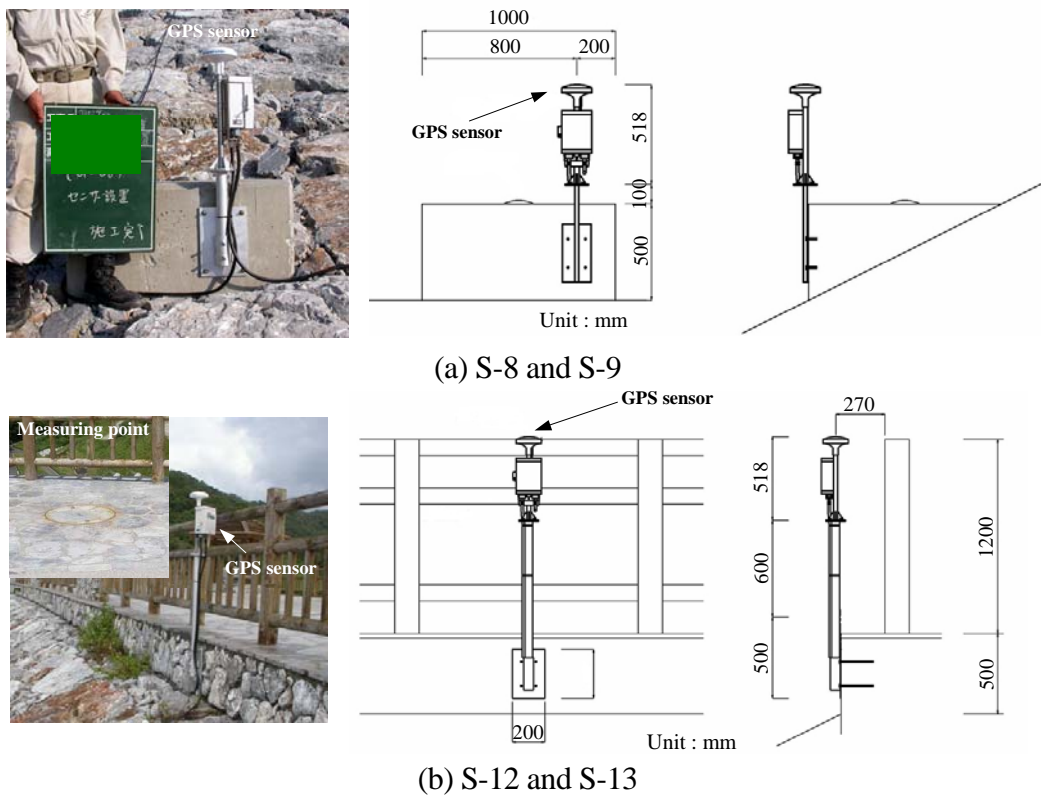

Figure 5 Installation conditions of GPS sensors

Results measured by GPS and conventional methods

As examples of measured results, Figure 6 (a) and (b) present comparisons of the results of GPS measurement with the results of geodimeter survey and leveling survey made at S-8 installed on the middle of the downstream slope of the dam and at S-12 near the dam crest respectively. The measurement period was about one year from October 10, 2003 to October 5, 2004. From the top of the figure, changes over time of displacement in the X (dam axis) direction, that in the Y (upstream-downstream) direction, that in the vertical direction, were shown. And at the bottom level, the change over time of the dam reservoir water level was illustrated. The displacements were plotted with the GPS measurement start point treated as zero. The black circles in the displacement graph show the results of geodimeter and leveling surveys, the dots show the results of GPS measurements before error processing, and the solid line shows the results of the GPS measurements of 1 point per 1 hour after error processing by the trend model. Displacement in the X direction, Y direction, and vertical direction are plotted with the right bank, dam upstream, and upward directions respectively considered positive.

First, the measurement results before error processing and after error processing of GPS measurements are studied. The GPS measurement values before error processing (dots) are distributed about 5mm in the X direction and the Y direction, and over a range from about 10mm to 15mm in the vertical direction (2 to 3 times the X and Y directions). Such scattering of measured values is a result of the impacts of the ionosphere and the troposphere and the track error of the satellite that cannot be fully removed by the normal GPS reference line analysis, plus noise of the GPS receiver, and other causes of error. But, the GPS measurement value after error processing (solid line) by the trend model fluctuated less than 1mm, and its fluctuation width is from 1/5 to 1/10 of the distribution range of the measured value before error processing, revealing that good error processing is performed.

Next, the results of GPS measurement, geodimeter survey, and leveling survey are compared.

The GPS sensor at S-8 was installed in movable point target concrete that was embedded in the rock zone (see Fig. 4(a)). Therefore, the results of GPS measurement and of geodimeter and leveling surveys can be directly compared as measured values at identical points on the slope of the dam body. It can be concluded that the GPS measured values after error processing at S-8 and the values of the geodimeter and leveling surveys generally conform. In the vertical direction in particular, the GPS measurement values after error processing and the leveling survey values were almost identical throughout the entire measurement period, revealing that both were accurate measurements. But in the X direction and Y direction, the measured values from the geodimeter surveys were far more scattered than the GPS measurement values after error processing.

In the geodimeter survey, a measurement error is caused by the range error produced by differences in refraction resulting from angle measurement errors of the range finder and from atmospheric density. To deal with the atmospheric density in particular, actual surveying work is done by, in addition to measuring the atmospheric temperature and pressure etc. to perform atmosphere correction, being sure to do the work from before dawn to early morning when the atmosphere is relatively stable in order to reduce the impacts of diurnal change and annual fluctuation of atmospheric density, but when actually measuring exterior deformation of

embankment dam bodies, it is difficult to completely eliminate the impacts of the atmosphere from all survey work, because surveys are done at many points throughout the year. So the measurement precision of a geodimeter survey is a little inferior to that of a leveling survey. It is assumed that the measurement precision of the geodimeter survey in these trial measurements was a little inferior to the precision of the GPS measurement and the leveling measurement for this reason.

GPS measurements done performing only conventional reference line analysis often obtain lower measurement precision than a geodimeter measurement. In these measurements, the GPS measurement values before error processing were more scattered than those of the geodimeter survey. But the GPS measurement values after error processing were more precise and less scattered than in the results of the geodimeter survey because this system obtains a vast quantity of measurement values by continuous automatic measurements (continuous measurements at a rate of one/hour) permitting error processing by a trend model, effectively omitting the errors included in the GPS measurement values.

In the S-12 measurement results, the GPS measurements and the geodimeter and leveling survey values generally conform, but in the vertical direction, errors from approximately 2mm to 5mm were confirmed in the GPS measurement and leveling survey measurement values. This is hypothesized to be a result of various factors: because the S-12 movable point target was embedded in the sidewalk on the dam crest, the GPS sensor could not be installed at the same location as the movable point target, and because the GPS sensor was fixed in the base of stockade on the shoulder of the dam crest sidewalk (see Fig. 4(b)), it might be impossible to accurately measure the behavior of the dam body by the GPS measurement values.

Comparing the GPS measurement with the geodimeter and leveling surveys at the dam body crest and a method of burying a GPS sensor in the dam crest are future challenges.

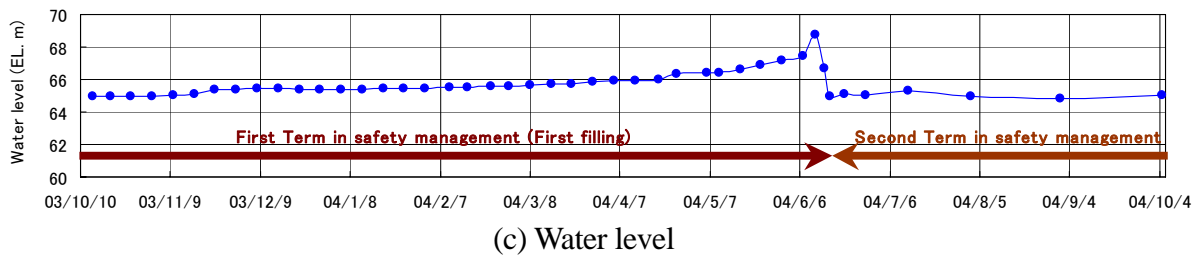
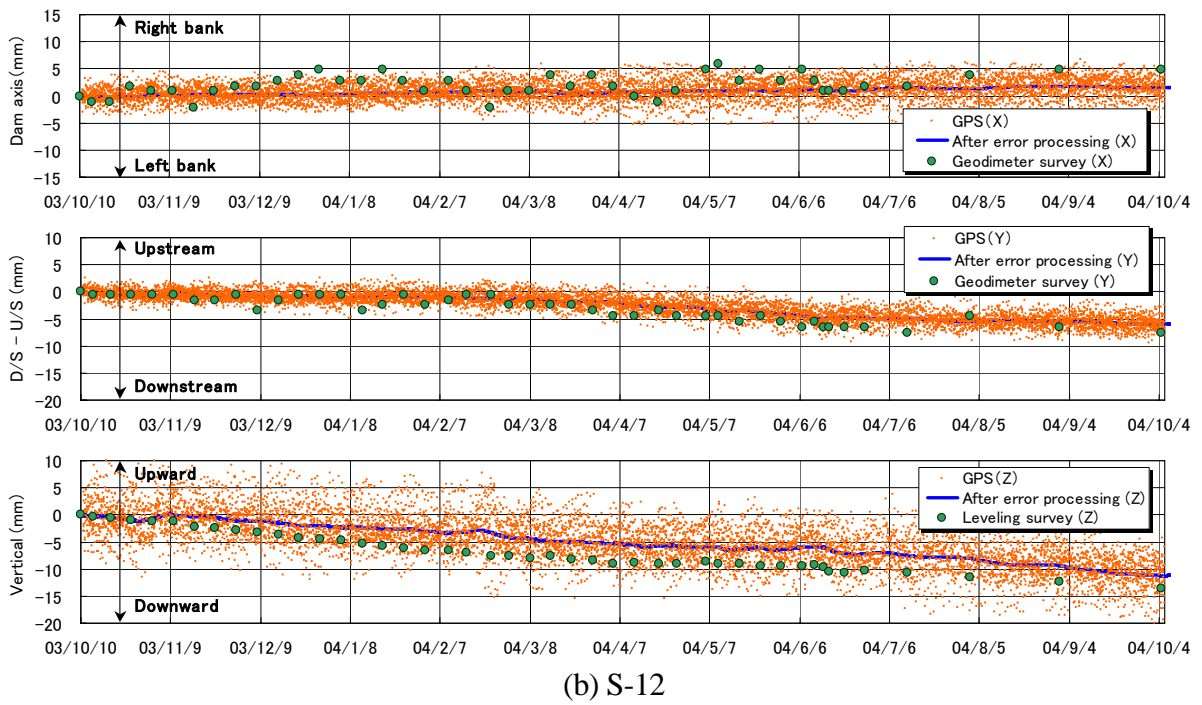
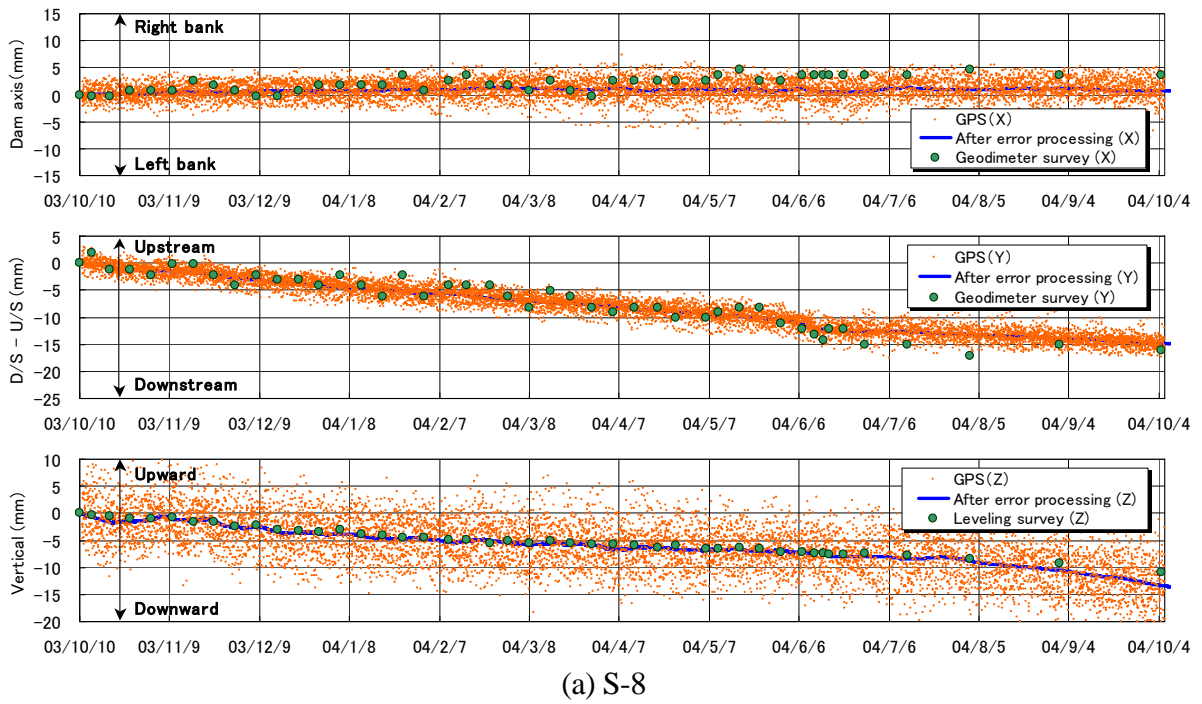

Figure 6 Results of GPS measurement with the results of geodimeter survey and leveling survey

EMBANKMENT DAM EXTERIOR DEFORMATION MEASUREMENTS BASED ON GPS

Below, the methods used to measure exterior deformation of embankment dams by GPS and future challenges to this method are considered based on the results of the trial measurement.

- (1) The frequency of exterior deformation measurements of embankment dams by the conventional geodimeter and leveling surveys is once a week considering the time and cost required even during first filling when the quantity of deformation is highest and past incidents at past embankment dams have occurred most often (Committee on Dam Management, 1999). Past experience with embankment dams operated in Japan reveals no cases where the measurement frequency of exterior deformation of embankment dams was viewed as a problem. But applying the GPS measurement system used for this research allows measurements at intervals so short (once an hour) that they are almost real time at measurement precision equal to or superior to that of conventional methods, permitting even more precise safety management .
- (2) This GPS measurement system more effectively displays its strong point: namely that it permits almost real time measurement of displacement in an emergency such as the abrupt rise of the reservoir water level during a large scale flood or when a large earthquake has occurred. In 1999, the notices on first filling of dam reservoirs (draft) was enacted (Development Department , 1999) in Japan, eliminating the established restrictions on the rate of increase of reservoir water level during the first filling, and since the Hyogoken-Nambu Earthquake in 1995, the need for methods of immediately inspecting civil engineering structures after a large earthquake has been discussed and the applicability of GPS measurement systems has steadily risen.
- (3) The GPS measurement system used for this research was an inexpensive GPS measurement instrument that achieved compactness, light weight, and low price without any decline of its measurement precision based on the optimum instrument configuration achieved through the modification of an expensive measurement use GPS system by removing all functions and parts not needed in geotechnical engineering field. The system also sharply lowered personnel costs and analysis costs from the level required by conventional measurement methods. Therefore, at newly constructed dams in particular, introducing this system during the first filling that corresponds to First Term in safety management when the stipulated measurement frequency is high (once a week) can sharply reduce measurement costs.
- (4) When GPS measurement is done, the degree of visibility of sensors from the sky above, presence/absence of multi-pass (waves reflected by buildings and other land features), and the reference line length (distance from the measurement point to the reference point) and so on have a big impact on measurement precision. The trial measurement achieved high precision thanks to good overhead visibility and freedom from the impact of multi-pass, because GPS sensors were installed near the crest of the dam at the center of the dam body. But it is predicted that at both ends and near the bottom of the dam body, worsening of the overhead visibility of the sensors by the dam body slope and the surrounding mountains, the impact of the multi-pass from the dam body surface, and lengthening of the reference line

will occur, lowering measurement precision. In the future, it will be necessary to confirm the measurement precision under stricter installation conditions.

- (5) Many automatic measurement instruments in addition to GPS malfunction or fail to measure under the effects of power failures or the breakage of NTT telephone circuits caused by lightning, earthquakes, or typhoons. In the future, GPS measurement systems should be equipped with lightning protection measures or independent power supply methods and communication methods.

CONCLUSIONS

This research was a study of the applicability to the measurement of exterior deformation, that is a measurement item that is important for embankment dam safety management, of GPS measurement that can perform surveys quickly and relatively cheaply in order to resolve problems with the conventional geodimeter and leveling surveys: the time and cost such surveys require, and the resulting problem of the frequency of measurements by these methods.

Specifically, the exterior deformation of an existing embankment dam with a central earth core and with dam height of 66.5m was measured by a GPS measurement system and by the conventional geodimeter and leveling surveys. Both results were compared and studied, confirming that the GPS measurement system used for this research can measure exterior deformation of embankment dams in nearly real time with precision that is equal to or superior to conventional methods.

Conventional methods of measuring exterior deformation of embankment dams require that an extremely large number of measurement use targets be installed. If a further study of future GPS measurement systems resolves problems of precision and economic challenges, the embankment dam exterior deformation measurement methods will be changed by completely replacing the geodimeter or leveling surveys with GPS measurements or by making GPS measurement the principal method with the geodimeter or leveling surveys as the supplementary method.

But, for the time being, at locations such as the crest of the highest section of the dam body where the greatest deformation occurs, or where it is assumed that great plastic deformation would occur during a large earthquake (Yamaguchi and Sato, 2003), GPS sensors will be installed along with conventional survey use targets, and at normal times, the precision of GPS sensors will be reconfirmed, while GPS will be applied to perform rapid measurements during emergencies.

REFERENCES

- Committee on Dam Management Workshop. *Practice of Dam Management*. Water Resources Environment Technology Center. Japan (1999). 215-243. (in Japanese)
- Development Department, River Bureau, Ministry of Construction, Japanese Government. *Notices on First Filling of Dam Reservoirs (draft)*. Japan (1999). (in Japanese)
- Iwasaki, T., Oikawa, N. and Shimizu, N. New GPS Monitoring System for Slope Measurement (2) - Improvement of Measurement Accuracy by Trend Model-. *Proc. 41st Technological Research Symposium of Japan Landslide Society*. Japan (2002). 193-196. (in Japanese)
- Iwasaki, T., Takechi, K., Takeishi, A. and Shimizu, N. Development of Measurement Evaluation System for Maintenance and Management of Road Slope. *Soils and Foundations*. Vol.50 . No.6. Japan (2002). 25-27. (in Japanese)

Japan Institute of Construction Engineering. *The Cabinet Order Concerning Structural Standards for River Management Facilities*. Japan (2000). 95-97. (in Japanese)

Matsuda, H., Adachi, H., Nishimura, Y. and Shimizu, N. Examination of Smoothing Process Method and Displacement Forecast of Slope Measurement by GPS. *Journals of the Japan Society of Civil Engineers*. No.715/III-60. Japan (2002). 333-343. (in Japanese with English summary)

Oodera, M., Yoshida, Y., Uchida, J., O-nishi. K. and Iwasaki, T. Examination of Practical Use of Movement Observation by GPS. *Proc. Technological Research Symposium of Shikoku Chapter, The Japanese Geotechnical Society*. Japan (2002). 47-48. (in Japanese)

Suzuki, G. *Introduction to Statistical Analysis by Information Criterion*. Japan (2001). 77-79. (in Japanese)

Yamaguchi, Y. and Sato, H. Subsidence Estimation of Rockfill Dam due to Large-scale Earthquake by Newmark Method. *Proc. 58th Annual Meeting, Japan Society of Civil Engineers*. Japan (2003). III-108 (CD-ROM). (in Japanese)

¹ Principal Researcher, Hydraulic Engineering Research Group, Public Works Research Institute, Japan

² Researcher, Hydraulic Engineering Research Group, Public Works Research Institute, Japan

³ Collaborating Researcher, Hydraulic Engineering Research Group, Public Works Research Institute, Japan

⁴ Director, North Dam Construction Office, Okinawa General Bureau, Cabinet Office, Government of Japan

⁵ Manager, Shamen-net Department, KOKUSAI KOGYO CO., LTD.