

A Competitive Market Integration Model for Distributed Generation

Guillermo A. Jiménez-Estévez, *Student Member, IEEE*, Rodrigo Palma-Behnke, *Senior Member, IEEE*,
Rigoberto Torres-Avila, *Student Member, IEEE*, and Luis S. Vargas, *Senior Member, IEEE*

Abstract—High penetration of distributed generation (DG) resources is increasingly observed worldwide. The evolution of this process in each country highly depends on the cost of traditional technologies, market design, and promotion programs and subsidies. Nevertheless, as this trend accelerates, higher levels of penetration will be achieved and, in turn, a competitive market integration of DG will be needed for an adequate development of the power sector. This paper proposes a competitive market integration mechanism for DG in a pool-based system. The mechanism encompasses both energy and capacity payment procedures in the wholesale market with DG units located at the distribution level. The proposed model is validated for the current Chilean regulation framework and extended to more general market structures. The model can be considered a novel development on the design of competitive markets for DG resources, which are still dominated by subsidies/compensation schemes.

Index Terms—Capacity payments, distributed generation (DG), energy, market design, pool market.

I. INTRODUCTION

DISTRIBUTED GENERATION (DG) can be defined as the integrated use of small generation units directly connected to a distribution system or inside the facilities of a customer [1]. There is growing participation of these technologies in the distribution and subtransmission systems, increasing their contribution to the energy mix of power systems. It is expected that the DG share of worldwide annual capacity additions would be 40% by 2008 [2]. The installed wind power capacity in 2005 reached 59.1 GW at the global level, with 18.4 GW in Germany, 10 GW in Spain, and 9.1 GW in the USA [3].

The evolution of this process in each country highly depends on the cost of traditional technologies (diesel engines, coal fired, combined cycle, hydraulic, and nuclear power plants) and market design concepts (pool, power exchange or physical bilateral-based systems). A key aspect explaining this fast evolution is the development of promotion programs, subsidies, and compensation mechanisms. The driving forces behind these initiatives are the improvement of power supply reliability, environmental concerns, and options for new technology development industries focused on renewable energy [4]–[6].

Manuscript received December 14, 2006; revised July 27, 2007. This work was supported in part by the Fondecyt Grant 1050346, Facultad de Ciencias Físicas y Matemáticas of Universidad de Chile, and in part by the Millennium Institute of Complex Engineering Systems. Paper no. TPWRS-00880-2006.

The authors are with the Department of Electrical Engineering, Universidad de Chile, 8370451 Santiago, Chile (e-mail: gjimenez@ing.uchile.cl).

Color versions of one or more of the figures in this paper are available online at <http://ieeexplore.ieee.org>.

Digital Object Identifier 10.1109/TPWRS.2007.908387

Fig. 1 illustrates a general competitive electricity market framework. Power producers (PP), traders (Td), and free customers (C) are agents of the wholesale market, which can be arranged in a bilateral or a pool-based scheme [7]. The wholesale market involves power and energy exchanges at the transmission level with competitive nonregulated prices. On the other hand, at the distribution level, there are several regional retail markets. Traders are able to offer energy contracts to final retail customers (RC) [8]. In both wholesale and retail markets, costs related to network infrastructure and operation are regulated via transmission and distribution pricing schemes. In the case of distribution systems, point purchase tariffs are used, which are based on average prices or postage stamp procedures [9].

In this scenario, there is a challenge related to an adequate market integration of DG units operating at the distribution level (see Fig. 1). One of the integration mechanisms is a compensation scheme, such as those implemented in Spain [13] and Germany [10], where, for each technology based on renewable resources, fixed prices are defined every two years. The prices for energy, paid by the final customers, are decoupled from market prices. It is important to note that these regulations are compatible, under the subsidiarity principle [11], with the enhanced competitive market framework at the European level [12]–[14]. In the case of California, special promotion programs for DG based on renewable energy, which defines minimum percentages of energy production based on these technologies, are incorporated [15]. In Australia, large purchasers of electricity are directly responsible for supporting electricity generated from renewable energy sources. The mechanism in this case is implemented through the surrender of renewable energy certificates (RECs) in proportion to the acquisitions of electricity. Each REC represents one megawatt hour (MWh) of eligible renewable electricity [16].

In all those cases, DG based on renewable energy is organized as a *parallel market*. This situation can be understood as a transition period in a competitive market evolution, while the DG technologies achieve enough maturity to compete in the conventional wholesale market.

Nevertheless, in most systems, there are no specific definitions or regulations for market integration of DG technologies. This is the current situation in most Latin American countries [17], where no *parallel markets* are in place. Therefore, DG is not able to participate in the wholesale market and, consequently, its integration is limited to bilateral agreements with the distribution company (DisCo). In other cases, the DisCo itself develops the existing DG projects following price signals from the wholesale market. Also, final customers react to peak

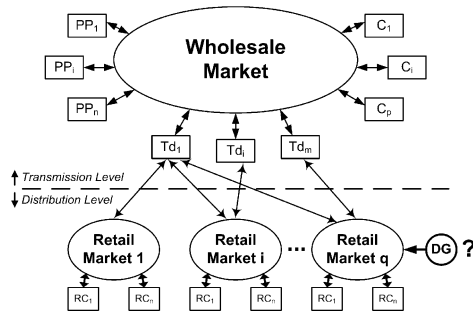

Fig. 1. Competitive electricity market framework.

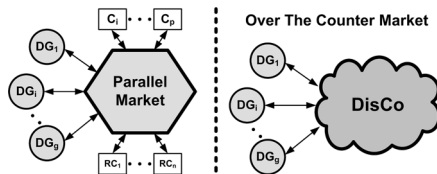

Fig. 2. DG traditional integration schemes.

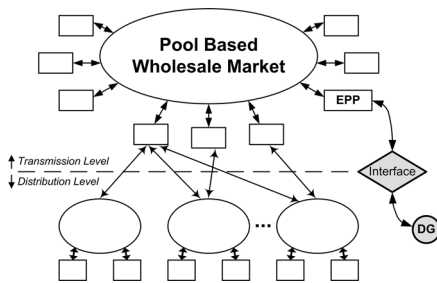

Fig. 3. DG market integration proposal.

load prices by developing peak shaving units. The overall result of these practices is an *over-the-counter* (OTC) market for DG, with no formal structure. A summary of the previously described integration approaches is shown in Fig. 2.

Nowadays, OTC markets (right hand side of Fig. 2) are relatively small in comparison with the energy trade in the wholesale market. Therefore, price signals in the conventional wholesale market are not disturbed significantly by DG agents. However, OTC market structures face difficulties in the case of high penetration of DG, where in fact, for one product (energy), two or three markets may emerge, which may distort price signals for operation and investment. As a result, there is a need in the midterm for a consistent integration of DG in the wholesale market. A similar situation may occur in the case of parallel markets if their share increases significantly in wholesale markets.

In this paper, a novel competitive market integration scheme of DG is proposed. Based on the general framework presented in Fig. 1, this paper develops a market *interface* for DG units to formalize their participation in the wholesale market as an *equivalent power producer* (EPP). An integration scheme, through an interface, is proposed on a pool-based system, as shown in Fig. 3.

The interface involves a set of rules and regulatory procedures for energy and capacity payments in the wholesale market for DG units located at the distribution level.

This paper is organized as follows. In Section II, the Chilean experience is briefly reported and analyzed. Section III presents the proposal of a competitive, pool-based, market integration mechanism for DGs located at the distribution level. Section IV presents an example showing the calculation procedure for the penalty factors at distribution level. In Section V, an illustrative example to analyze the proposed DG insertion scheme on the wholesale market is presented. Finally, in Section VI, conclusions, extensions to other markets, and future work are outlined.

II. CHILEAN EXPERIENCE

The Chilean power market design is based on a mandatory pool with audited costs and financial bilateral contracts. The wholesale spot market is opened only to generators who exchange energy at hourly spot prices and annual capacity at a power price. Those exchanges are based on the calculation of a balance for each supplier, which comprises supplier deliveries and injections. Based on the peak load pricing theory, power (capacity) of a generator has been recognized as a commodity paid by the users [18]. This capacity represents the generator contribution to the system's adequacy.

The distribution sector is a regulated monopoly with a fixed charge scheme. These charges are the service and network average costs, which are estimated from an efficient company model [9]. DisCos purchase energy from the PP at the primary distribution substations (DisCo network boundary) at a regulated *nodal price*. The nodal price represents an estimation of the long-term marginal costs. This calculation considers both the average price of the contracts among free customers and generators, and the expected system's marginal costs for the next four years [19].

On the other hand, during peak load hours of the winter season (May–September), a *power charge* penalty is applied to the customers when they exceed a demand threshold. As a consequence, the use of small generation units for peak shaving has increased during the last few years, developing another form of an OTC market for DG (see Section I). This phenomenon can be observed in Fig. 4, where the maximum system demand during peak hours shows a decrease during the winter season. From Fig. 4, a total of 500 MW are estimated for OTC energy produced out of DG in the central interconnected system (CIS). Alternatively, a direct participation of DG in the wholesale market was historically limited because of its dependency on bilateral agreements with the local DisCo. Usually, DisCo offers purchase prices that do not recognize the DG contribution on adequacy, power quality, and cost reduction. A third element fostering OTC markets for DG comes from the fact that Chile faces energy supply security issues. There is a lack of natural gas supply and a delay of investment in conventional power plants.

In this scenario, the Chilean government introduced changes in the regulatory framework to promote market integration of DG technologies [20]. Relevant changes for DG units are the reduction of transmission charges for renewable energy-based technologies, open access at the distribution level (especially for DG under 9 MW of installed capacity), change in overall capacity payment scheme, and the right of participation in the wholesale market [20].

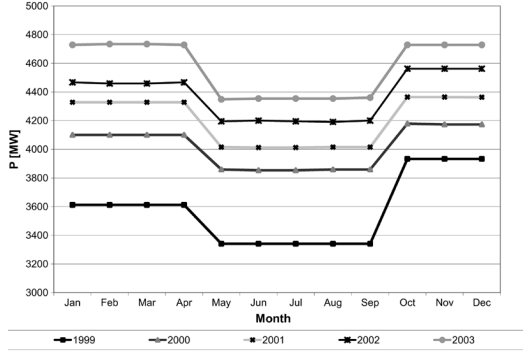

Fig. 4. Variation in peak power demand at the central interconnected system (CIS) since 1999.

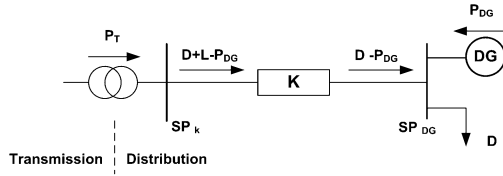

Fig. 5. Simplified model to estimate the spot price at the DG busbar.

In market structures such as the Chilean pool, which is compatible with more general pool design markets, the following key aspects are identified: energy and capacity payments, transmission charges, DG's connection standards, self-dispatch, and energy price stabilization mechanisms.

III. PROPOSED MARKET INTEGRATION MODEL

To design a proper market integration model for DG, it is necessary to consider its participation in the energy and capacity exchanges among the PPs as an EPP in the wholesale market. In the following sections, based on a general description of each exchange mechanism, a detailed description of the DG market interface is presented.

A. Energy Market

A mechanism to establish an energy price for the DG injection could be based on an extended model incorporating the DisCo network into the spot price computation. In this approach, by using an economic dispatch model with network constraints, a spot price at the distribution level (SP_{DG}) can be calculated for the specific injection point of the DG. Nevertheless, the implementation of such a methodology is not practical, mainly because of the size of the network and the difficulties in accessing the necessary data set from the DisCos.

In this paper, a methodology to overcome these difficulties is proposed, which is based on approximations of the system modeling.

The computation of a SP_{DG} implies the incorporation of a new delivery and injection point into the wholesale market. Consequently, the DG sells energy at SP_{DG} , while the DisCo supplier buys the same amount of energy at the same price.

To develop a methodology for estimating SP_{DG} , a simplified network scheme with a DG injecting power at the distribution level is used, as shown in Fig. 5.

In Fig. 5, the DisCo purchases energy from the wholesale system (P_T) and from the DG (P_{DG}). Without the proposed methodology, this second purchase is done via an OTC market, where the DisCo buys energy from DG under a bilateral agreement. Thus, as illustrated in Fig. 5, the energy supply cost (EC) of the DisCo is given by two terms, as follows:

$$EC = P_T \cdot SP_k + EC_{DG} \quad (1)$$

where

P_T active power injection from the transmission system;

SP_k spot price of the wholesale market;

EC_{DG} is the OTC payment from DisCo to DG.

The proposed methodology formalizes the payment EC_{DG} by incorporating the injection point of the DG as an energy exchange point in the wholesale market. The exchange point is the core of the interface mechanism, where the price for the DG energy is computed based on an estimation of the spot price at the injection point of the DG (SP_{DG}). The calculation of SP_{DG} is achieved by using a penalty factor pf_{DG} , which accounts for the effect of DG energy injections on the DisCo network ohmic losses. Consequently, under this interface concept, the energy cost for supplying the DisCo is given by

$$\begin{aligned} EC &= P_T \cdot SP_k + P_{DG} \cdot SP_{DG} \\ EC &= (D + L) \cdot SP_k + P_{DG} \cdot SP_k (pf_{DG} - 1) \end{aligned} \quad (2)$$

where

D total net active power demand in the DisCo;

L total ohmic losses in the DisCo network;

P_{DG} active power generated by the DG units inside the DisCo.

Under the interface concept, the DG busbar is directly incorporated into the wholesale market. This approach allows the formal integration of DG into the wholesale market. Also, when the interface is compared with the traditional OTC-based market, DG injections and the penalty factor (pf_{DG}) are the only additional information required.

The proposed interface concept can be extended to any distribution system with multiple DG injections and multiple busbars connected to the transmission system. In this general case, the energy balance in the DisCo system can be calculated from

$$\sum_{i=1}^{N_T} P_T^i + \sum_{k=1}^{N_{DG}} P_{DG}^k = P_T + P_{DG} = D + L \quad (3)$$

where

N_T total number of energy delivery points of the distribution system from the transmission system;

N_{DG} total number of DGs in the distribution system.

The DisCo losses, L , can be estimated with the following expression [21]:

$$L = K \cdot \left(D - \sum_{k=1}^{N_{DG}} P_{DG}^k \right)^2 = K \cdot (D - P_{DG})^2. \quad (4)$$

The K factor used in (4) (see Fig. 5) approximates an equivalent resistance of the distribution network at medium voltage level. This factor can be estimated using the average values ($\bar{L}, \bar{D}, \bar{P}_{DG}$) of the involved variables at the same voltage level, based on measurements or validated information used in tariff processes. Consequently, a set of different K factors should be used, considering diverse load and supply conditions. Thus, a specific K factor can be calculated as

$$K \approx \frac{\bar{L}}{(\bar{D} - \bar{P}_{DG})^2}. \quad (5)$$

From a practical point of view, in the case of the Chilean system, the lack of certified measurements and public billing data make the use of a set of K factors difficult. In contrast to this situation, annual average ohmic loss calculations are part of approved tariff studies at distribution level, which is a regulated sector in the country. These tariff studies and their cost components are consistent with the postage stamp payment scheme at the distribution level. Nevertheless, the use of a single K factor for the whole period must be consistent with the real marginal cost behavior at distribution level busbars. This aspect is discussed in more detail in Section IV.

The estimation of the SP at the DG busbar, for a specific selected K factor, involves the construction of the penalty factor (pf_{DG}) as follows: replacing (4) in (3), yields

$$P_T + P_{DG} = D + K \cdot (D - P_{DG})^2. \quad (6)$$

P_T and P_{DG} are known values, measured and registered by the market/system operator, for example, in hourly steps. From (6) and (4), L can be calculated as a function of P_T, P_{DG} , and K . This can be achieved by solving the quadratic equation for the auxiliary variable $x = D - P_{DG}$ in (6) and replacing the result in (4). Using (7), the associated penalty factor pf_{DG} [22] is calculated as shown in (8)

$$L = \frac{1}{2 \cdot K} (1 + 2 \cdot K \cdot P_T - \sqrt{1 + 4 \cdot K \cdot P_T}) \quad (7)$$

$$pf_{DG} = \frac{1}{1 - \frac{\partial L}{\partial P_T}} = \sqrt{1 + 4 \cdot K \cdot P_T}. \quad (8)$$

The resulting pf_{DG} for each period can be used to calculate the SP_{DG} using the SP_k defined at the wholesale level. Therefore, for a specific DG_i , the spot price at the injection point SP_{DG_i} is

$$SP_{DG_i} = SP_k \cdot pf_{DG}. \quad (9)$$

The proposed market integration interface behaves in accordance with a marginal cost pricing scheme, representing a compromise between accuracy and operability in a real system. From (8), it can be observed that, in the normal case where $P_T > 0$, SP_{DG_i} is greater than SP_k , reflecting the effect of DG injection on the system ohmic loss reduction. On the other hand, for the counterflow ($P_T < 0$), as expected, $SP_{DG_i} < SP_k$.

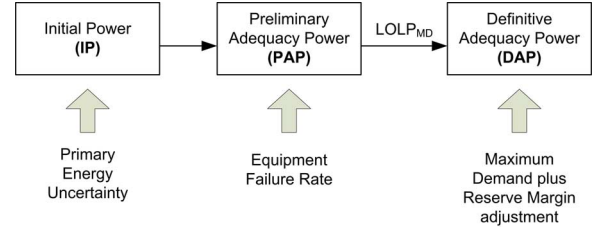

Fig. 6. Procedure for power recognition.

Moreover, the calculated DG spot prices imply price signals for optimum operation at both system and local levels.

B. Capacity Payments

In pool-based markets, a wide range of different schemes for capacity payment (CP) was developed [23]. The recognition of a CP for a DG must be consistent with the CP procedure applied to conventional generation units. Therefore, the proposed scheme is based on a specific CP approach consistent with current proposals under discussion in the Chilean pool system based on peak load pricing [24]. It is important to state that the Chilean CIS can be classified as a hydrothermal system that shows a high hydroelectrical power regulation capability because of the existence of large reservoirs with interannual regulation. Thus, for the Chilean system, adequacy is more conditioned by energy than by power availability under peak load conditions. In Fig. 6, the general framework for capacity recognition and payment is shown.

The capacity recognition of a generation unit, valued at the power price (investment cost of a peak load unit), corresponds to the contribution to the system adequacy of each generation unit in three main steps. In the first step, an initial power (IP) is determined based on the primary energy uncertainty associated with a generation technology. This uncertainty is modeled using a risk analysis approach that evaluates the energy/power contribution of the unit for an adverse scenario. For example, for a run of river plant, its IP is calculated as the expected power injection for a dry year. In the second step, the IP is penalized by considering the equipment failure rate and its effects on the system operation under peak load conditions. The resulting preliminary adequacy power (PAP) corresponds to the expected power injection of each unit for different operation conditions. PAP will be close to IP for units with low failure rate; otherwise, PAP will be lower than IP. In the last step, the definitive adequacy power (DAP) of a unit is determined by the adjustment of the total system PAP with the system peak load, including a reserve margin defined by the regulator. In the following points, specific implementation aspects for DG are briefly discussed.

1) *Initial Power Calculation:* The DG IP does not differ from its installed capacity for power plants with full availability of primary energy. However, this is not the case of DG based on renewable resources such as wind, sun radiation, and water. As mentioned before, for DG units operating in a system with high hydro regulation capability, the uncertainty of primary energy is modeled in the same way as conventional plants, such as run of river hydro units. Thus, IP is determined as the average power injection, considering the historical scarcity of the associated natural resource. For instance, a wind plant IP calculation is

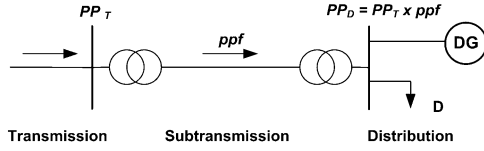

Fig. 7. Power price formulation to DG located in distribution networks.

performed as the average power produced for the year with the lowest wind energy availability (based on wind statistical data) at the wind turbine location.

In the case of historical statistics lacking for a new DG project, a reference data set should be considered. This set can be constructed on the basis of existing data sources such as measurements used for the design of the project or neighbor located projects.

2) *Preliminary Adequacy Power Calculation*: The calculation of a DG PAP requires an estimation of the generation equipment failure rate, which could be obtained using the following criteria.

- The forced outage rate (FOR) is calculated by the ISO every 2 years in accordance with the DG operational statistics. [25].
- International statistics or failure rates guaranteed by the equipment manufacturer are used when the operational information is not available.
- In the case of DG arrays connected to the grid through one connection point, an equivalent state distribution model based on each individual FOR must be calculated.

With the resulting state distribution, a reliability calculation for the whole system, under peak load conditions, is carried out. As a result, the power contributions (PAP) of each unit are calculated [25], [26].

3) *Applicable Power Price*: The power price applicable to a specific DG depends on its location in the system. For each busbar located at the transmission level, a power price PP_T is calculated by the ISO, considering the ohmic losses under peak load conditions.

Power prices for the distribution level busbars PP_D , where DG units are connected usually, must be calculated using power penalty factors ppf applied to the power price of the nearest transmission level busbar. The penalty factor has an analogous treatment as the energy price scheme described in Section III-A. Thus, power contributions at the local level are more valuable than remote contributions from a generator at the transmission level. This procedure is illustrated in Fig. 7.

C. Energy Price Stabilization Mechanism

To promote the entry of a new generation of investors into the market, it is necessary to reduce the risk perception of the projects. Usually, financial entities evaluate this kind of project as a high-risk venture. To deal with this issue, the proposed market integration model incorporates an energy price stabilization mechanism. This mechanism reduces the volatility of the energy spot prices applicable to the DG injection point, improving its credit access.

The proposed energy price stabilization mechanism is formulated as a time-based average of the locational SP over a fixed

time frame. To avoid introducing a new type of price in the market, in the Chilean case, the stabilized price should be identical to the one used to charge distribution customers subject to price regulation. This average price is known as the *energy nodal price* (see Section II).

The creation of a price stabilization mechanism allows the free selection between two energy valuation regimes. However, despite the selected regime, in the long term, the average price recognized to a DG converges to the local energy average spot price.

The stabilization mechanism introduces some problems such as temporal deviations in the generator's market energy balances. In addition, a policy of free swapping between price regimes (stabilized or spot) is prone to misuse, such as making rents over information updates or temporal price differences. To prevent these problems or to limit their impact, some rules can be introduced.

- 1) The ISO must be informed of a regime change 12 months in advance.
- 2) Four years is the minimum period of permanence in each regime (stabilized or spot price).
- 3) Participation in the price stabilization regime is voluntary but only applicable to small DG projects. In the Chilean case, small DGs are those with installed capacity under 9 MW.

IV. PENALTY FACTOR CALCULATION

Fig. 8 shows a 33-busbar distribution system with two DG units. This test system is modeled to understand the calculation procedure of pf_{DG} and to show, for a specific case, the technical consistency of the proposed energy market interface described in Section III-A. Specifically, this test case shows whether the use of a single K factor for the whole period is consistent with the real marginal cost behavior at distribution level busbars, i.e., whether pf_{DG} and SP_{DG} obtained from the approximate proposed model and from an accurate simulation model are close enough. For the accurate model, the term $\partial L / \partial P_T$ from (8) is estimated by multiple AC load flow simulations where system losses are calculated under different DG generation and load scenarios.

The box inside Fig. 8 shows the input data associated with nine operation conditions. These scenarios are obtained from the combination of three DisCo load levels (maximum, medium, and minimum) and three different injection conditions for the DG units (1000, 450, and 100 kW for each unit). A plant factor of 0.45 is considered for each DG unit, and the network parameters concerning the distribution system are taken from literature [27].

Applying the data in Table I and Fig. 8 to (5), the resulting K is

$$K \approx \frac{\bar{L}}{(\bar{D} - \bar{P}_{DG})^2} = \frac{51.5}{(2850 - 900.6)^2} = 1.35 \times 10^{-5}.$$

Applying (8) for each operation condition, the penalty factor (pf_{DG}) is calculated for the whole DisCo. These results are shown in Table I (column 6). The weighted mean value for

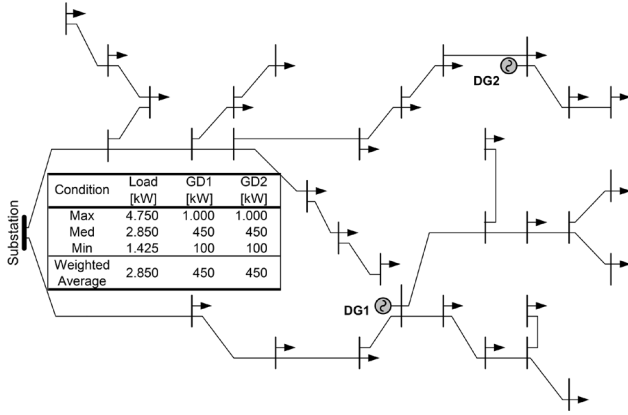

Fig. 8. The 33 busbar distribution system.

TABLE I
PENALTY FACTOR CALCULATION

Scenario gen-load	Duration factor	Local pf_{DG1}	Local pf_{DG2}	DisCo losses [kW]	Aprox. model pf_{DG}	$pf_{DG}-pf$ [%]
Max-max	0.75%	1.016	1.037	79.80	1.074	4.74%
Med-max	9.00%	1.083	1.079	133.60	1.103	2.18%
Min-max	5.25%	1.126	1.102	195.45	1.121	0.70%
Max-med	16.25%	0.988	1.008	25.37	1.023	2.57%
Med-med	29.25%	1.027	1.031	34.27	1.052	2.34%
Min-med	19.50%	1.069	1.057	62.68	1.071	0.84%
Max-min	3.00%	0.968	0.987	25.19	0.985	0.75%
Med-min	10.40%	0.998	1.006	6.03	1.014	1.25%
Min-min	6.60%	1.027	1.024	12.77	1.033	0.79%
Weighted Mean Value		1.034	1.036	51.5	1.052	1.74%

pf_{DG} is 1.052. Table I summarizes the main results obtained for the test case.

Columns 1 and 2 describe the simulated scenario and the associated time duration factor. Using the accurate model (columns 3 and 4), the penalty factors for each DG (pf_{DG1} , pf_{DG2}) are calculated for each scenario. Column 5 shows the ohmic losses of the DisCo for each simulation. Finally, in the last column, the difference between the approximate proposed model and the accurate simulation model is presented. A first conclusion for this case is that the proposed model shows an average difference of 1.74% in comparison with the accurate approach. Despite the errors of the proposed model, the obtained penalty factors, pf_{DG} , are closer to pf_{DG1} and pf_{DG2} than a nonrecognition alternative, represented by a penalty factor of 1.

It is also important to note that, in this case, the proposed model is frequently above the accurate model. Nonetheless, from a theoretical point of view, this result is not valid for all cases. The accuracy in the use of one K factor depends on both the relative location of the DG units and the load distribution in the system. In this context, for a real system, with available high-quality measurements, the K factor calculated in (10) can be adjusted to represent the relative impact of the DG injections on DisCo losses. Alternatively, the DisCo network can be subdivided into more than one subnetwork with different K factors.

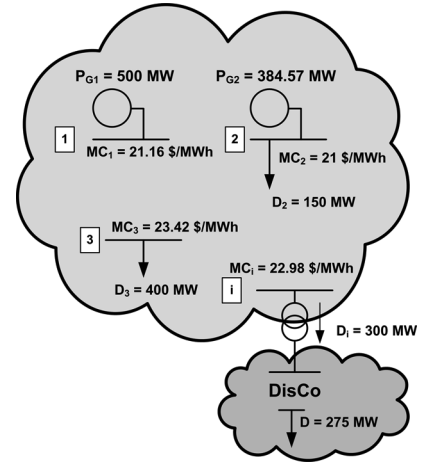

Fig. 9. Illustrative example, case without DG.

V. APPLICATION EXAMPLE

In this section, an illustrative example to analyze the DG insertion scheme on the wholesale market is presented. In Fig. 9, a small interconnected power system containing two generators (in busbars 1 and 2), two generic loads (in busbars 2 and 3), and a DisCo connected to busbar i is presented. The system load is 850 MW and the marginal generator is generator 2 located at busbar 2.

In this system, the following bilateral contracts are in place.

- Generator 1 supplies demand D_3 .
- Generator 2 supplies demand D_2 .
- Generator 2 supplies demand D_1 .

The energy balance at the wholesale market level for each generator is equal to the generator sales minus the load purchases. The energy sale price corresponds to the spot price at the injection points. On the other hand, the purchases are realized at spot price at the delivery points. In formal terms

$$EBG_k = ES_k - \sum_{j \in k} EP_{kj} \quad (10)$$

where EBG_k is the energy balance for generator k , ES_k are the sales of generator k at its injection point, and EP_{kj} is the energy purchase of generator k at the delivery point j .

Additionally, the system marginal income (MI) is defined as the difference between the total sales and total purchases in the system. It is obtained by applying a spot price-based payment scheme in the wholesale market [7], [21]. Under noncongestion operation, the MI reflects the existence of ohmic losses in the system.

A. Case Without DG

The case where there is no DG in the DisCo's grid is shown in Fig. 9, where SP_k stands for spot price at busbar k in \$/MWh.

The energy balance for each generator during a period of 1 h is as follows.

Energy balance for generator 1

$$EBG_1 = 500 \cdot 21.16 - 400 \cdot 23.42 = \$1\,212.$$

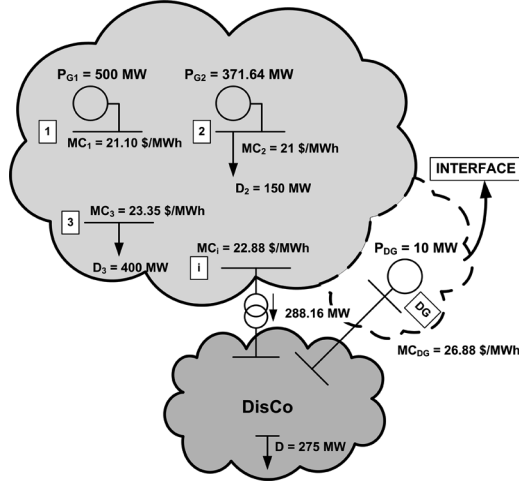

Fig. 10. Case with DG.

Energy balance for generator 2

$$EBG_2 = 384.57 \cdot 21 - 150 \cdot 21 - 300 \cdot 22.98 = \$ - 1\,968.$$

Marginal income

$$MI = \$756.$$

Total system losses without considering the DisCo

$$\begin{aligned} \text{Losses} &= 34.57 \text{ MW} \\ & (4.07\% \text{ of system demand at wholesale level}). \end{aligned}$$

B. Case With DG

In this example, the effects of market integration of new DG units with a total capacity of 10 MW inside the DisCo are analyzed. The analysis can be extended directly to more than one DG unit. Thus, the demand D_i is reduced to 288.16 MW, while the net DisCo demand at the distribution level remains at 275 MW (Fig. 10).

In the proposed market interface, the DG and its injection point are considered as part of the wholesale market (expansion with dashed lines in Fig. 10). It is also shown that most busbar spot prices experience changes as compared with those in Fig. 9 (case without DG). Also, G2 varies its dispatch to 371.64 MW, which represents a decrease in generation of 2.93 MW from the wholesale market point of view.

Considering the DisCo as a one-node system with a general loss function, for this scenario, the K factor for the DisCo is calculated as follows [see (5)]

$$\begin{aligned} K &\approx \frac{\bar{L}}{(\bar{D} - \bar{P}_{DG})^2} \\ &\approx \frac{23.16}{(275 - 10)^2} \approx 3.3 \times 10^{-4}. \end{aligned}$$

Once the K factor is estimated, the DG penalty factor is calculated, obtaining $pf_{DG} = 1.175$. Thus, the spot price at the DG injection point, SP_{DG} is

 TABLE II
 ENERGY BALANCE COMPARISON

Agent	Energy balance without DG	Energy balance with DG
G1	1,212	1,210
G2	-1,968	-2,207
DG	---	269
MI	753	729

$$SP_{DG} = SP_i \cdot pf_{DG} = 22.88 \cdot 1.175 = 26.88 \text{ \$/MWh}.$$

With SP_{DG} , it is possible to perform the following new energy balance for all generators.

Energy balance for generator 1

$$EBG_1 = 500 \cdot 21.10 - 400 \cdot 23.35 = \$1\,210.$$

Energy balance for generator 2

$$EBG_2 = 371.64 \cdot 21 - 150 \cdot 21 - 288.16 \cdot 22.88 - 10 \cdot 26.88 = \$ - 2\,207.$$

Energy balance for DG

$$EB_{DG} = 10 \cdot 26.88 = \$269.$$

Marginal income

$$MI = \$729.$$

Total system losses without considering the DisCo

$$\begin{aligned} \text{Losses} &= 33.48 \text{ MW} \\ & (3.99\% \text{ of system demand at wholesale level}). \end{aligned}$$

A comparison between the energy balances before and after the DG incorporation is shown in Table II.

The impacts produced on the different participants are as follows.

- A minimum effect in the balance of generator G1.
- An increase in the negative balance of generator G2. This result is mainly because of the reduction of G2 power sales in the system. In fact, the costs of supplying the DisCo decreased from \$6894.00 to \$6862.90.
- A decrease in the system MI reflecting a reduction in system losses.
- A surplus condition for the DG (without contracts) with its injection of 10 MW valued at spot price.

The resulting impacts highly depend on the network characteristics and the generation costs and portfolio of each market agent. Consequently, the previous simulation of the DG technology integration can help define market strategies.

Based on the simplified assumptions discussed in previous sections, it is important to note that the DG can be easily integrated to the wholesale market. The only required information to perform the DG integration is its injections and the associated penalty factor (pf_{DG}). This makes possible the treatment of the DG as an EPP.

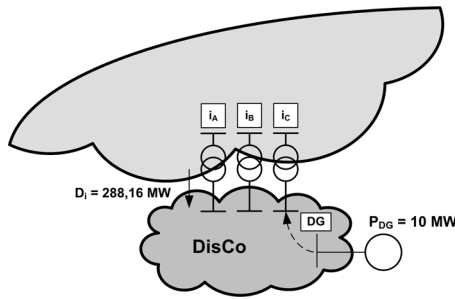

Fig. 11. Multiple supply busbars.

C. Multiple DisCo Feeding Busbars

In most cases, DisCos are supplied through multiple busbars. The proposed methodology makes it necessary to associate the DG to a unique busbar to calculate its corresponding spot price; therefore, it is required that the appropriate busbar is selected to perform the calculation. For instance, in Fig. 11, three different busbars feeding the DisCo example under analysis are shown.

In this example, busbar i has been broken down into three busbars— i_A , i_B , and i_C . As these busbars belong to the transmission system, each one of them has a different spot price; there is a need to find a criterion to select the appropriate busbar for the DG under study. The proposed criterion to identify SP_{ik} for a specific DG is based on the minimal *electrical distance* under normal feeder operation of the DisCo network. It is important to note that the proposed methodology refers each DG_i to a unique SP_k at the wholesale level.

VI. CONCLUSION AND FUTURE WORK

The novel market integration mechanism presented in this paper demonstrates that the design of a market interface and the consideration of DG units as EPP behave in accordance with the wholesale market methodology. The main concepts of the proposal are presented theoretically and are illustrated in two examples. The proposed scheme shows an adequate trade-off between technical accuracy (marginal cost theory and ohmic losses) and practicability (available network information, information management). Nevertheless, for a specific real scenario, the model can be specialized, considering more than one K factor and best representation of the DisCo network.

This implementation is very useful for systems where the DGs operate under an OTC market scheme because it allows the participation of DGs as EPP. This consideration could be associated with an improvement of the competitiveness of the DG projects.

The methodology proposed in this paper is focused on OTC markets embedded in a pool-based wholesale market structure. Nevertheless, based on the previous analysis, its main concepts can be extended to markets based on physical bilateral contracts and power exchanges (PBC/PE), similar to those in North America and Europe. The extension to these markets can be carried out by considering the following criteria.

A) *Energy market*: The calculation of SP_{DG} (presented in Section III-A) is achieved by using a penalty factor pf_{DG} , which accounts for the effect on DisCo network ohmic losses as a result of DG energy injections. In the case of

uni-nodal power exchanges with only one clearing price for the whole system or in the case of nonpublic energy prices of bilateral contracts, the SP_{DG} scheme cannot be applied directly. In this type of structure, the impact on ohmic losses by DG units can be recognized, for example, in the *losses of compensation ancillary services*. The pf_{DG} can be applied to amend either the injection or the service price recognized to the DG, in accordance with the specific mode for purchasing losses in the compensation service [28].

- B) *Capacity payment*: These schemes are often incorporated in PBC/PE market structures. Therefore, an extension for DG capacity recognition can be adapted in specific capacity payment methodology approaches, such as primary energy availability, equipment failure rate, and effect on peak load losses. For markets without capacity payment recognition, prices on peak hours of the *energy market* and the respective loss compensation service should reflect the contribution of the DG units.
- C) *Energy price stabilization mechanism*: In the case of a DG forced to sell all its energy in a power exchange, a price stabilization mechanism can be established, for example, by using guaranty funds of the market agents or a financial contribution of the government.

Future work in this field will be focused on the evaluation of calculation alternatives of penalty factors at the distribution level and the development of specific market interfaces for other market structures.

REFERENCES

- [1] T. Ackermann, G. Andersson, and L. Söder, "Distributed generation: A definition," *Electric Power Syst. Res.*, vol. 57, pp. 195–204, 2001.
- [2] H. B. Püttgen, R. Macgregor, and F. C. Lambert, "Distributed generation: Semantic hype or the dawn of a new era?," *IEEE Power Energy Mag.*, pp. 22–29, Jan./Feb. 2003.
- [3] Global Wind Energy Council, *Global Wind Rep.*, 2005.
- [4] "Distributed generation in liberalised electricity markets," International Energy Agency 2002, OECD/IEA.
- [5] M. V. Engel, "Markets for distributed generation," in *Proc. IEEE Power Eng. Soc. Summer Meeting*, 2000, vol. 1, pp. 52–53.
- [6] T. Ackermann, G. Andersson, and L. Söder, "Electricity market regulations and their impact on distributed generation," presented at the IEEE Int. Conf. Electric Utility Deregulation and Restructuring and Power Technologies, London, U.K., 2000.
- [7] H. Rudnick, R. Varela, and W. Hogan, "Evaluation of alternatives for power system coordination and pooling in a competitive environment," *IEEE Trans. Power Syst.*, vol. 12, no. 2, pp. 605–613, May 1997.
- [8] R. Palma-Behnke, J. L. Cerda, L. Vargas, and A. Jofré, "A distribution company energy acquisition market model with integration of distributed generation and load curtailment options," *IEEE Trans. Power Syst.*, vol. 20, no. 4, pp. 1718–1727, Nov. 2005.
- [9] H. Rudnick and J. A. Donoso, "Integration of price cap and yardstick competition schemes in electrical distribution regulation," *IEEE Trans. Power Syst.*, vol. 15, no. 4, pp. 1428–1433, Nov. 2000.
- [10] I. K. Burges and I. J. Tvele, "Power systems operation with high penetration of renewable energy—The German case," in *Proc. Int. Conf. Future Power Systems*, 2005, pp. 1–5.
- [11] A. Muñoz, R. Palma, G. Jiménez, and G. Castillo, "Fundamentos para la constitución de un mercado común de electricidad," *Ser. Rec. Nat. e Infraestructura* 73. ECLAC, 2003.
- [12] Decision No. 1229/2003/EC: Guidelines for Trans-European Energy Networks and Repealing Decision No. 1254/96/EC Jun. 2003, European Parliament.
- [13] "European Union Directive 2001/77/EC: On the promotion of electricity produced from renewable energy sources in the internal energy market," *Off. J. Eur. Commun.* vol. L283, Oct. 2001.

- [14] K. Palmer and D. Burtraw, "Cost-effectiveness of renewable electricity policies," *Energy Econ.*, vol. 27, pp. 873–894, 2005.
- [15] M. C. Moore and M. H. Masri, "Renewable energy and electricity restructuring: The California model," *IEEE Power Eng. Rev.*, vol. 19, no. 1, pp. 13–14, Jan. 1999.
- [16] "Fact sheet: Mandatory renewable energy target overview," Australian Government, Office of the Renewable Energy Regulator Mar. 2006.
- [17] M. Vignolo, "The influence of market regulations in the development of distributed generation," presented at the 2nd Int. Symp., Stockholm, Sweden, 2002.
- [18] M. Boiteux, "Peak load pricing," *J. Business*, vol. 33, no. 2, pp. 157–179, 1960.
- [19] F. Morandé and R. Raineri, (*De*)*Regulation and Competition: The Electric Industry in Chile*, 1st ed. Santiago, Chile: Ilades, 1997.
- [20] (Regulatory framework) Ley 19.940/2004, Ministerio de Economía Fomento y Reconstrucción Chile, 2004.
- [21] M. Rivier, I. Pérez-Arriaga, and G. J. Luengo, "A model for computation of spot prices in interconnected power systems," presented at the 10th Power Systems Computation Conf., Graz, Austria, Aug. 19–24, 1990.
- [22] B. Wollenberg and A. Wood, *Power Generation, Operation, and Control*, 2nd ed. New York: Wiley, 1996, pp. 114–116.
- [23] G. L. Doorman and I. Wangenstein, "Demand side provision of peaking capacity and reserves in deregulated power systems," presented at the Power Eng. Soc. Winter Meeting, 2000.
- [24] O. Moya, "Experience and new challenges in the Chilean generation and transmission sector," *Energy Policy* 30. Elsevier, 2002.
- [25] (Regulatory framework) Decreto Supremo 62/2006, Reglamento de transferencias de potencia entre empresas generadoras establecidas en la Ley General de Servicios Eléctricos, Ministerio de Economía Fomento y Reconstrucción Chile, 2004.
- [26] (Regulatory framework) Decreto Supremo 327/1997, Reglamento de la Ley General de Servicios Eléctricos, Ministerio de Economía Fomento y Reconstrucción Chile, 2004.
- [27] N. Boulaix and M. Papadopoulos, "Optimal feeder routing in distribution system planning using dynamic programming technique and GIS facilities," *IEEE Trans. Power Del.*, vol. 17, no. 1, pp. 242–247, Jan. 2002.
- [28] W. Haixia, L. Weidong, T. Jiaqi, and G. Debin, "Research on modes of purchasing transmission loss compensation service," presented at the IEEE/PES Transmission and Distribution Conf. Exhibition: Asia and Pacific, Dalian, China, 2005.

Guillermo A. Jiménez-Estévez (S'05) was born in Bogotá, Colombia. He received the B.Sc. degree in electrical engineering from the Escuela Colombiana de Ingeniería, Bogotá, in 1998, and the M.Sc. degree from the Universidad de Chile, Santiago, in 2003. He is currently pursuing the Ph.D. degree at the Universidad de Chile.

His main research interests are distributed generation and distribution systems planning.

Rodrigo Palma-Behnke (SM'04) was born in Antofagasta, Chile. He received the B.Sc. and M.Sc. degrees in electrical engineering from the Pontificia Universidad Católica de Chile and the Dr. Ing. degree from the University of Dortmund, Germany.

He is currently a Professor in the Electrical Engineering Department, University of Chile, Santiago. His research field is the planning and operation of electrical systems in competitive power markets and new technologies.

Rigoberto Torres-Avila (S'06) was born in Chile. He received the B.Sc. degree in electrical engineering and the M.Sc. degree from the Universidad de Chile, Santiago, in 2000 and 2005, respectively, where he is currently pursuing the Ph.D. degree.

His main research interests are economics and the planning of electric power systems.

Luis S. Vargas (SM'06) received the Electrical Engineer Diploma and the M.Sc. degree from the Universidad de Chile, Santiago, in 1985 and 1987, respectively. He received the Ph.D. degree in electrical engineering from the University of Waterloo, Waterloo, ON, Canada.

Since 1994, he has been an Associate Professor at the Universidad de Chile. His main research interests are in the areas of supply and demand forecasting and expansion planning of energy systems.