

Hyoid apparatus and pharynx in the lion (*Panthera leo*), jaguar (*Panthera onca*), tiger (*Panthera tigris*), cheetah (*Acinonyx jubatus*) and domestic cat (*Felis silvestris f. catus*)

G. E. Weissengruber,¹ G. Forstenpointner,¹ G. Peters,² A. Kübber-Heiss³ and W. T. Fitch⁴

¹Institute of Anatomy, and ³Institute of Pathology and Forensic Veterinary Medicine, University of Veterinary Medicine, Vienna, Austria

²Zoologisches Forschungsinstitut und Museum Alexander Koenig, Bonn, Germany

⁴Department of Psychology, Harvard University, Cambridge, MA, USA

Abstract

Structures of the hyoid apparatus, the pharynx and their topographical positions in the lion, tiger, jaguar, cheetah and domestic cat were described in order to determine morphological differences between species or subfamilies of the Felidae. In the lion, tiger and jaguar (species of the subfamily Pantherinae) the *Epihyoideum* is an elastic ligament lying between the lateral pharyngeal muscles and the *Musculus (M.) thyroglossus* rather than a bony element like in the cheetah or the domestic cat. The *M. thyroglossus* was only present in the species of the Pantherinae studied. In the lion and the jaguar the *Thyrohyoideum* and the thyroid cartilage are connected by an elastic ligament, whereas in the tiger there is a synovial articulation. In adult individuals of the lion, tiger and jaguar the ventral end of the tympanohyal cartilage is rotated and therefore the ventral end of the attached *Stylohyoideum* lies caudal to the *Tympanohyoideum* and the cranial base. In newborn jaguars the *Apparatus hyoideus* shows a similar topographical position as in adult cheetahs or domestic cats. In adult Pantherinae, the *Basihyoideum* and the attached larynx occupy a descended position: they are situated near the cranial thoracic aperture, the pharyngeal wall and the soft palate are caudally elongated accordingly. In the Pantherinae examined the caudal end of the soft palate lies dorsal to the glottis. Differences in these morphological features between the subfamilies of the Felidae have an influence on specific structural characters of their vocalizations.

Key words descensus of larynx; Felidae; pharyngeal muscles; topography; upper vocal tract.

Introduction

The tetrapod hyoid apparatus provides the skeletal scaffolding supporting the tongue, upper vocal tract and larynx, and thus forms the core of the vocal production system. Hyoid anatomy in mammals is very consistent in broad overview, with the number and general shape of segments, and the muscles connecting them, being highly conserved in mammalian evolution. Conceptually these segments can be broken into two divisions

(see Fig. 1): the base portion (ceratohyoid, basihyoid and thyrohyoid) which provides a bony support for the tongue rostrally and larynx caudally, and a linkage portion which links the base to the skull (tympanohyoid, stylohyoid and epihyoid). The hyoid apparatus of mammals can vary in the extent to which its constituent parts are ossified, cartilaginous or ligamentous. This variation can occur among different species of the same order (e.g. Rodents, Primates) or family (e.g. Felidae [Carnivora]) and even within the same species such as humans (Fürbringer, 1922; Lykaki & Papadopoulos, 1988; Nakano et al. 1988). The first hint on the peculiarities of the hyoidean apparatus in the carnivoran family Felidae was published by Owen (1835). The main finding in a later survey by Pocock (1916) was that in five cat species (lion, tiger, jaguar, leopard,

Correspondence

Dr Gerald Weissengruber, Institute of Anatomy, University of Veterinary Medicine Vienna, Veterinärplatz 1, 1210 Vienna, Austria.
Tel. + 43 1 25077 2505; fax: + 43 1 25077 2590;
e-mail: gerald.weissengruber@vu-wien.ac.at

Accepted for publication 9 July 2002

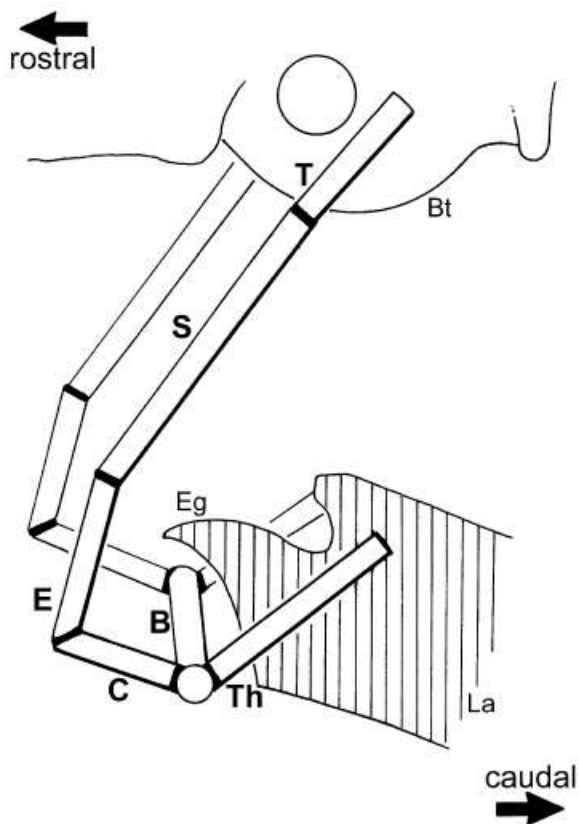

Fig. 1 Schematic drawing of the elements of the hyoidean apparatus (lateral view). T, *Tympanohyoideum*; S, *Stylohyoideum*; E, *Epihyoideum*; C, *Ceratohyoideum*; B, *Basihyoideum*; Th, *Thyrohyoideum*; Bt, *Bulla tympanica*; Eg, epiglottis; La, larynx.

snow leopard) the *Epihyoideum* is an elastic ligament, whereas in all other species of the Felidae the epihyal is completely ossified. Owen (1835) hypothesized that these differences in hyoid structure are correlated with differences in the species' vocal repertoires: those felids with an elastic epihyoid are able to roar but not to purr, while species with a completely ossified hyoid are able to purr but not to roar. Pocock (1916) and many subsequent authors (e.g. Neff, 1982) have verified this observation, which has led to the use of hyoid anatomy playing a role in the classification of these five cat species as 'roaring cats' (Pantherinae).

For many years researchers interested in the evolution of speech have noted that the human vocal tract is unusual in that the larynx is located very low in the throat relative to other mammals, and indeed until recently this position was considered to be uniquely human and to be crucially linked to the evolution of speech. However, recent research has demonstrated a low laryngeal position in red and fallow deer as well

Table 1 Examined specimens

Species	Number	Sex	Age
Lion (<i>Panthera leo</i>)	1	M	1 y
Tiger (<i>Panthera tigris</i>)	3	1M, 2F	adult
Jaguar (<i>Panthera onca</i>)	2	M, F	23 y
Cheetah (<i>Acinonyx jubatus</i>)	2	M, F	1 day
Cheetah (<i>Acinonyx jubatus</i>)	1	M	6 y
Domestic cat (<i>Felis silvestris</i> f. <i>catus</i>)	5	3F, 2M	adult

(Fitch & Reby, 2001). These authors hypothesized that the low laryngeal position in these deer species serves to lengthen the vocal tract, lowering formant frequencies and thus resulting in a more impressive roar. The above cited work on roaring cats suggests that a similar morphological phenomenon may be present in these species.

The main aim of the present paper is to describe accurately the structure and relative topographical position of the hyoid and associated pharyngeal structures in the species of the Felidae at different stages of ontogenetic development and to point out the influence these may have on vocalization.

Materials and methods

The heads and necks of one lion, three tigers, four jaguars, one cheetah and five domestic cats were examined within a few hours after death or after formalin fixation, using radiography, computed tomography (CT), magnetic resonance imaging (MRI) and gross anatomical as well as histological methods (see Table 1). The male tiger was examined by CT only. Dissected specimens were either deep frozen, macerated or fixed in buffered formalin. The taxonomy of the species studied follows Wozencraft (1993). The lion, the female tigers, the adult jaguars and the cheetah had lived in the Vienna Schönbrunn Zoo and the Safaripark Gänserndorf (Austria) and were killed by zoo veterinarians because of severe disorders of the locomotor apparatus or the central nervous system. The male tiger and the domestic cats were kept by private owners either in Austria (domestic cats) or USA (tiger). The jaguar cubs died on their first day of life in a private Austrian zoo. Diagnostic radiological imaging of the lion was performed prior to its death during a routine diagnostic procedure. All histological specimens from all individuals were sectioned and then stained with haematoxylin-eosin, azan, and by Weigert's method. All measurements were performed in formalin-fixed

Table 2 Summary of morphological findings and measurements (in mm)

Structure	Lion	Tiger	Jaguar (adult)	Cheetah	Domestic cat
Tympanohyoid	c	c	c	c	c
Length (dorsoventral)	27	20–21	20–21	16	10
Breadth (rostrocaudal)	4–5	7	4–5	4–5	1–2
Stylohyoid	b	b/c	b	b	b
Length	28	36/9	41–44	32	12
Diameter (Corpus)	1–2	–3.5	1–2	4–5	0.9–1
Epihyoid	l/b	l	l	b	b
Length	110	45	55	22	10
Ceratohyoid	b	b	b	b	b
Length (rostrocaudal)	16	13	M: 16 F: 12	18	5
Basihyoid	b	b	b	b	b
Length (laterolateral)	37	33	30	22	10
Width (rostrocaudal)	8	6	6	3.5	1
Thyrohyoid	b/c	b/c	b/c	b/(c)	b/(c)
Length (bone + cartilage)	40	50	M: 35 F: 30	23	11
Width (rostrocaudal)	10–12	5–7	M: 5–10 F: 3–8	4–7	2–3.5
Length of upper vocal tract (distance between lips and glottis)	380	290	M: 330 F: 310 Newborn: 35	210	80

Abbreviations: c, cartilaginous; b, bony; l, ligamentous; M, male; F, female.

Fig. 2 Hyoid apparatus, larynx and cranial part of the trachea in the lion. G, *M. geniopharyngeus*; To, tongue; T, *Tympanohyoideum*; S, *Stylohyoideum*; E, *Epihyoideum*; C, *Ceratohyoideum*; B, *Basihyoideum*; Th, *Thyrohyoideum*; Ct, *Cartilago thyroidea*; Gt, *Glandula thyroidea* (position indicated by broken line).

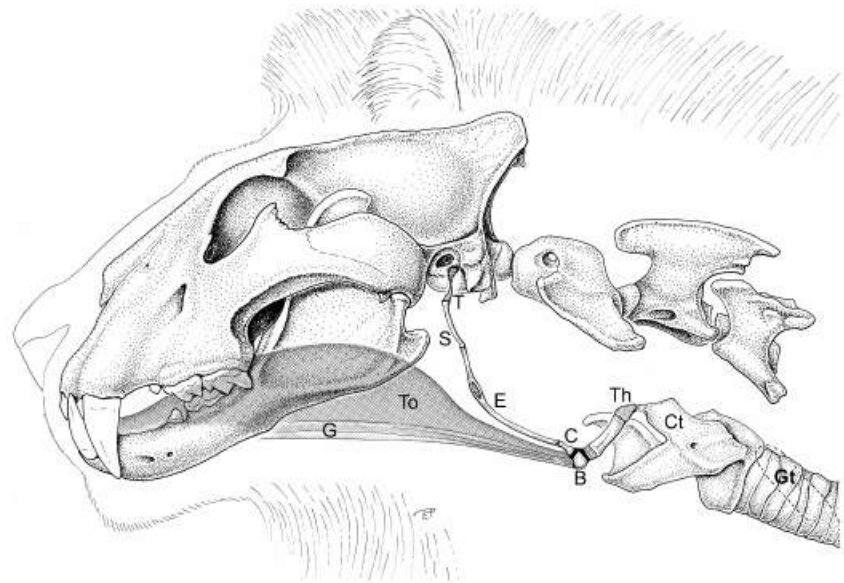

specimens using a caliper (hard tissue) or a measuring tape (soft tissue, length of upper vocal tract). In the jaguar cubs muscles were not examined and length measurements of hyoid structures were not performed.

Results

A comparative overview of the findings concerning hyoid apparatus and upper vocal tract (distance between lips and glottis) is given in Table 2.

Position of the basihyal bone

All examined specimens of hyoid bones in the lion, tiger and adult jaguar display a relatively uniform position relative to the cervical vertebrae. The *Basihyoideum* is situated in the middle or caudal part of the neck on a level with the body of the 3rd to 5th cervical vertebra. In the lion, which was dissected immediately after its death, the basihyal bone is on a level with the 5th cervical vertebra. In our specimens of lion (Fig. 2),

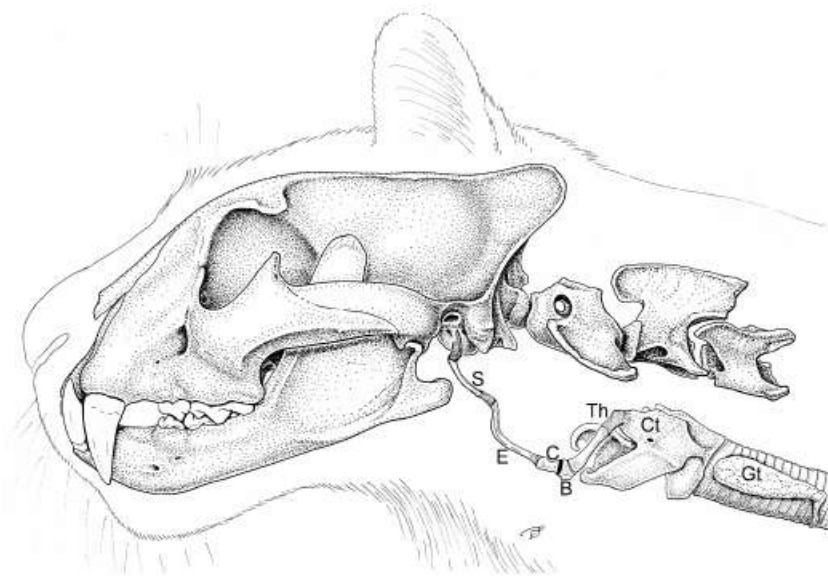

Fig. 3 Hyoid apparatus, larynx and cranial part of the trachea in the tiger. T, *Tympanohyoideum*; S, *Stylohyoideum*; E, *Epihyoideum*; C, *Ceratohyoideum*; B, *Basihyoideum*; Th, *Thyrohyoideum*; Ct, *Cartilago thyroidea*; Gt, *Glandula thyroidea*.

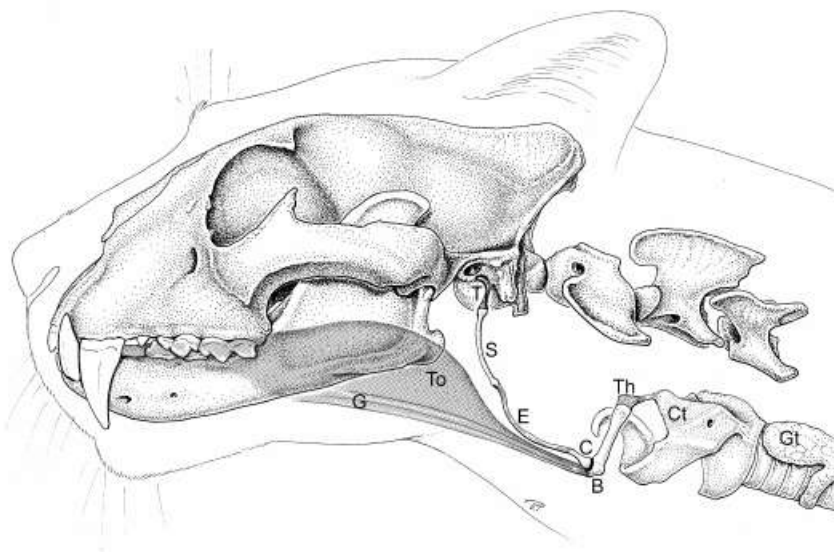

Fig. 4 Hyoid apparatus, larynx and cranial part of the trachea in the jaguar. G, *M. geniohyoideus*; To, tongue; T, *Tympanohyoideum*; S, *Stylohyoideum*; E, *Epihyoideum*; C, *Ceratohyoideum*; B, *Basihyoideum*; Th, *Thyrohyoideum*; Ct, *Cartilago thyroidea*; Gt, *Glandula thyroidea*.

tiger (Fig. 3) and jaguar (Fig. 4) the position is more cranial after formalin-fixation than before, possibly due to retraction of the pharyngeal wall and the *Musculi (Mm.) geniohyoidei* and *hyoglossi*. In the newborn jaguars the basihyal bone lies ventral of the *Bullae tympanicae* (Fig. 5). The *Basihyoideum* of the cheetah (Fig. 6) shows a position similar to that found in domestic cats (Figs 7 and 8), i.e. ventral of the cranial base or the atlas.

***Tympanohyoideum* and associated muscles**

In the 1-year-old lion (Fig. 9), in the cheetah and in the domestic cat the *Tympanohyoideum* is cartilaginous. In

the tiger and the adult jaguar (Fig. 10) it consists of calcified cartilage. On its dorsal border it is syndesmatically attached to the skull caudoventral of the *Porus acusticus externus*. Because this syndesmosis and the small *Musculus (M.) occipitohyoideus* (inserting into the dorsal half of the *Tympanohyoideum* at its caudal border) are its only attachments to the skull, the ventral end of the tympanohyal cartilage can be moved rostrally and caudally. Unlike the situation in the domestic cat and the cheetah the ventral part of the tympanohyal cartilage in the subadult lion, adult jaguar and tiger is rotated caudally about its longitudinal (dorsoventral) axis (see Fig. 9). Therefore, the former rostral border of the ventral part of the

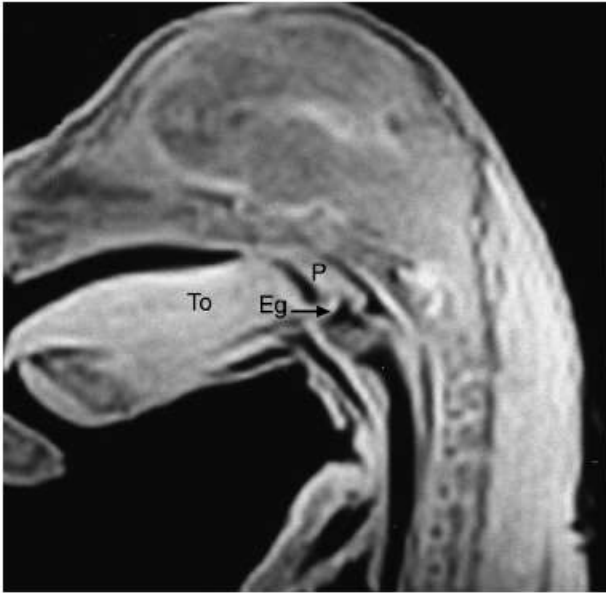

Fig. 5 Magnetic resonance imaging of the head and neck of a newborn jaguar. To, tongue; Eg, epiglottis; P, soft palate.

tympanohyal cartilage lies caudal in these three species. As there is no indication of this rotation in newborn jaguars, it is highly likely to proceed during postnatal development.

The *M. stylohyoideus* originates dorsolateral on the *Tympanohyoideum*, and then runs ventrally (Fig. 11). In the lion, tiger and adult jaguar it attaches to the caudal border of the *M. mylohyoideus* only (Fig. 12) and makes no contact with the basihyoid. In the cheetah and the domestic cat the *M. stylohyoideus* inserts with its major

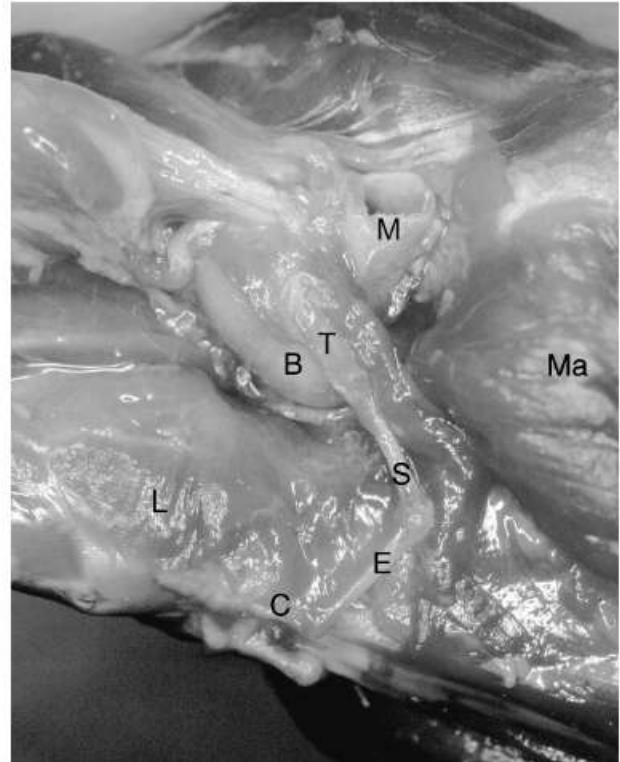

Fig. 7 Upper neck region of the domestic cat after removal of the skin, parotis and *M. digastricus* (lateroventral view, left = caudal). L, larynx; B, *Bulla tympanica*; M, *Meatus acusticus externus*; Ma, *M. masseter*; T, *Tympanohyoideum*; S, *Stylohyoideum*; E, *Epihyoideum*; C, *Ceratohyoideum*.

part on the *Basihyoideum*. In the lion, tiger and adult jaguar the *M. styloglossus* originates on the dorsal part of the *Tympanohyoideum* (Fig. 11). In the adult jaguar this muscle reveals an additional but much smaller

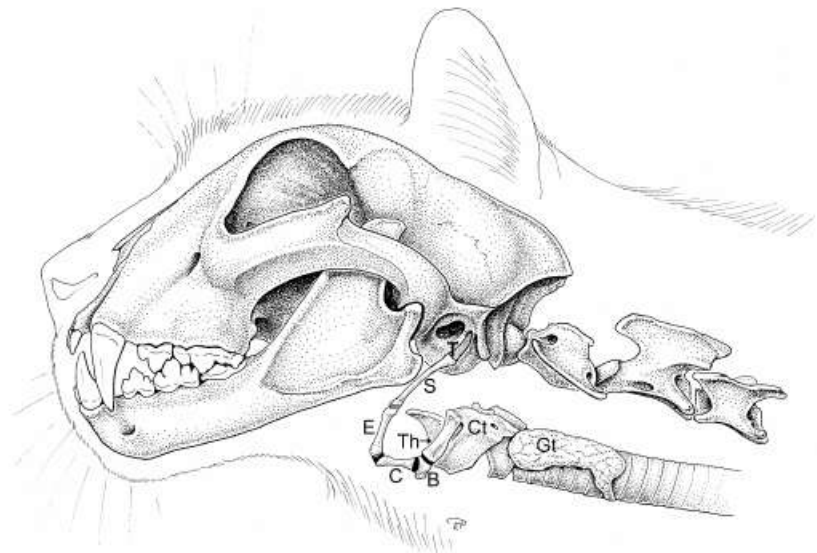

Fig. 6 Hyoid apparatus, larynx, and cranial part of the trachea in the cheetah. T, *Tympanohyoideum*; S, *Stylohyoideum*; E, *Epihyoideum*; C, *Ceratohyoideum*; B, *Basiyoideum*; Th, *Thyrohyoideum*; Ct, *Cartilago thyroidea*; Gt, *Glandula thyroidea*.

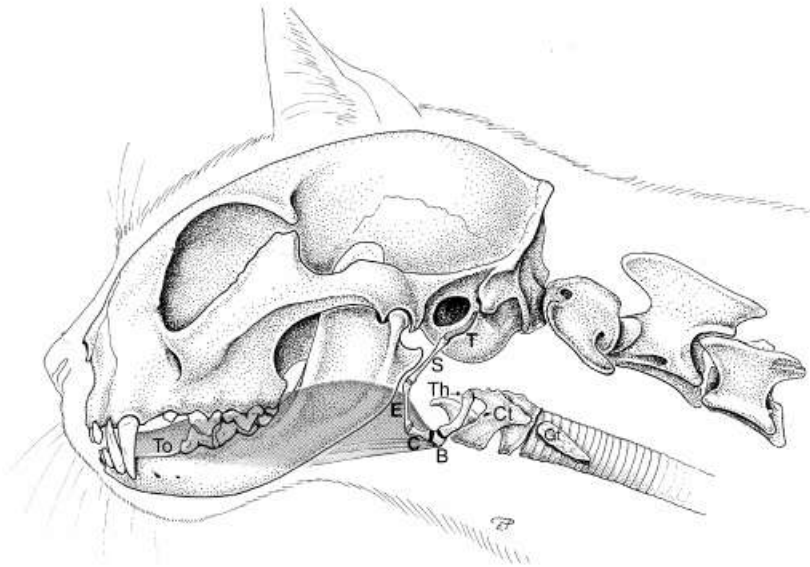

Fig. 8 Hyoid apparatus, larynx and cranial part of the trachea in the domestic cat. To, tongue; T, *Tympanohyoideum*; S, *Stylohyoideum*; E, *Epihyoideum*; C, *Ceratohyoideum*; B, *Basiyoideum*; Th, *Thyrohyoideum*; Ct, *Cartilago thyroidea*; Gt, *Glandula thyroidea*.



Fig. 9 *Tympanohyoideum* (on top) and bony *Stylohyoideum* of the lion (lateral view; right = caudal). Arrowheads indicate the beginning (dorsal) and the end (ventral) of the rotated part of the tympanohyal cartilage.

head of origin on the dorsal end of the *Stylohyoideum*. In the *Panthera* species the *M. stylopharyngeus caudalis* has its small origin on the dorsal part of the *Tympanohyoideum*, then widens, and lies between the *Mm. constrictores pharyngis rostrales* and the *M. hyopharyngeus* in the lateral wall of the pharynx. In the *Panthera* species almost all origins of the mentioned muscles are located dorsal of the rotated, ventral part of the *Tympanohyoideum*.

***Stylohyoideum* and associated muscles**

In the lion, the tiger and the adult jaguar the ventral end of the *Stylohyoideum* is located ventral and caudal or caudolateral of the *Tympanohyoideum* (Figs 2–4 and 13). Only the *Stylohyoideum* of the tiger has a ventral cartilaginous part. In all examined species the dorsal end of the *Stylohyoideum* is connected with the *Tympanohyoideum* via a synchondrosis. In the *Panthera* species the *Ligamentum (Lig.) epihyoideum* originates on the medial surface of its ventral end. The stylohyal bone is located medial of the *Mm. styloglossus* and *stylohyoideus*, its ventral end lies lateral to the *M. stylopharyngeus caudalis* (Fig. 11). In the cheetah and the domestic cat the stylohyal bone runs rostroventrally and the bony *Epihyoideum* is connected via a synchondrosis (Figs 6–8). In the adult jaguar, the cheetah and the domestic cat a small part of the *M. styloglossus* originates on the dorsal end of the stylohyal bone.



Fig. 10 Cartilaginous *Tympanohyoideum* (on top) and bony *Stylohyoideum* of lion, tiger and jaguar. Left: lion, male, left body side, left-lateral aspect. Middle: tiger, female, right body side, right-lateral aspect. Right: jaguar, male, left body side, left-lateral aspect. Graduation in cm (numbers) and mm.

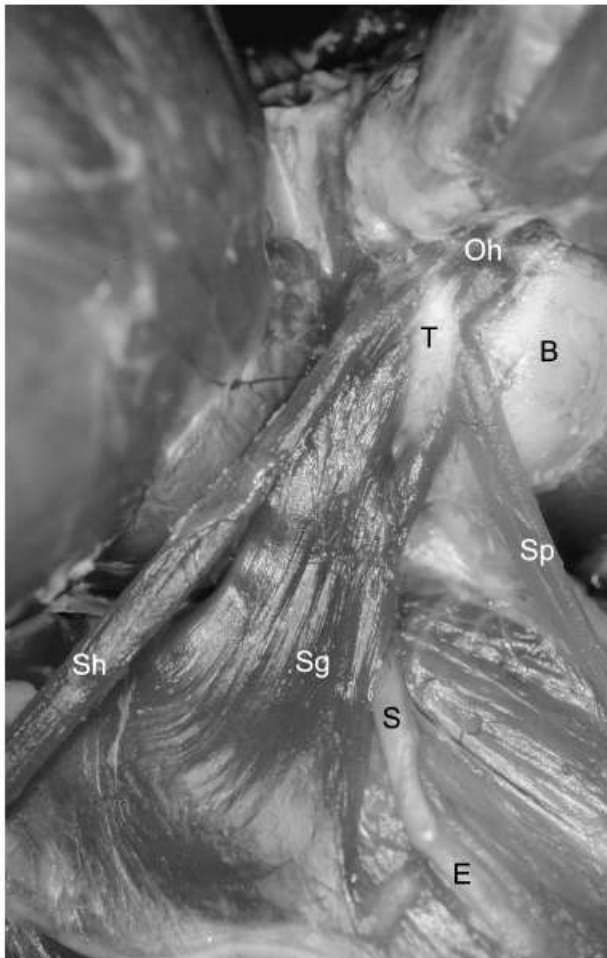

Fig. 11 *Fossa retromandibularis* in the tiger after removal of the skin and the parotis (lateral view, right = caudal). Sh, *M. stylohyoideus*; Sg, *M. styloglossus*; T, *Tympanohyoideum*; S, *Stylohyoideum*; E, *Epihyoideum*; Oh, *M. occipitohyoideus*; B, *Bulla tympanica*; Sp, *M. stylopharyngeus caudalis*.

Epihyoideum and associated muscles

The *Epihyoideum* of the lion, tiger and jaguar (newborn and adult) is a ligamentous structure consisting of elastic and collagenous fibres and therefore named *Lig. epihyoideum* (Figs 2–4, 14–16). In the dorsal part of the lion's *Lig. epihyoideum* (at a distance of approximately 22 mm from the *Stylohyoideum*) a small bony structure (10 mm in length) is embedded within the ligament (Figs 16 and 17). The ligamentous *Epihyoideum* of the three *Panthera* species studied runs caudoventrally and attaches to the medial surface of the rostral part of the *Ceratohyoideum*. The entire *Lig. epihyoideum* of the lion, tiger and jaguar is situated within the lateral pharyngeal wall, its ventral part running between the lateral *M. hyoglossus* and the medial *Mm. ceratohyoideus* and *thyroglossus*. In the examined *Panthera* species few muscle fibres of the *M. ceratohyoideus* insert on the ventral part of the *Lig. epihyoideum* (Fig. 18).

Ceratohyoideum and associated muscles

The *Ceratohyoideum* of all examined species is a rod-shaped bone and situated in a sagittal plane, but in the *Panthera* species its caudal end lies more lateral than the rostral. In all examined species its caudal end has a synovial articulation with the *Basihyoideum*. In the cheetah and the domestic cat a synovial joint is also present between the bony *Epihyoideum* and the *Ceratohyoideum*.

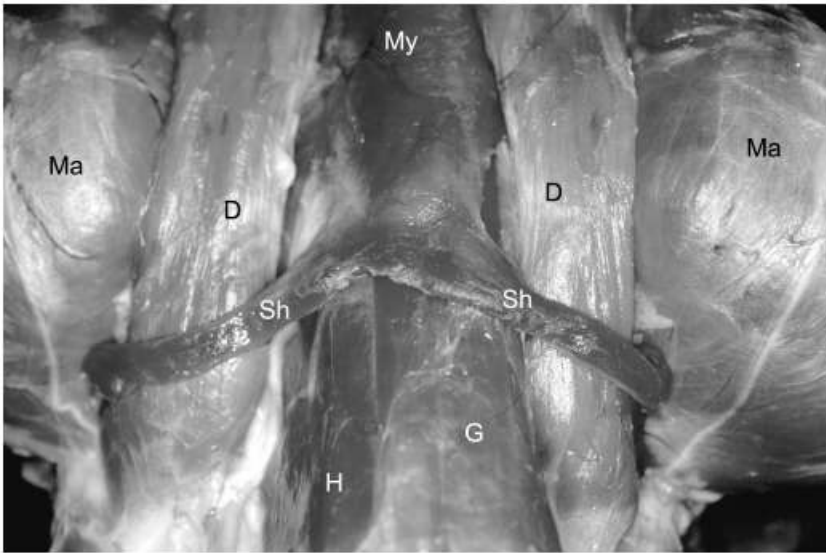

Fig. 12 Regiones mandibularis, intermandibularis and subhyoidea in the tiger after removal of the skin (ventral view). My, *M. mylohyoideus*; Ma, *M. masseter*; D, *M. digastricus*; Sh, *M. stylohyoideus*; G, *M. geniohyoideus*; H, *M. hyoglossus*.

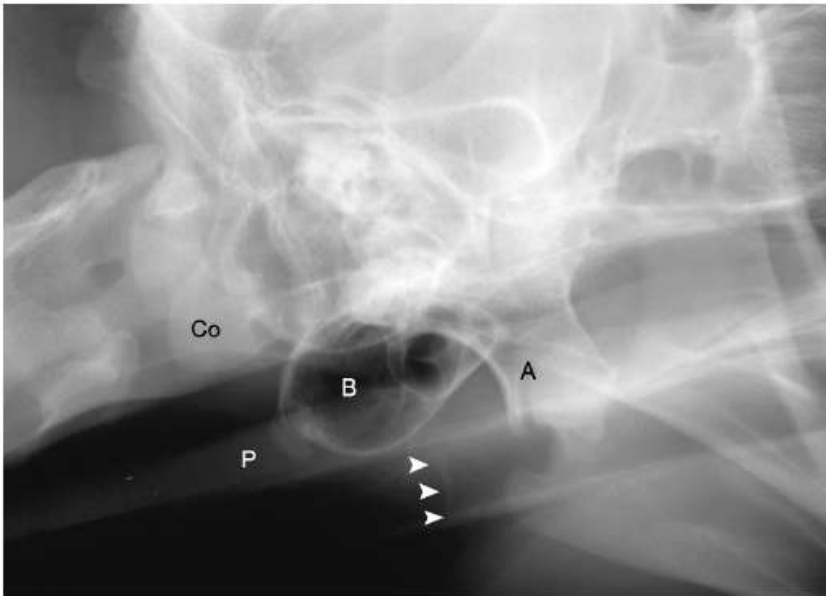

Fig. 13 Radiograph of the upper neck region of an intubated lion (lateral view, left = caudal). Co, *Condylus occipitalis*; P, soft palate; B, *Bulla tympanica*; A, *Articulatio temporomandibularis*; arrowheads, *Stylohyoideum*.



Fig. 14 *Stylohyoideum* (S), *Epiphyoideum* (E), and *Ceratohyoideum* (C) of a newborn jaguar (histological section, HE stain). Scale bar = 400 μ m.

The *M. ceratohyoideus*, which in the *Panthera* species lies between the lateral *Mm. hyopharyngeus* or *hyoglossus* and the medial *M. thyroglossus*, inserts on the *Ceratohyoideum*. The *Mm. hyopharyngeus* and *hyoglossus* partly originate on the ceratohyal bone in all examined species.

***Basihyoideum* and associated muscles**

In all species studied the *Basihyoideum* lies in a transverse plane (Fig. 19). In the lion, cheetah and domestic cat the basihyal bone reveals a synovial articulation

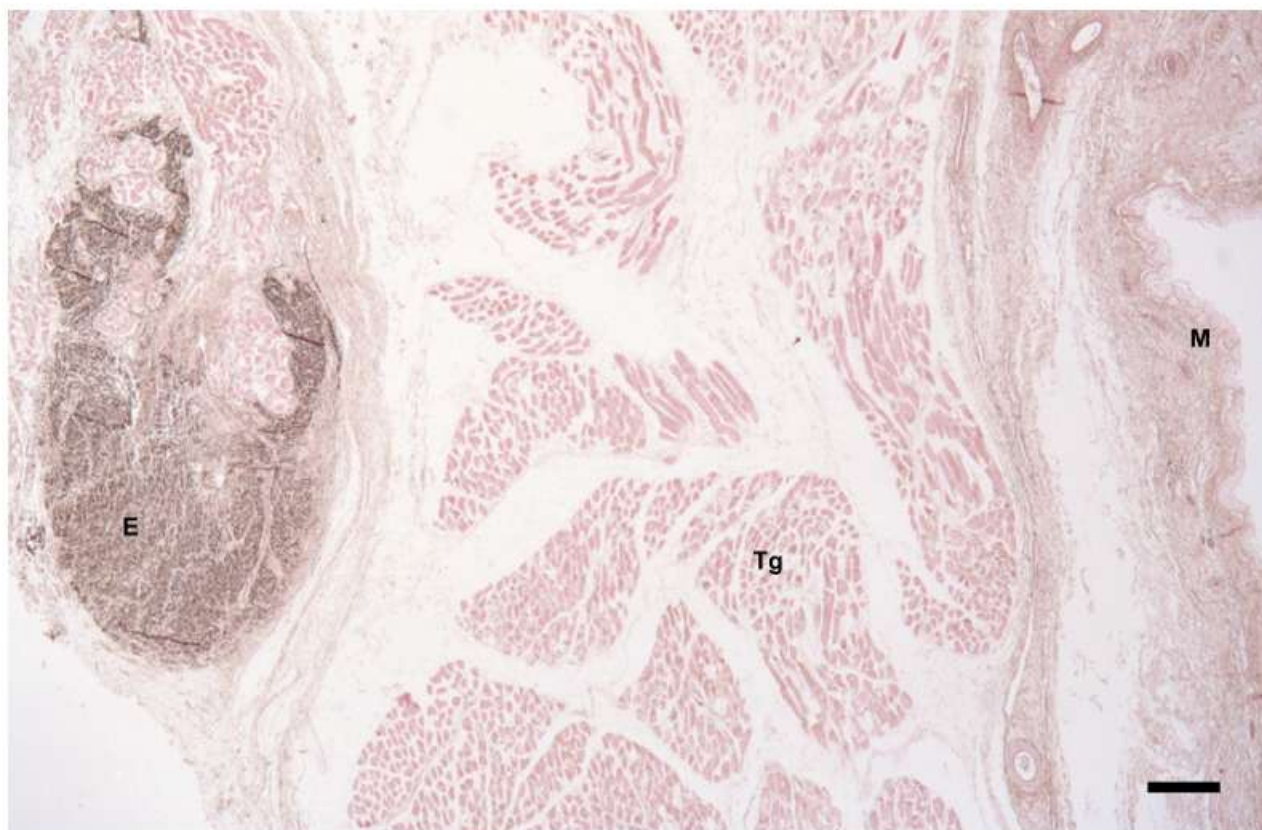

Fig. 15 Lateral pharyngeal wall of the jaguar (histological section, Weigert stain). E, epihyal ligament; Tg, *M. thyroglossus*; M, mucous membrane. Scale bar = 400 μ m.

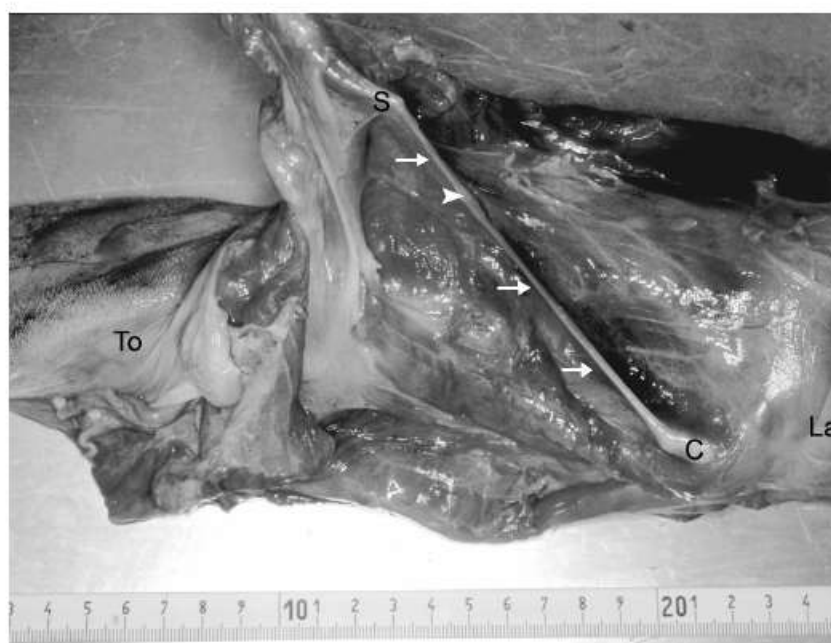

Fig. 16 Lateral pharyngeal wall in the lion. To, tongue; S, *Stylohyoideum*; C, *Ceratohyoideum*; La, larynx; arrows, *Epihyoideum*; arrowhead, position of the bone within the epihyal ligament.

with the *Thyrohyoideum*. In the tiger this joint is a synchondrosis (lateral) and a synovial articulation (medial). In the two adult jaguars a synostosis was present, which is possibly due to a more progressive age-dependent

ossification of that joint in these elderly specimens. In the lion, the jaguar and the tiger the distance between the *Basihyoideum* and the rostral border of the thyroid cartilage is 15–20 mm (Figs 2–4 and 19).



Fig. 17 Bone within the epihyal ligament of the lion (histological section, HE stain). Scale bar = 400 μ m.

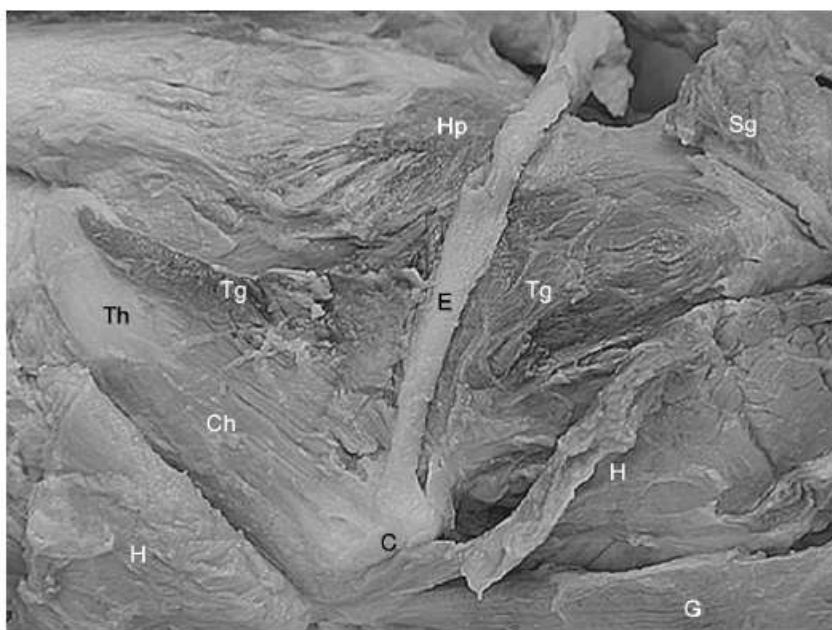

Fig. 18 Lateral pharyngeal wall in the lion (lateral view, left = caudal). Th, *Thyrohyoideum*; C, *Ceratohyoideum*; E, *Epihyoideum*; H, *M. hyoglossus* (dissected); Ch, *M. ceratohyoideus*; Tg, *M. thyroglossus*; Hp, *M. hyopharyngeus*; G, *M. geniohyoideus*; Sg, *M. styloglossus*.

The *M. geniohyoideus*, which is proportionally longer in the lion, the adult jaguar and the tiger than in the cheetah or the domestic cat (because of the topographical position of the *Basihyoideum*), terminates on the corpus of the basihyal bone. In all examined species the *M. hyoglossus* has an origin on the lateral part of the *Basihyoideum* and the *M. sternohyoideus* inserts caudoventral on the basihyoid. In the lion, the tiger and the adult jaguar the *M. hyoepiglotticus* is a distinct, Y-shaped muscle (dorsally fused, ventrally paired), running from the median, ventral surface of the epiglottic cartilage to the *M. hyoglossus* and the angle between the basihyal and the ceratohyal bone. In the lion it

inserts mainly on the *Ceratohyoideum*. In the cheetah and the domestic cat the *M. hyoepiglotticus* consists of few fan-shaped fibres. In all examined species the *M. hyopharyngeus* has an origin on the lateral part of the *Basihyoideum*.

Thyrohyoideum

The *Thyrohyoideum* of the lion, tiger and adult jaguar consists of a ventral bone and a dorsal cartilage (Figs 2–4). An additional short cartilage at the ventral end of the *Thyrohyoideum* can be observed in the lion. In the adult jaguar and the lion the caudodorsal tip of the

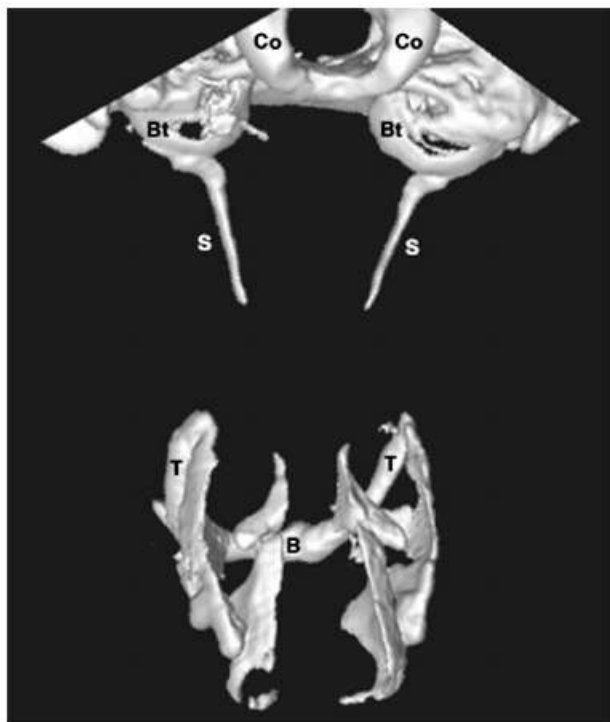

Fig. 19 CT-image of the head and neck of an adult tiger, 3-D reconstruction (caudal view). Co, *Condylus occipitalis*; Bt, *Bulla tympanica*; S, *Stylohyoideum*; B, *Basihyoideum*; T, *Thyrohyoideum*. The cartilages of the larynx are caudally attached to the *Thyrohyoideum*.

thyrohyal cartilage is caudally elongated and attaches to the *Cornu rostrale* of the thyroid cartilage via an elastic ligament. In the *Panthera* species studied the *Cornu rostrale* lies caudomedial to the dorsal end of the *Thyrohyoideum*. The ligament between thyrohyal and thyroid cartilage measures approximately 10 mm

in the jaguar. In the lion it is shorter and more delicate than in the jaguar. In the tiger the *Articulatio thyrohyoidea* is a synovial joint with a taut capsule (Fig. 3). In the cheetah and the domestic cat the *Thyrohyoideum* consists of a bone with a narrow cartilaginous border on its dorsal end. In the last-mentioned two species the *Cornu rostrale* of the thyroid cartilage is located dorso-medial of the *Thyrohyoideum* and connected via short, taut ligaments (Figs 6–8).

In all felid species studied the *M. hyoglossus* has its origin on the ventrolateral surface and rostral edge of the *Thyrohyoideum*. The triangle-shaped *M. ceratohyoideus* originates on the dorsorostral border and dorsolateral surface of the *Thyrohyoideum*. The *M. thyrohyoideus* inserts on the ventral half of the *Thyrohyoideum*. In the lion, the tiger and the jaguar an additional muscle can be described, which we name *M. thyroglossus*. This flat muscle, originating on the rostral border of the *Thyrohyoideum*, is partly fused with the *M. ceratohyoideus* but runs rostrally and enters the tongue between the *Mm. hyoglossus* and *genioglossus*. The flat *M. hyopharyngeus* originates on the lateroventral surface of the *Thyrohyoideum* and lies superficial to the *Mm. ceratohyoideus* and *thyroglossus*.

Pharynx

In the lion, the tiger and the adult jaguar the pharyngeal wall is caudally elongated showing numerous longitudinal folds on its inner surface. As compared with the cheetah and the domestic cat the enormous pharyngeal elongation is caused by the expansion of the *Pars nasalis* and *Pars oralis pharyngis*, which in the

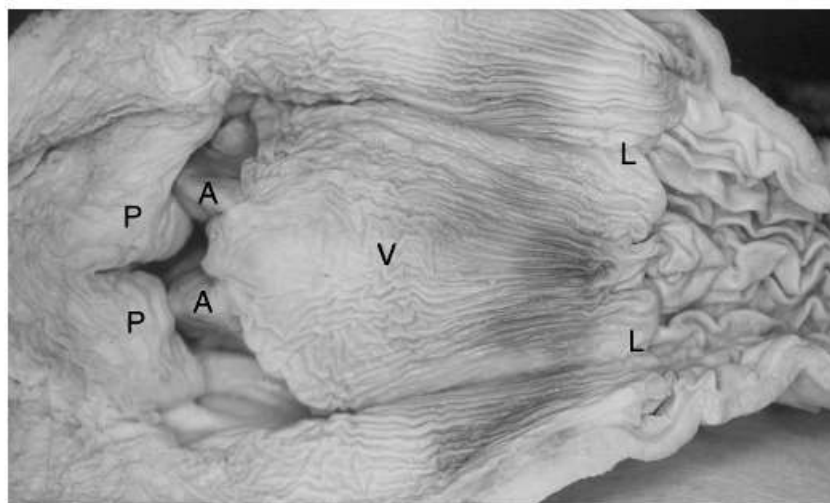

Fig. 20 *Vestibulum oesophagi* in the jaguar (dissected, dorsal view). P, soft palate; A, arytenoid cartilage; V, *Vestibulum oesophagi*; L, *Limen pharyngooesophageum*.

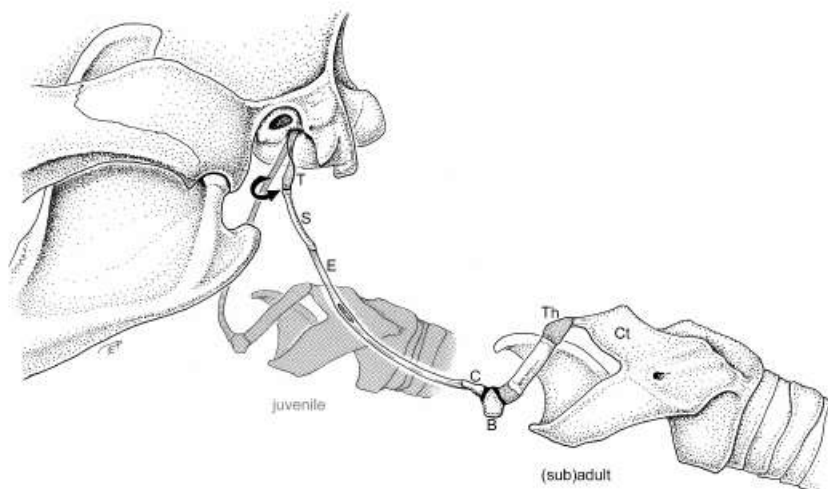

Fig. 21 Ontogenetic development of the hyoid apparatus and topographical position of the larynx in the Pantherinae. The individual designated as '(sub)adult' represents a lion. Arrow indicates the rotation within the *Tympanohyoideum* (T). S, *Stylohyoideum*; E, *Epihyoideum*; C, *Ceratohyoideum*; B, *Basihyoideum*; Th, *Thyrohyoideum*; Ct, *Cartilago thyroidea*.

Panthera species are separated by an elongated *Velum palatinum*. The length of the *Pars oralis pharyngis*, measured from the caudal end of the *Radix linguae* to the *Basihyoideum*, is 7.5 cm in the lion, 7 cm in the jaguar and 5.5 cm in the tiger, whereas in the cheetah and the domestic cat it is less than 1 cm. Besides the muscles, numerous collagenous and elastic fibres can be observed within the lateral pharyngeal walls and the soft palate. In the Pantherinae examined an extensive and voluminous venous network (*Rete mirabile*) is developed within the submucosal layer of the *Vestibulum oesophagi* rostral to the *Limen pharyngoesophageum* (Fig. 20).

The length of the entire *Velum palatinum* is approximately 20 cm in the lion, 16 cm in the male adult jaguar, and 13 cm in the tiger and the female adult jaguar. In all *Panthera* species examined the free border of the elongated *Velum palatinum* is located dorsal of the arytenoid cartilage (Fig. 20) and therefore dorsal of the glottis. In the domestic cat and the cheetah the caudal end of the velum is situated dorsal of the *Apex epiglottidis*. Left and right *Mm. palatinus*, which are distinct muscles in the examined *Panthera* species and the cheetah, run parallel to the median plane from the hard palate to the caudal end of the velum. In the tiger a small, *Uvula*-like projection on the free border can be observed. In the lion, the tiger and the jaguar the *Arcus palatopharyngeus* follows the dorsal edge of the thyroid cartilage and an *Arcus palatoglossus* is lacking. In the cheetah and the domestic cat the *Arcus palatopharyngeus* is situated more rostrad than in the *Panthera* species.

Besides the pharyngeal muscles, which are described with the hyoid apparatus, a few other muscles running and terminating in the pharyngeal wall can be found.

In the lion, tiger and adult jaguar the *M. cricopharyngeus* is smaller than the *M. thyropharyngeus*. The *Mm. tensor veli palatini*, *levator veli palatini*, *palatopharyngeus* and *pterygopharyngeus* have not been investigated in detail, but are present in all examined species.

Discussion

Comparative morphology and ontogenetic development

Although the small number of individuals examined does not allow full generalization we feel that it is justified to proceed on the assumption that the structures described are representative of their respective species and ontogenetic stage, given the general agreement between our findings and previous publications (Owen, 1835; Pocock, 1916).

In contrast to Fürbringer (1922), but in accordance with Pocock (1916), we think that the ligamentous element within the *Apparatus hyoideus* of the Pantherinae is a *Lig. epihyoideum*. Although the anatomical descriptions of the *Tympanohyoideum*, *Stylohyoideum*, *Epihyoideum* and *Ceratohyoideum* by Pocock (1916) are quite similar to our findings, the author did not mention the articulations between the elements of the hyoid apparatus and larynx. He did not designate a *Tympanohyoideum* in a young jaguar, but observed a joint within a '*Stylohyoideum*', which probably represents the connection between tympanohyal and stylohyoid. The rotation within the tympanohyal cartilage has never been described before and seems to be unique among vertebrates (Fürbringer, 1922).

In the red deer (*Cervus elaphus*) and fallow deer (*Dama dama*) *Thyrohyoideum* and thyroid cartilage are linked by an elastic ligament, which plays a decisive role in the mechanism of lowering the larynx during the production of the roaring vocalizations of male individuals during rut (Fitch & Reby, 2001). The lion and the jaguar also possess a ligamentous connection between *Apparatus hyoideus* and larynx, whereas the tiger has a synovial articulation (Kurz, 1926; Schneider, 1964). Considering the differences in this joint, the shape of the ceratohyal bone, the length of the epihyal ligament as well as the breadth and shape of the stylohyal bone and the *Tympanohyoideum* it can be assumed that lion and jaguar are more similar to each other than to the tiger and that the tiger occupies a special position among the examined Pantherinae.

Luckhaus (1969) was the first to recognize the actual extent of the caudal position of the larynx and the elongated pharynx in the lion. The present study additionally documents the far caudal position of the *Basihyoideum* and the larynx in the tiger and the jaguar. The morphological similarities of the hyoid apparatus and the pharynx between the remaining species of the subfamily Pantherinae, i.e. the leopard (*Panthera pardus*) and the snow leopard (*Uncia uncia*), and the pantherine species we studied suggest that in the five species of the Pantherinae (we do not consider the marbled cat [*Pardofelis marmorata*] to be species of the Pantherinae) the structure of the hyoid apparatus and the pharynx as well as the topographical position of the larynx clearly differ from the other two subfamilies (*Felinae*, *Acinonychinae*) of the Felidae. The larynges of the lion, tiger and jaguar (and very likely leopard and snow leopard) are situated much more caudal than in other species of the Felidae and the majority of other mammal taxa except humans, some bats (Schneider, 1964; Luckhaus, 1969), the koala (Sonntag, 1921), and red or fallow deer (Fitch & Reby, 2001). Since it is not clear which position of the larynx is 'normal' in living individuals of the big cat species we can make no statement whether the species of the Pantherinae lower the position of their larynx during the production of certain vocalizations. It is likely that in Pantherinae the normal resting position of the larynx is low (5th to 7th cervical vertebra) and, due to the shortness of the cervical part of the trachea, the overlapping tracheal cartilages, and the limited space between the first ribs, the main movements of the *Basihyoideum* and the attached larynx should be in a rostral direction.

The content of elastic fibres within the pharyngeal wall of the felid species studied is similar to that of the walls of the *Vestibulum oesophagi* and the *Velum palatinum* in domestic carnivores described by Jaenicke (1908) and Hellfors (1913). A venous *Rete mirabile*, which in the present study was observed within the wall of the *Vestibulum oesophagi*, is also found in humans, horses, cattle, domestic pigs and dogs (Elze, 1918; Baier, 1929). Baier (1929) mentioned that the *Rete* plays a role in 'closing' the oesophagus.

In a lion Diekmann (1932) described a 'posterior part of the *M. genioglossus*'. This muscle is also present in the species of the Pantherinae we examined in the present study, but we choose to name it '*M. thyroglossus*'. This designation indicates its origin and termination and, moreover, this muscle has nothing to do with the *M. genioglossus*.

In contrast to Owen (1835), who stated that in the lion 'the tongue is proportionately increased in length', our findings are that in the lion, tiger and jaguar the distance between the *Radix linguae* and the epiglottis is proportionally much longer than in other felids such as the domestic cat or cheetah.

In the examined Pantherinae it seems unlikely that during nasal respiration the long *Velum palatinum* attaches to the ventral wall of the *Pars oralis pharyngis* and that its caudal end lies ventral of the epiglottis. This 'breathing'-position of the velum occurs in the domestic cat, dog or horse (Némai, 1912; Nickel & Wilkens, 1987; König, 1992; Schaller, 1992). In the *Panthera* species we examined in the present study it is more likely that the soft palate, usually lying dorsal of the epiglottis, can hardly be moved ventrally. Hence a dorsal movement of the soft palate, closing off the nasal passage, known to occur in other mammals during loud calls (Fitch, 2000b), is also likely in the Pantherinae.

Based on our findings of the position of the larynx in neonate and adult jaguars described above we postulate that the *Basihyoideum*, the *Thyrohyoideum* and the attached larynx change their position from rostral to caudal during postnatal development (Fig. 21) in the five felid species with a ligamentous *Epihyoideum*, i.e. lion, leopard, jaguar, tiger and snow leopard. Thus, the 'descensus' of the larynx is no longer a specific pattern occurring at puberty in humans (Harries et al. 1998) and as a temporary phenomenon during the production of a specific vocalization type in red and fallow deer (Fitch & Reby, 2001). The exact timing and course

of neither the descent of the larynx nor the rotation of the ventral end of the *Tympanohyoideum* can be determined at present.

Topographical position of the larynx and vocalization

The anatomical findings presented here on the relative topographical position of the larynx in the Felidae and its descent during ontogeny in some species have important implications for vocal tract length and hence specific structural characters of the species' vocalizations (Fitch, 1997, 2000a, 2000b, Fitch & Reby, 2001). Ever since Owen (1835) it has been postulated that there is a correlation between the degree of ossification of the hyoid bones in this carnivore family and the presence or absence, respectively, of purring and roaring in its various species, the species with a fully ossified hyoid (subfamilies *Felinae* and *Acinonychinae*) being able to purr but not to roar and the only five felid species with a partly ligamentous hyoid (subfamily Pantherinae: lion, leopard, jaguar, tiger, snow leopard) being able to roar but not to purr. Peters & Hast (1994) discussed this hypothesis in some detail and concluded that no such specific correlation can be substantiated based on the data available then. On the other hand they argued that '... a hyoid with an elastic ligament instead of a bony epihyoid ... allows for an elongation of the supraglottal vocal tract, i.e. the distance of the sound generator from the mouth, which results in lower pitch of calls'. This conclusion is incorrect as such an elongation does not result in a lowering of the pitch (which is determined by the call's fundamental frequency) but a lowering of its formant frequencies (Fitch, 1997, 2000a, 2000b, Fitch & Reby, 2001). Based on the morphological findings presented here we bring forward two hypotheses:

1 Because of the relatively more caudal position of the larynx in the five felid species with an incompletely ossified hyoid (subfamily Pantherinae) their vocalizations are predicted to have formant frequencies that lie significantly below the allometric curve of this parameter for the other species of the Felidae.

2 If the ontogenetic change in the relative topographical position of the larynx in the jaguar is representative of the four other felid species with an incompletely ossified hyoid, the ontogenetic descent of the larynx in the five pertinent species is reflected in a pronounced decrease of formant frequency dispersion during ontogeny. The progress and extent of this decrease is

different from the 'normal' ontogenetic change of this character in the voice of the other Felidae. An ensuing study of the hyoid apparatus and pharynx of felids at different stages of their ontogeny and the analyses of their juvenile vocalizations is planned to test these hypotheses.

Studies of vocal ontogeny in the five *Panthera* species will also have to heed the fact that lion, jaguar, leopard and tiger have 'a large pad of fibroelastic tissue which constitutes the rostral portion of each of the proportionally very large undivided vocal folds' (Hast, 1986, 1989). The other 10 felid species studied then have 'a larynx with divided thyroarytenoid folds, with a depression between the rostral and the caudal folds ... and a vocal fold with a sharp edge'. The latter seems to be the standard situation in all other species of the Felidae (an additional five species studied by Peters & Hast, 1994), with the exception of the snow leopard which has an intermediate vocal fold morphology. Pads located on the vocal folds are already present in the neonate jaguars we studied but the ontogenetic development of the vocal folds in the jaguar and the other four species of Pantherinae is not well enough documented yet to make any substantiated statements. The pronounced proportional enlargement of the vocal folds mainly affects fundamental frequency in the species' vocalizations.

A better understanding of the vocal anatomy of the Pantherinae puts us in a position to offer a tentative definition of 'roaring', which has till now been a confusing and elusive notion, in acoustic terms. We suggest that roaring (the low pitch vocalization seen in prototypical form in lions and red deer) has two distinct physiological and acoustic components:

1 a low fundamental frequency, made possible by long or heavy vocal folds, which lead to the low pitch of the roar; **2** lowered formant frequencies, made possible by an elongated vocal tract, which provide the impressive baritone timbre of roars.

Thus it is possible to have low-pitched calls that are not roars (e.g. a bullfrog vocalization has a low fundamental but is not a 'roar'), or calls with low formants that are not roars (e.g. the trumpet call of cranes).

The distinction between 'roaring' and 'purring' can also be tentatively clarified in terms of the function of the vocal anatomy. Purring is caused by extremely rapid twitching of the vocalis muscle (running within the vocal folds) (Hirose et al. 1969; Remmers & Gautier, 1972; Frazer Sissom et al. 1991). A large flexible pad like that seen in the vocal folds of the Pantherinae

would tend to damp such twitchings and thus make it difficult, if not impossible, to purr. However, the elastic epihyoid of the Pantherinae has an independent function: allowing the lowering of the larynx, with concomitant lowering of formant frequencies. This adaptation is in principle quite independent of any change in the larynx, and thus has no direct effect on the ability to purr.

Acknowledgments

We thank Mag. Eva Polsterer for outstanding artwork, Leopold Hnilitza, Institute of Anatomy, VUW Vienna, for technical assistance, Dr Katharina Hittmair and Mag. Martin Konar, both Radiology Clinic, VUW Vienna, for radiographic and MR imaging, and Professor William Peake (Eaton Peabody Laboratories, USA) and Dr Darlene Ketten (Woods Hole Oceanographic Institute, USA) for access to and CT imaging of the male tiger. We appreciate co-operation with the Vienna Schönbrunn Zoo and the Safaripark Gänserndorf.

References

- Baier W** (1929) Über Venennetze am Speiseröhreneingang bei den Haussäugetieren. *Berliner Tierärztliche Wochenschrift* **45**, 625–626.
- Diekmann E** (1932) Der Kehlkopf des Löwen mit besonderer Berücksichtigung seiner Geschlechtsunterschiede. *Z. Anat. Entwicklungsgeschichte* **98**, 527–547.
- Elze C** (1918) Die venösen Wundernetze der Pars laryngea pharyngis. *Anat. Anzeiger* **51**, 205–207.
- Fitch WT** (1997) Vocal tract length and formant frequency dispersion correlate with body size in rhesus macaques. *J. Acoust. Soc. Am.* **102**, 1213–1222.
- Fitch WT** (2000a) Skull dimensions in relation to body size in nonhuman mammals: The causal bases for acoustic allometry. *Zoology* **103**, 40–58.
- Fitch WT** (2000b) The phonetic potential of nonhuman vocal tracts: Comparative cineradiographic observations on vocalizing animals. *Phonetica* **57**, 205–218.
- Fitch WT, Reby D** (2001) The descended larynx is not uniquely human. *Proc. Royal Soc. London B* **268**, 1669–1675.
- Frazer Sissom DE, Rice DA, Peters G** (1991) How cats purr. *J. Zool. (London)* **223**, 67–78.
- Fürbringer M** (1922) Das Zungenbein der Wirbeltiere insbesondere der Reptilien und Vögel. *Abhandlungen Heidelberger Akademie Wissenschaften, Mathematisch-Naturwissenschaftliche Klasse, Abt. B* **11**, 1–164.
- Harries M, Hawkins S, Hacking J, Hughes I** (1998) Changes in the male voice at puberty: vocal fold length and its relationship to the fundamental frequency of the voice. *J. Laryngol. Otol.* **112**, 451–454.
- Hast MH** (1986) The larynx of roaring and non-roaring cats. *J. Anat.* **149**, 221–222.
- Hast MH** (1989) The larynx of roaring and non-roaring cats. *J. Anat.* **163**, 117–121.
- Hellfors JA** (1913) *Die Verbreitung und Anordnung des elastischen Gewebes in den einzelnen Wandschichten des Oesophagus einiger Haustiere*. Thesis, Königliche Tierärztliche Hochschule zu Dresden.
- Hirose H, Ushijima T, Kobayashi T, Sawashima M** (1969) An experimental study of the contraction properties of the laryngeal muscles in the cat. *Ann. Otol. Rhinol. Laryngol.* **78**, 297–306.
- Jaenicke H** (1908) *Vergleichende anatomische und histologische Untersuchungen über den Gaumen der Haussäugetiere*. Thesis, Königliche Tierärztliche Hochschule zu Dresden.
- König HE** (1992) *Anatomie der Katze mit Hinweisen für die tierärztliche Praxis*. Stuttgart: Gustav Fischer.
- Kurz E** (1926) Beschreibung des Kehlkopfes einer 18jährigen Tigerin. *Z. Anat. Entwicklungsgeschichte* **81**, 436–447.
- Luckhaus G** (1969) Vergleichend-anatomische Betrachtungen über den Pharynx des Löwen mit Berücksichtigung der mikroskopischen Anatomie seiner Tonsilla palatina. *Zentralblatt Veterinärmedizin, Reihe A* **16**, 240–256.
- Lykaki G, Papadopoulos N** (1988) The ossified hyoid apparatus – Morphology, interpretation, clinical and functional significance. *Anat. Anzeiger, Jena* **166**, 187–193.
- Nakano T, Muto H, Yoshioka I** (1988) Anatomical studies in the hyoid region of the mouse in term of evolutionary importance. *Anat. Anzeiger, Jena* **167**, 105–112.
- Neff NA** (1982) *The Big Cats – the Paintings of Guy Coheleach*. New York: Abrams.
- Némaj J** (1912) Vergleichend-anatomische Studien am Kehlkopf der Säugetiere. *Arch. Laryngol. Rhinol.* **26**, 451–508.
- Nickel R, Wilkens H** (1987) Atmungsapparat. In *Lehrbuch der Anatomie der Haustiere* (eds Nickel R, Schummer A, Seiferle E), Band II, Eingeweide, 6. Aufl., pp. 219–299. Berlin: Paul Parey.
- Owen R** (1835) On the anatomy of the cheetah, *Felis jubata*, Schreb. *Trans. Zool. Soc. London* **1**, 129–136.
- Peters G, Hast MH** (1994) Hyoid structure, laryngeal anatomy, and vocalization in felids (Mammalia: Carnivora: Felidae). *Z. Säugetierkunde* **59**, 87–104.
- Pocock RI** (1916) On the hyoidean apparatus of the lion (*F. leo*) and related species of Felidae. *Ann. Magazine Natural History, Zoology, Bot. Geol.* **8**, 222–229.
- Pocock RI** (1917) The classification of existing felidae. *The Annals and Magazine of Natural History, 8th Series, no. 119*, **20**, 329–350.
- Remmers JE, Gautier H** (1972) Neural and mechanical mechanisms of feline purring. *Respiration Physiol.* **16**, 351–361.
- Schaller O** (1992) *Illustrated Veterinary Anatomical Nomenclature*. Stuttgart: Enke.
- Schneider R** (1964) Der Larynx der Säugetiere. In *Handbuch der Zoologie* (eds Helmcke JG, Lengerken H, Starck D, Wermuth H), VIII, Teil 5, pp. 1–127. Berlin: de Gruyter.
- Sonntag CF** (1921) The comparative anatomy of the Koala (*Phascolarctos cinereus*) and Vulpine Phalanger (*Trichosurus vulpecula*). *Proc. Zool. Soc. London* **39**, 547–577.
- Wozencraft WC** (1993) Order Carnivora. In *Mammal Species of the World. A Taxonomic and Geographic Reference* (eds Wilson DE, Reeder DM), 2nd edn, pp. 279–348. Washington, DC: Smithsonian Institution Press.