

# Reconfiguration of Power Distribution Systems Considering Reliability and Power Loss

B. Amanulla, *Student Member, IEEE*, Saikat Chakrabarti, *Senior Member, IEEE*, and  
S. N. Singh, *Senior Member, IEEE*

**Abstract**—A power distribution system reconfiguration methodology considering the reliability and the power loss is developed in this paper. Probabilistic reliability models are used in order to evaluate the reliability at the load points. An algorithm for finding the minimal cut sets is utilized to find the minimal set of components appearing between the feeder and any particular load point. The optimal status of the switches in order to maximize the reliability and minimize the real power loss is found by a binary particle swarm optimization-based search algorithm. The effectiveness of the proposed methodology is demonstrated on a 33-bus and a 123-bus radial distribution system.

**Index Terms**—Binary particle swarm optimization (BPSO), distribution system reconfiguration, minimal cut set, power loss, probabilistic reliability model.

## I. INTRODUCTION

**D**UE TO the rapid increase in the demand for electricity, environmental constraints, and the competitive energy market scenario, the transmission and distribution systems are often being operated under heavily loaded conditions. In the earlier days, evaluation of the adequacy of the generation system and reliability of the transmission system were among major studies in the system planning. The recent experiences from blackouts indicate that, in many cases, the triggering events for such widespread failures took place in the distribution level [1]. Statistically, the majority of the service interruptions to the customers come from the distribution systems [2], [3]. Detailed reliability evaluation of the distribution system has, therefore, become very important in the planning and operating stage of a power system. For economic reasons, minimization of the losses in the distribution system should also be considered in a distribution system reconfiguration process.

The commonly used objectives for distribution system reconfiguration have been the minimization of the transmission loss and/or voltage deviations (from the nominal values) at the buses [4]–[17]. An essential criterion for the reconfigured networks has been the preservation of the radial nature, mainly for the

ease in protective relay coordination. The probabilistic reliability evaluation methodology described in this paper is, however, not limited to radial distribution networks only. Distribution reconfiguration is essentially a combinatorial optimization problem where the best possible combination of status (open or close) of the sectionalizing and tie-switches has to be found so that the objective function (such as the total real power loss) is minimized. The frequently used constraints in this optimization process have been the maximum-allowable voltage drop in the line, line current limits, transformer capacity limits, and any other possible network operational or planning constraints.

In [4]–[7], branch exchange-based techniques are employed to find the optimal network configuration, where an open switch is closed, and a closed switch is opened to maintain the radial configuration of the network. Simplified versions of power-flow computation methods that are suitable for radial networks are used to minimize the computational burden and speed up the search process. A linear programming-based distribution system reconfiguration method is proposed in [8], where, by using a modified simplex method, the optimal configurations of the switches (i.e., close or open status) are determined. The artificial intelligence-based methodologies, such as the use of fuzzy variables, genetic algorithm, simulated annealing, ant colony systems, and other evolutionary techniques have increasingly been used for the distribution system reconfiguration problem [9]–[17]. Two clearly distinct advantages of these methods are the avoidance of local minima, if any, and better handling of multiple objectives and constraints that are not always easy to formulate in a conventional optimization problem.

The objective of a reliability-driven design of a distribution system is to reduce the frequency and duration of power interruptions to the customers [3]. This implies the reduction in the number of customers affected by individual faults, reduction in the time needed to locate and isolate a fault, thereby, reduces the time required to restore power to the affected customers, and strengthening of the power network by improving the existing power lines and installing new power lines and equipment, if required.

In recent years, there has been some works reported on addressing the reliability issues while reconfiguring the distribution networks [18]–[21]. The majority of these works use computational intelligence-based methods to obtain the optimal switch configuration that maximizes the reliability of the system. The expected energy not supplied (EENS), expected outage cost (ECOST), and system average interruption duration index (SAIDI) are some of the widely used reliability indices in these approaches.

Manuscript received July 15, 2011; revised October 19, 2011, November 25, 2011, and November 30, 2011; accepted November 30, 2011. Date of publication January 24, 2012; date of current version March 28, 2012. Paper no. TPWRD-00600-2011.

B. Amanulla is with the Ashok Leyland Technical Centre, Chennai 600103, India (e-mail: amanbasha.a@gmail.com).

S. Chakrabarti and S. N. Singh are with the Department of Electrical Engineering, Indian Institute of Technology, Kanpur UP 208016, India (e-mail: saikatc@iitk.ac.in; snsingh@iitk.ac.in).

Digital Object Identifier 10.1109/TPWRD.2011.2179950

The reliability evaluation method followed so far in the distribution reconfiguration problem is based on the  $N - 1$  criterion, where the effect of failure of a component on the power supplied to the load or customer is quantified [22]. The failure history of the component is utilized to compute the failure rates. However, to predict the performance of the system in the future, one needs to rely on probabilistic description of various failure events.  $N - 1$  criterion fails to account for different probabilities of various contingencies to occur. Also, it does not take into consideration the factors, such as the risks associated with various operating stages and times of a power system, the aging of equipment, and the growth of loads.

In this paper, probabilistic models of the distribution system components are considered while evaluating the reliability at the load points. Minimal cut sets between the source and the load points are first determined, and then the expected availability of power is computed by using the joint failure probability distribution of the components involved in the cut set. The binary particle swarm optimization (BPSO) technique is used to determine the optimal configuration of switches in the network in order to maximize the reliability at the load points, and minimize the real power loss in the system. One of the contributions of this paper lies in formulating the distribution system reconfiguration problem in a multiobjective framework, considering reliability and power loss. Another contribution is the methodology by which probabilistic reliability evaluation can be used in the reconfiguration problem, which is otherwise not possible with the commonly used Monte Carlo simulations due to very large computational time.

Section II gives an overview of the probabilistic reliability assessment technique used in this paper. Section III provides an overview of distribution system power loss assessment. A description of the BPSO algorithm and the formulation of the optimization problem are presented in Section IV. Simulation results are presented in Section V, and Section VI concludes this paper.

## II. PROBABILISTIC RELIABILITY ASSESSMENT

The reconfiguration methodology followed in this paper is aimed at maximizing the reliability of the power supplied to the customers connected to a distribution system, as well as to minimize the real power loss in the system. To evaluate the reliability at various load points, probabilistic reliability models of various components are considered. The first step in evaluating the reliability at the load points is the determination of the minimal cut sets of components between the source and the load.

### A. Finding the Minimal Cut Sets

The minimal cut set method is used to find the minimal number of components, the outage of any of which will render the corresponding load point out of power. The algorithm for finding the minimal cut sets described in [23] is used in this paper. A complete description of this algorithm is out of scope of this paper. Important features of the algorithm are that: 1) only one set of topological input data is required to evaluate the minimal cut sets for every load point; 2) a mix of unidirectional,

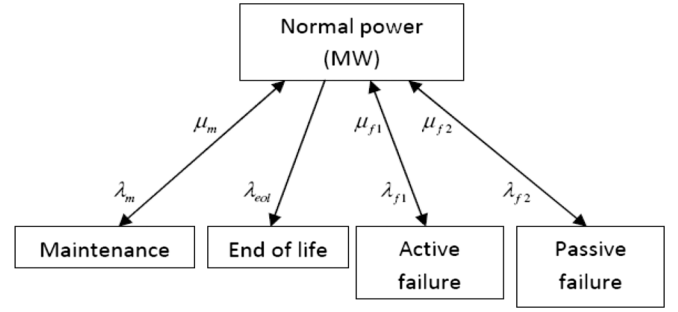

Fig. 1. Reliability model for the generator, transformer, and circuit breaker.

bidirectional, and multiended components can be included; and 3) any number of input nodes may be specified. It takes the system data as input; then for each load point, it prepares the network topology. Minimal paths are then deduced, followed by the determination of the associated minimal cut sets for the load point.

### B. Component Reliability Models

Probabilistic reliability models of various components appearing in the minimal cut sets are developed based on their outage history and commissioning details. The availability of a component may be defined as [2]

$$P = \frac{\text{MTTF}}{\text{MTTF} + \text{MTTR}} = \frac{\sum_i 1/\lambda_i}{\sum_i 1/\lambda_i + \sum_i 1/\mu_i} \quad (1)$$

where MTTF is the mean time to failure, and MTTR is the mean time to repair for a component;  $\lambda_i$  and  $\mu_i$  are different types of outage and repair rates considered. The types of outage and repair rates considered in this paper are defined as follows:

- $\lambda_f, \mu_f$  failure and recovery rate of a component;
- $\lambda_m, \mu_m$  maintenance and recovery rate of a component;
- $\lambda_{eol}$  end-of-life rate of a component.

*Generator, Transformer, and Circuit-Breaker (CB) Model:* The common model for the generator, transformer, and CB is shown in Fig. 1. It includes two failure modes, which are: 1) active and 2) passive. A passive event is a component failure mode that does not cause the operation of protection breakers and, therefore, does not have an impact on the remaining healthy components. Service is restored by repairing or replacing the failed component. Examples are open circuits and inadvertent opening of breakers. An active event is a component failure mode that causes the operation of the primary protection zone around the failed component and can therefore cause the removal of other healthy components and branches from service. Maintenance outage and end-of-life probabilities are also included in the model.

*Bus Model:* The reliability model of a busbar is shown in Fig. 2, which includes maintenance and failure modes.

*Distribution Line and Switch Model:* The reliability model of the transmission line and switch is shown in Fig. 3, which

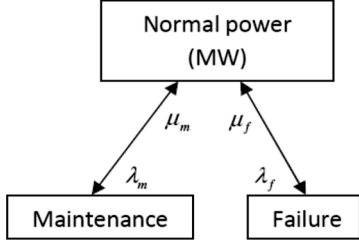

Fig. 2. Reliability model for a bus.

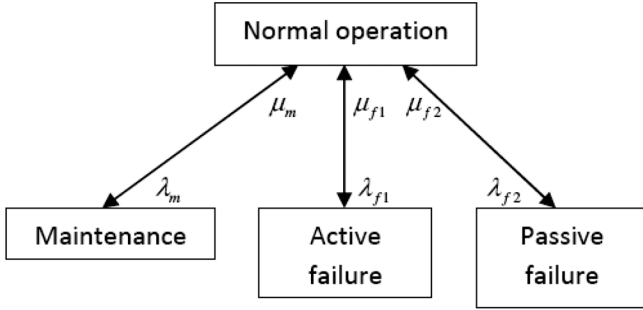

Fig. 3. Reliability model for the transmission line and switch.

includes active and passive failure modes, and a maintenance outage state.

### C. Evaluating the Reliability at the Load Centers

Monte Carlo simulation has been the most commonly used technique for probabilistic reliability evaluation methods [24]. However, this method is time-consuming and may not be suitable for applications in large power systems. The computational time can be prohibitively large even for an offline planning stage. One major contribution of this paper is the application of the probabilistic method with very less computational time even for large systems. It has been identified in this paper that the number of components appearing between the feeder and a load point in a distribution system is limited. Hence, the computation of the joint probability of outage of the components is possible within a short time, as explained in the following text.

The minimal cut sets between the feeder and the load points are determined by using the algorithm referred to in Section II-A. For the power failure at a load point, all of the components of a cut set must fail. Consequently, the components of a second or higher order cut set are effectively connected in parallel and the unavailability of a cut set is the product of unavailability of components in that cut set, assuming the failure events of the components are to be independent of each other. In addition, the load point fails if failure of any one of the cut sets occurs, and consequently, each cut set is effectively connected in series with all other cut sets. The details of evaluating the reliability at the load points for cut sets of different orders are described in the following text. The unreliability at the load point is given by

$$Q = P\left(\bigcup_i C_i\right) \quad (2)$$

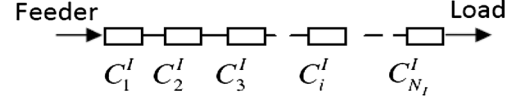

Fig. 4. First-order cut sets between the feeder and the load.

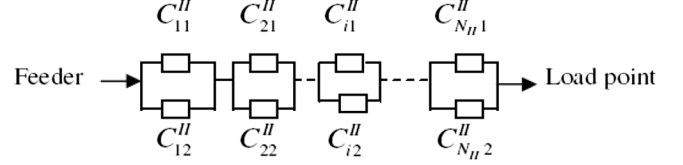

Fig. 5. Second-order cut sets between the feeder and the load.

where  $C_i$  is the failure event of the  $i$ th minimal cut set between the feeder and the load point, and  $P(\cdot)$  denotes the probability of occurrence of an event.

The corresponding reliability at the load point is given by

$$R = 1 - Q. \quad (3)$$

*First-Order Cut Sets:* Fig. 4 shows a set of first-order cut sets between the feeder and the load point. The failure event of the  $i$ th first-order cut set is denoted by  $C_i^I$ ; and  $N_I$  is the total number of first-order cut sets.

The unreliability at the load point due to outage of elements belonging to one or more first-order cut sets is given by

$$\begin{aligned} Q^I &= P\left(\bigcup_{i=1}^{N_I} C_i^I\right) \\ &= \sum_{i=1}^{N_I} P(C_i^I) - \sum_{i=1}^{N_I} \sum_{j=i+1}^{N_I} P(C_i^I \cap C_j^I) + \dots \\ &\quad + (-1)^{(N_I+1)} P(C_1^I \cap C_2^I \cap \dots \cap C_{N_I}^I). \end{aligned} \quad (4)$$

*Second-Order Cut Sets:* Fig. 5 shows a number of second-order cut sets between the feeder and the load point. The power failure at a load point due to the failure of a second-order cut set occurs when both components in the cut set fail, since they are connected in parallel. The unreliability of the load point due to outage of components belonging to one or more second-order cut sets is given by

$$Q^{II} = P(C^{II}) \quad (5)$$

where the failure event  $C^{II}$  is given by

$$C^{II} = \bigcup_{i=1}^{N_{II}} C_i^{II}. \quad (6)$$

Here,  $N_{II}$  is the total number of second-order cut sets. A second-order cut set can cause a failure only when both of its components fail. Hence

$$C_i^{II} = C_{i1}^{II} \cap C_{i2}^{II} \quad (7)$$

where  $C_{i1}^{II}$  and  $C_{i2}^{II}$  are the failure events of components belonging to the  $i$ th second-order cut set.

Similar to the previous discussion, one can calculate the unreliability at the load point for third and higher order cut sets.

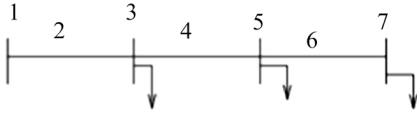

Fig. 6. Single-line diagram of a simple distribution feeder.

 TABLE I  
 MINIMAL CUT SETS AND UNRELIABILITY AT THE LOAD POINTS FOR THE  
 SIMPLE THREE-BUS SYSTEM

Output node	Minimal cut sets	unreliability
3	1, 2, 3	3.11e-4
5	1, 2, 3, 4, 5	5.18e-4
7	1, 2, 3, 4, 5, 6, 7	7.26e-4
Average system unreliability		5.18e-4

Once the unreliability is computed for various orders of cut sets, (2) can be used to compute the total unreliability at the load point. The corresponding measure of the reliability is obtained by using (3). For a distribution system having multiple load points, the average value of the unreliability is taken as

$$Q_{SA} = \frac{1}{L} \sum_{i=1}^L Q_{i(\text{load}\{\text{point}\})} \quad (8)$$

where  $Q_{SA}$  is the average unreliability for the system, and  $L$  is the total number of load points considered in the distribution system.

The proposed methodology is explained with the help of a three-bus system shown in Fig. 6. The feeder (input) is connected to bus 1. Loads (outputs) are connected at buses 3, 5, and 7. All components are assumed to have identical reliability data as will be given. Both bus and line are assumed to have the model depicted in Fig. 2 for simplification

Failure rate = 0.02 outages/year;

Repair time = 30 h;

Maintenance rate = 0.2 outages/year;

Maintenance time = 20 h.

Using the reliability models discussed earlier, the availability and the unavailability of each component are computed as

Availability = 0.999896;

Unavailability =  $1.037667e - 4$ .

Applying the probabilistic reliability evaluation method discussed in this section, the minimal cut sets and unreliability of each output node are computed, as shown in Table I. For example, power supply to the load at bus 3 is lost in the event of failure of bus 1, line 2, or bus 3; and the corresponding unreliability evaluated at the load point 3 is  $3.1127e-4$ . Each bus and line are considered as separate components.

### III. DISTRIBUTION SYSTEM POWER-LOSS ASSESSMENT

The distribution system power loss for each configuration is calculated using a distribution system load flow. The algorithm for calculating the system loss described in [25] is used in this paper. Suitable modifications are implemented in the

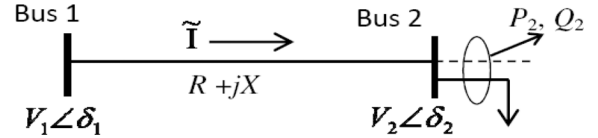

Fig. 7. Simple two-bus distribution system [24].

algorithm to take into account the fact that the system topology changes with each reconfiguration, requiring reassignment of the sending-end and receiving-end node numbers for each branch. The calculation of the power loss can be explained with the help of a simple two-bus system shown in Fig. 7.

The voltage phasors at buses 1 and 2 are given by  $V_1 \angle \delta_1$  and  $V_2 \angle \delta_2$ , respectively. The current from bus 1 to bus 2 (neglecting the shunt flow) is given by

$$\tilde{I} = (V_1 \angle \delta_1 - V_2 \angle \delta_2) / (R + jX). \quad (9)$$

The load power consumption (power flowing through bus 2) is given by

$$P_2 - jQ_2 = \tilde{V}_2^* \tilde{I}. \quad (10)$$

From (9) and (10), one can have

$$V_2 = \left[ \left\{ (P_2 R + Q_2 X - 0.5 V_1^2)^2 - (R^2 + X^2) (P_2^2 + Q_2^2) \right\}^{1/2} - (P_2 R + Q_2 X - 0.5 V_1^2) \right]^{1/2} \quad (11)$$

where  $P_2$  and  $Q_2$  are total real and reactive power loads fed through node 2.

The real power loss in the branch is therefore given by

$$P_{loss} = R (P_2^2 + Q_2^2) / V_2^2. \quad (12)$$

The real power loss in all branches can be evaluated in the same manner. The system real power loss is taken to be the sum of the real power loss in all branches.

### IV. DISTRIBUTION SYSTEM RECONFIGURATION

The reconfiguration of the distribution system discussed in this paper is aimed at maximizing the reliability of the power at the load points and minimizing the system power loss. A BPSO-based algorithm is used to find the optimal configuration of the switches in the network. At each iteration, reliability at the load points is evaluated by using the probabilistic method described in Section II, and the system power loss is computed by using the method discussed in Section III. A brief discussion regarding the BPSO algorithm is presented in the following section [26], followed by the description of the reconfiguration problem.

#### A. Binary Particle Swarm Optimization (BPSO)

The switches in the distribution system reconfiguration problem can remain only in two states: open or close. Assigning a value of 1 to the ‘‘close’’ state, and 0 to the ‘‘open’’ state, the switch status can be described by a binary vector. BPSO is an algorithm that searches for such binary vectors as the solution of a problem and, therefore, is found to be suitable

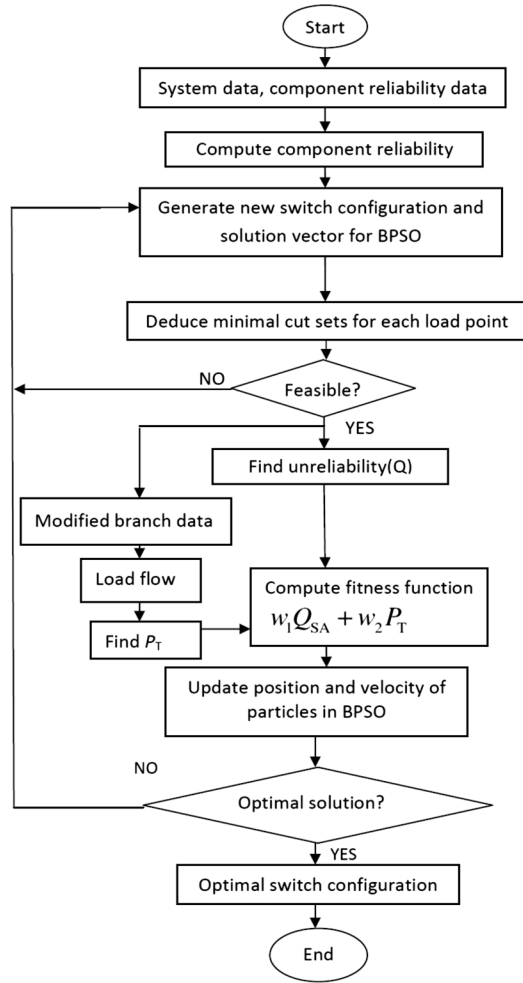

Fig. 8. Flowchart for the reconfiguration of power distribution systems.

for the present case. To find the optimal solution of the problem, a number of particles are employed. The movement of particles toward finding the optimal solution is guided by the knowledge of individual and other particles. The position of particle at any instant is determined by its velocity at that instant and the position at the previous instant, as shown

$$\mathbf{x}_i(t) = \mathbf{x}_i(t-1) + \mathbf{v}_i(t) \quad (13)$$

where  $\mathbf{x}_i(t)$  and  $\mathbf{x}_i(t-1)$  are the position vectors of the  $i$ th particles at the instants  $t$  and  $t-1$ , respectively, and  $\mathbf{v}_i(t)$  is the velocity vector of the particles.

The velocity of each particle is updated using the experience of individual particles as well as the knowledge of the performance of the other particles in its neighborhood

$$\mathbf{v}_i(t) = \mathbf{v}_i(t-1) + \varphi_1 \cdot r_1 \cdot (\mathbf{pbest}_i - \mathbf{x}_i(t-1)) + \varphi_2 \cdot r_2 \cdot (\mathbf{gbest} - \mathbf{x}_i(t-1)) \quad (14)$$

where  $\varphi_1$  and  $\varphi_2$  are adjustable parameters, called individual and social acceleration constants, respectively;  $r_1$  and  $r_2$  are random numbers in the range  $[0, 1]$ ;  $\mathbf{pbest}_i$  is the best position vector found by the  $i$ th particle;  $\mathbf{gbest}$  is the best among the position vectors found by all of the particles.

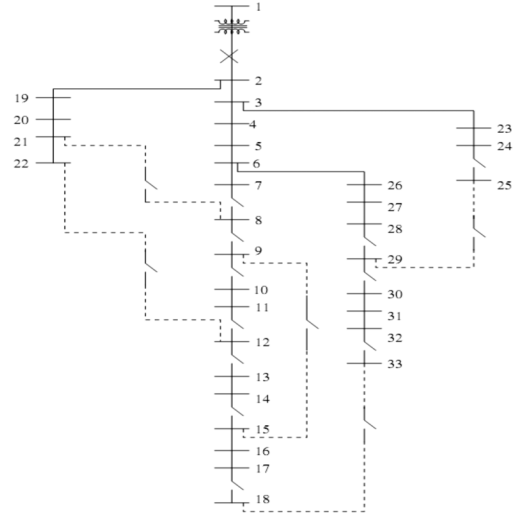

Fig. 9. Modified 33-bus radial distribution system [25].

TABLE II  
COMPONENT RELIABILITY DATA

Component	$\lambda_{f1}$	$\lambda_{f2}$	$r_{f1}$	$r_{f2}$	$\lambda_m$	$r_m$	$\lambda_{eol}$
Transformer	0.05882	0.05555	144	144	1	168	0.001
Circuit breaker	0.1	0.142857	20	20	0.4	12	0.001
Bus-bar	0.0045	-	24	-	0.5	4	-
Distribution line	0.13	0.13	5	5	0.2	2	-
switch	0.2	0.2	5	5	0.25	4	-

TABLE III  
BPSO PARAMETERS

Parameter	Optimal value
Number of particles	100 x No. of switches
Individual acceleration constant( $\Phi_1$ )	2
Social acceleration constant( $\Phi_2$ )	2
Number of iterations after which the search is stopped if no better solution is found	5
Maximum number of iterations	10 x No. of switches

The vectors  $\mathbf{pbest}_i$  and  $\mathbf{gbest}$  are evaluated by using a suitably defined fitness function.  $\varphi_1$  and  $\varphi_2$  are usually defined so that  $\varphi_1 + \varphi_2 = 4$ , with  $\varphi_1 = \varphi_2 = 2$ . The maximum and minimum value of the elements of the velocity vector are defined as

$$v_{ij} = \begin{cases} -v_{\max}, & \text{if } v_{ij} < -v_{\max} \\ v_{\max}, & \text{if } v_{ij} > v_{\max}. \end{cases} \quad (15)$$

Each element in the position vector can take only binary values (i.e., 1 or 0). At each stage of iteration, the elements of the position vector  $\mathbf{x}_i$  are updated according to the following rule:

$$x_{ij}(t) = \begin{cases} 1, & \text{if } \rho_{ij} < s(v_{ij}) \\ 0, & \text{otherwise} \end{cases} \quad (16)$$

where  $\rho_{ij}$  is a random number in the range  $[0, 1]$ , and  $s(v_{ij})$  is a sigmoidal function defined as

$$s(v_{ij}) = \frac{1}{1 + \exp(-v_{ij})}. \quad (17)$$

TABLE IV  
OPTIMAL SOLUTION FOR 33-BUS TEST SYSTEM

Item	Base case	Reconfiguration for maximum reliability	Reconfiguration for minimum loss	Reconfiguration for minimum loss and maximum reliability $w_1=1000, w_2=1$	Reconfiguration for minimum loss and maximum reliability $w_1=10000, w_2=1$
Open switch between buses (sending end-receiving end)	8-21, 9-15, 12-22, 18-33, 25-29	7-8, 9-10, 14-15, 24-25, 18-33	7-8, 9-10, 14-15, 32-33, 25-29	7-8, 9-10, 14-15, 32-33, 25-29	7-8, 9-10, 14-15, 18-33, 25-29
Unreliability	0.001815	0.001113	0.001125	0.001125	0.001122
Down time (hours/year)	15.90	9.75	9.85	9.85	9.83
Energy not supplied (kwhr)	29,536.16	18,114.75	18,306.199	18,306.199	18,272.99
Loss (kw)	210.98	179.32	139.55	139.55	142.19
Energy loss per year (kwhr)	693092.295	589076.05	458434.89	458434.89	467021.88

**B. Formulation of the Reconfiguration Problem**

In this paper, the performance criteria of the distribution system reconfiguration method are the system reliability and the system power loss. The BPSO algorithm searches for the optimal status of switches to maximize the average reliability at the load points and minimize the system power loss.

In the BPSO, the position vectors of the particles represent the switch status for the distribution system reconfiguration problem. The constraint imposed on each position vector for the feasibility of a set of switch configuration is that the electrical connection from source to the load should be maintained. A fitness function needs to be defined to evaluate the suitability of the solutions found by the particles at each stage of the iteration. The individual best position vector of a particle  $\mathbf{pbest}_i$ , and the global best position vector  $\mathbf{gbest}$  are evaluated based on this fitness function. The goal here is to minimize the unreliability of the power supplied to the customers and to minimize the system power loss. For each particle, first, it checks for feasibility of the switch configuration, if it is feasible, it finds the system unreliability and system power loss.

The fitness function  $J(\mathbf{x})$  for using the BPSO is formulated as follows:

$$J(\mathbf{x}) = \begin{cases} K, & \text{if the configuration is not feasible} \\ w_1 Q_{SA} + w_2 P_T, & \text{if the configuration is feasible} \end{cases} \quad (18)$$

where  $P_T$  is the total real power loss in the distribution system,  $K$  is a large number assigned to the fitness function if the position vector representing the set of switch configurations is not feasible, and  $w_1$  and  $w_2$  are the weights assigned to the parts of the fitness function. The relative importance of the load-point reliability and the system power loss can be changed by varying the weights.

The number of elements in the binary position vector  $\mathbf{x}$  is equal to the number of switches in the system. The elements of  $\mathbf{x}$  are defined as follows:

$$x = \begin{cases} 1, & \text{if the switch is closed} \\ 0, & \text{if the switch is open.} \end{cases} \quad (19)$$

The BPSO algorithm starts with a randomly selected binary position vector  $\mathbf{x}$  (i.e., each element is randomly assigned a value of either 0 or 1). For simplified analysis, maintaining the radiality of the connection between a load point and the feeder is taken as a necessary constraint. If the switch configuration fails to connect the load to the source, or to maintain the radiality of

the network, it is considered an infeasible solution, and a large number  $K$  is assigned to the fitness function. If the switch configuration is feasible, the average system unreliability and the total power loss are evaluated. The overall procedure is shown in the flowchart in Fig. 8.

V. CASE STUDIES

The proposed methodology of distribution system reconfiguration for maximizing the reliability at the load points and minimizing the system power loss is first applied on the modified 33-bus radial distribution system shown in Fig. 9 [27]. All of the buses, except the substation bus, are treated as load points. The line data and load data of this system are given in [27]. The possible locations of switches are shown in Fig. 9. Each switch can be either open or close. The optimal status (open or close) of the switches is determined by using BPSO-based search method. For simplified analysis, it is assumed in this paper that the reconfigured system should be radial, which is generally true for low-voltage distribution systems. Since the radiality of the system is taken as a necessary constraint, only first-order cut sets need to be taken into consideration while evaluating the reliability at any load point.

Typical values of failure and maintenance rates are assumed for various components [22]. Table II shows the reliability data for each component. For a bus, the failure rate  $\lambda_{f1}$  in Table II corresponds to  $\lambda_f$  in Fig. 2. Instead of recovery rates, the corresponding repair times in hours are shown in Table II as  $r_{f1}$ ,  $r_{f2}$ , and  $r_m$ .

The reliability data given in Table II are used to formulate the probabilistic reliability models of the components, as shown in (1). Table III shows the chosen values of the parameters for the BPSO. These values are chosen after multiple runs of the algorithm, and offer best performance in terms of finding the optimal switch configuration and computational time.

For better visualization of the case studies, the unreliability at the load points is converted into energy not supplied (ENS) per year and the loss is converted into energy loss per year [28]. A sample calculation is shown as follows.

Let the connected maximum load be 3715 kW. Assuming a load factor  $F = 0.5$  and demand factor = 1, the loss load factor  $G = (0.5F + 0.5F^2) = 0.375$ . The average load is then given by  $3715 \times F = 1857.5$  kW. The average downtime per year =  $8760 \times Q_{SA}$ . The energy not supplied (ENS) is given by

$$ENS = \text{average load} \times \text{downtime.} \quad (20)$$

TABLE V  
OPTIMAL SOLUTION FOR THE 123-BUS TEST SYSTEM

Item	Reconfiguration for maximum reliability	Reconfiguration for minimum loss	Reconfiguration for maximum reliability and minimum loss, $w_1=1000, w_2=1$
Open switch between buses (sending end-receiving end)	60-67 (SW4), 97-197 (SW6)	54-94 (SW3), 97-197 (SW6)	54-94 (SW3), 97-197 (SW6)
Unreliability	0.001229	0.001242	0.001242
Down time(hours/year)	10.76	10.88	10.88
Energy not supplied(kWhr)	20216.84	20435.46	20435.46
Loss(kW)	32.8188	32.0392	32.0392
Energy loss per year(kWhr)	107809.75	105248.77	105248.77

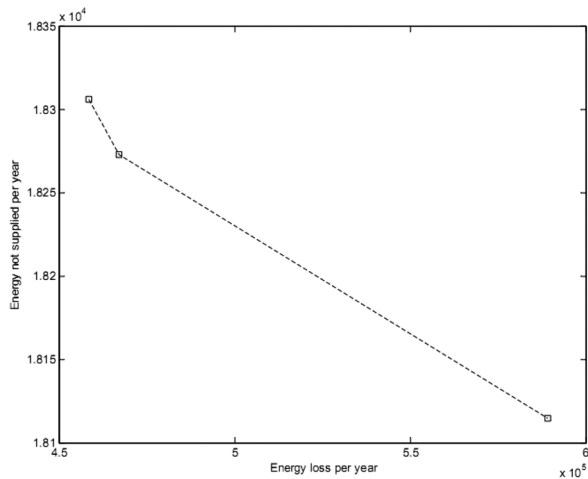

Fig. 10. Pareto front with the objective of minimizing the energy loss and ENS for different configurations of the 33-bus test system.

The energy loss per year ( $P_{Ty}$ ) is given by

$$P_{Ty} = \text{loss} \times 8760 \times \text{loss load factor.} \quad (21)$$

It is to be noted here that it can be possible to include the effect of load variations throughout a day in the aforementioned formulations, if such detailed information is available. Instead of calculating the average load for the whole span of a year, one can use smaller intervals, such as days or even hours, and add the ENS over such intervals to obtain the ENS for a year.

The simulation results for the 33-bus system are shown in Table IV. It shows the results of reconfiguration for maximum reliability, for minimum loss, and for maximum reliability and minimum loss with varying weights. For each switch configuration, the reliability at the load points is found by the probabilistic reliability evaluation method described earlier. The total real power loss in the system is also computed by the method discussed earlier.

A Pareto front [29] is shown in Fig. 10, which is drawn with the objective of minimizing the energy loss and ENS for different configurations. One can choose the desired configuration based on the requirement of maximum reliability or minimum loss or a tradeoff between these two.

The proposed methodology is also applied on the modified IEEE 123-node test feeder shown in Fig. 11 [30]. The test results for the modified IEEE 123-node test feeder are shown in Table V. Due to the limited number of available distribution

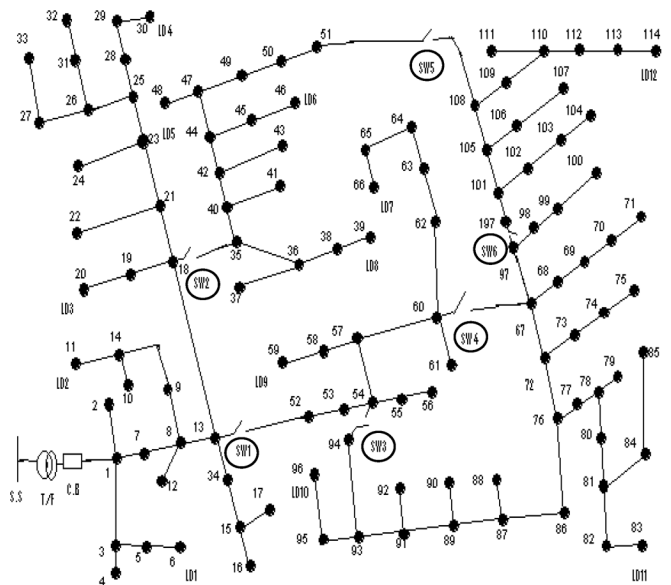

Fig. 11. Modified IEEE 123-node test feeder [26].

paths, there are only two feasible solutions for the reconfiguration problem: one for minimum loss (switch 3 and 6 open, remaining ones closed) and one for maximum reliability (switch 4 and 6 open, remaining ones closed). The solutions in columns 3 and 4 of Table V are identical. The dark circles in Fig. 11 are load points. It may be noted from the optimal switch configurations presented in Table V that each of the load points are connected radially to the feeder after reconfiguration.

It is to be noted that although the results presented in this section correspond to radial distribution systems, the procedure described in Section II is valid for meshed systems as well. Another application of the proposed methodology can be the evaluation of the reliability using probabilistic models for the failure of two or more components, each belonging to separate parallel paths of second-order or higher order cut sets. For example, after a component fails, the load-point power may be restored by an alternative path. Treating the alternative path as the second path of a second-order cut set, unreliability at the load point due to a subsequent failure in the alternate path can be evaluated.

## VI. CONCLUSION

This paper presents a methodology for the reconfiguration of distribution systems in order to maximize the reliability of the

power supplied to the load points and to minimize the system power loss. Formulation of the reconfiguration problem in a multiobjective framework, considering reliability and power loss is one of the contributions of this paper. Typically, the Monte Carlo method is used to work with probabilistic reliability models, which is time-consuming. A major contribution of this paper is to incorporate probabilistic reliability evaluation methods into the distribution system reconfiguration problem, which has generally not been used in the literature due to the large computational time required. The use of the existing methods, such as Monte Carlo simulation, is not feasible even for offline planning studies because of the prohibitively large computational time. In this paper, the minimal cut sets of components appearing between the feeder and load points are determined first by using an algorithm for finding the minimal cut sets for a general network. Probabilistic reliability models of components involved in the cut sets are then used to evaluate the joint probability of the event of power outage at the load points, and subsequently, the reliability at the load points. The distribution system load flow is used to evaluate the system power loss. The reconfiguration of the distribution system is performed by closing or opening a set of switches. A BPSO-based search algorithm is used to determine the optimal status of the switches in the distribution system. The proposed method is successfully applied on a 33-bus and a 123-bus radial distribution system.

## REFERENCES

- [1] Power System Outage Task Force, "Final report on the August 14, 2003 blackout in the United States and Canada: Causes and recommendations, Canada, Apr. 2004.
- [2] R. Billinton and R. N. Allan, *Reliability Evaluation of Power Systems*, 2nd ed. New York: Plenum, 1996.
- [3] H. L. Willis, *Power Distribution Planning Reference Book*, 2nd ed. New York: Marcel Dekker, 2004.
- [4] M. E. Baran and F. F. Wu, "Network reconfiguration in distribution systems for loss reduction and load balancing," *IEEE Trans. Power Del.*, vol. 4, no. 2, pp. 1401–1407, Apr. 1989.
- [5] S. K. Goswami and S. K. Basu, "A new algorithm for the reconfiguration of distribution feeders for loss minimization," *IEEE Trans. Power Del.*, vol. 7, no. 3, pp. 1484–1491, Jul. 1992.
- [6] A. B. Morton and I. M. Y. Mareels, "An efficient brute-force solution to the network reconfiguration problem," *IEEE Trans. Power Del.*, vol. 15, no. 3, pp. 996–1000, Jul. 2000.
- [7] M. A. Kashem, G. B. Jasmon, and V. Ganapathy, "A new approach of distribution system reconfiguration for loss minimization," *Elect. Power Energy Syst.*, vol. 22, no. 4, pp. 269–276, May 2000.
- [8] A. Abur, "A modified linear programming method for distribution system reconfiguration," *Elect. Power Energy Syst.*, vol. 18, no. 7, pp. 469–474, Oct. 1996.
- [9] M. K. K. Nara, A. Shiose, and T. Ishihara, "Implementation of genetic algorithm for distribution systems loss minimum reconfiguration," *IEEE Trans. Power Syst.*, vol. 7, no. 3, pp. 1044–1051, Aug. 1992.
- [10] Y. J. Jeon, J. O. Kim, J. R. Shin, and K. Y. Lee, "An efficient simulated annealing algorithm for network reconfiguration in large-scale distribution systems," *IEEE Trans. Power Del.*, vol. 17, no. 4, pp. 1070–1078, Oct. 2002.
- [11] C. T. Su and C. S. Lee, "Network reconfiguration of distribution systems using improved mixed-integer hybrid differential evolution," *IEEE Trans. Power Del.*, vol. 18, no. 3, pp. 1022–1027, Jul. 2003.
- [12] V. Parada, J. A. Ferland, M. Arias, and K. Daniels, "Optimization of electrical distribution feeders using simulated annealing," *IEEE Trans. Power Del.*, vol. 19, no. 3, pp. 1135–1141, Jul. 2004.
- [13] K. Prasad, R. Ranjan, N. C. Sahoo, and A. Chaturvedi, "Optimal reconfiguration of radial distribution systems using a fuzzy mutated genetic algorithm," *IEEE Trans. Power Del.*, vol. 20, no. 2, pt. 1, pp. 1211–1213, Apr. 2005.
- [14] H. Salazar, R. Gallego, and R. Romero, "Artificial neural networks and clustering techniques applied in the reconfiguration of distribution systems," *IEEE Trans. Power Del.*, vol. 21, no. 3, pp. 1735–1742, Jul. 2006.
- [15] D. Das, "A fuzzy multi objective approach for network reconfiguration of distribution systems," *IEEE Trans. Power Del.*, vol. 21, no. 1, pp. 202–209, Jan. 2006.
- [16] J. S. Savier and D. Das, "Impact of network reconfiguration on loss allocation of radial distribution systems," *IEEE Trans. Power Del.*, vol. 22, no. 4, pp. 2473–2480, Oct. 2007.
- [17] C. S. Chen, C. H. Lin, H. J. Chuang, C. S. Li, M. Y. Huang, and C. W. Huang, "Optimal placement of line switches for distribution automation systems using immune algorithm," *IEEE Trans. Power Syst.*, vol. 21, no. 3, pp. 1209–1217, Aug. 2006.
- [18] A. Moradi and M. F. Firuzabad, "Optimal switch placement in distribution systems using trinary particle swarm optimization algorithm," *IEEE Trans. Power Del.*, vol. 23, no. 1, pp. 271–279, Jan. 2008.
- [19] H. Falaghi, M. R. Haghifam, and C. Singh, "Ant colony optimization-based method for placement of sectionalizing switches in distribution networks using a fuzzy multi objective approach," *IEEE Trans. Power Del.*, vol. 24, no. 1, pp. 268–276, Jan. 2009.
- [20] A. C. Gallardo, L. G. Santander, and J. E. Pezoa, "Greedy reconfiguration algorithm for medium-voltage distribution networks," *IEEE Trans. Power Del.*, vol. 24, no. 1, pp. 328–337, Jan. 2009.
- [21] W. Li, P. Wang, Z. Li, and Y. Liu, "Reliability evaluation of complex radial distribution systems considering restoration sequence and network constraints," *IEEE Trans. Power Del.*, vol. 19, no. 2, pp. 753–758, Apr. 2004.
- [22] Risk A. Manitoba HVDC Research Centre, Winnipeg, MB, Canada, Oct. 2002.
- [23] R. N. Allan, R. Billinton, and M. F. De oliveira, "An efficient algorithm for deducing the minimal cuts and reliability indices of a general network configuration," *IEEE Trans. Rel.*, vol. R-25, no. 4, pp. 226–233, Oct. 1976.
- [24] R. Billinton and W. Li, *Reliability Assessment of Electric Power Systems Using Monte Carlo Methods*. New York: Plenum, 1994.
- [25] D. Das, D. P. Kothari, and A. Kalam, "Simple and efficient method for load flow solution of radial distribution networks," *Elect. Power Energy Syst.*, vol. 17, no. 5, pp. 335–346, Oct. 1995.
- [26] Y. Del Valle, G. K. Venayagamoorthy, S. Mohagheghi, J. C. Hernandez, and R. G. Harley, "Particle swarm optimization: Basic concepts, variants and applications in power systems," *IEEE Trans. Evol. Comput.*, vol. 21, no. 2, pp. 171–195, Apr. 2008.
- [27] B. Venkatesh and R. Rajan, "Optimal radial distribution system reconfiguration using fuzzy adaptation of evolutionary programming," *Elect. Power Energy Syst.*, vol. 25, no. 10, pp. 775–780, Dec. 2003.
- [28] C. L. Wadhwa, *Generation, Distribution and Utilization of Electrical Energy*. New Delhi, India: New Age Int. Publishers, 1993, Revised Ed.
- [29] P. Ngatchou, A. Zarei, and M. A. El-Sharkawi, "Pareto multi objective optimization," in *Proc. 13th Int. Conf. Intell. Syst. App. Power Syst.*, VA, Nov. 2005, pp. 84–91.
- [30] Distribution System Analysis Subcommittee, "IEEE 123 node test feeder" 2010, Power Energy Soc.



**B. Amanulla** (S'11) received the M.Tech. degree in electrical engineering from the Indian Institute of Technology, Kanpur, India, in 2011.

Currently, he is a Senior Engineer in the Advanced Engineering Group, Ashok Leyland Technical Center. His research interests are in power system reliability and hybrid electric vehicles.



**Saikat Chakrabarti** (S'06-M'07-SM'11) received the Ph.D. degree from Memorial University of Newfoundland, St. John's, NF, Canada.

Currently, he is an Assistant Professor in the Department of Electrical Engineering, Indian Institute of Technology, Kanpur, India. His research interests include power system dynamics and stability, state estimation, reliability, and synchrophasor applications to power systems.





**S. N. Singh** (SM'02) received the M.Tech. and Ph.D. degrees from the Indian Institute of Technology, Kanpur, Kanpur, India, in 1989 and 1995, respectively.

Currently, he is an Associate Professor in the Department of Electrical Engineering, Indian Institute of Technology, Kanpur. His research interests include power system restructuring, power system optimization and control, voltage security and stability analysis, power system planning, and artificial-neural-network applications to power system

problems.

Dr. Singh is a Fellow of The Institution of Engineers (IE) India and the The Institution of Electronics and Telecommunication Engineers (IETE) India, and the Institute of Engineering and Technology (U.K.).