

Optimal sizing of a stand-alone hybrid power system via particle swarm optimization for Kahnouj area in south-east of Iran

S.M. Hakimi*, S.M. Moghaddas-Tafreshi**

K.N. Toosi University, Department of Power Engineering, Seyed Khandan, Tehran, P.O. Box. 16315-1355, Iran

ARTICLE INFO

Article history:

Received 7 November 2007

Accepted 14 November 2008

Available online 30 December 2008

Keywords:

Wind turbine

Fuel cell

Hybrid power system

Renewable energy

Optimal sizing

Particle swarm optimization

ABSTRACT

In this paper a novel intelligent method is applied to the problem of sizing in a hybrid power system such that the demand of residential area is met. This study is performed for Kahnouj area in south-east Iran. It is to mention that there are many similar regions around the world with this typical situation that can be expanded. The system consists of fuel cells, some wind units, some electrolyzers, a reformer, an anaerobic reactor and some hydrogen tanks. The system is assumed to be stand-alone and uses the biomass as an available energy resource. In this system, the hydrogen produced by the reformer is delivered to the fuel cell directly. When the power produced by the wind turbine plus power produced by the fuel cell (fed by the reformer) are more than the demand, the remainder is delivered to the electrolyzer. In contrast, when the power produced by the wind turbine plus that produced by the fuel cell (fed by the reformer) are less than the demand, some more fuel cells are employed and they are fed by the stored hydrogen. Our aim is to minimize the total costs of the system such that the demand is met. PSO algorithm is used for optimal sizing of system's components.

© 2008 Elsevier Ltd. All rights reserved.

1. Introduction

The major application of the stand-alone power system is in remote areas where utility lines are uneconomical to install due to terrain, the right-of-way difficulties or the environmental concerns. According to the World Bank, more than 2 billion people live in villages that are not yet connected to utility lines [1]. These villages are the largest potential market of the hybrid stand-alone system using fuel cell with wind for meeting their energy needs.

In previous studies, the optimal sizing problem is solved for wind-fuel cell hybrid system [2], and for wind-solar-fuel cell hybrid system [3]. Furthermore the optimal sizing of wind-solar-battery hybrid system is performed by means of genetic algorithms [4], in these studies optimal sizing of hybrid power system using genetic algorithm [5] and optimal sizing of grid connected hybrid power system [6] were investigated. In this paper, the optimal sizing of a wind-fuel cell hybrid system is considered. The system uses the biomass to produce its required hydrogen.

The optimization is carried out via Particle Swarm Optimization (PSO) algorithm.

Generation of hydrogen by the reformer causes a higher reliability for the system.

In this paper we first consider the hybrid power system and then the cost of the system presented by an objective function. Then we review PSO algorithm and finally some simulation results are presented. This study is performed for Kahnouj site in south-east Iran. It is located in a village with a population of 2000. The waste is used to produce hydrogen. This village is far from the grid.

2. Description of the hybrid system components

2.1. Wind turbine

The outlet energy of a turbine could calculate from its power-speed curve. Such a curve is illustrated in Fig. 1 [4].

The power of the wind turbine is described in terms of the wind speed by Ref. [7],

$$\begin{cases} 0 & V < V_{\text{cut-in}}, V > V_{\text{cut-off}} \\ P_{\text{wg-max}} \times \left(\frac{V - V_{\text{cut-in}}}{V_{\text{rated}} - V_{\text{cut-in}}} \right)^3 & V_{\text{cut-in}} \leq V < V_{\text{rated}} \\ P_{\text{wg-max}} \times \frac{P_{\text{furl}} - P_{\text{rated}}}{V_{\text{cut-off}} - V_{\text{rated}}} \times (V - V_{\text{rated}}) & V_{\text{rated}} \leq V \leq V_{\text{cut-off}} \end{cases} \quad (1)$$

In which $V_{\text{cut-in}}$, cut-in wind speed [m/s]; $V_{\text{cut-off}}$, cut-out wind speed [m/s]; V wind speed [m/s]; V_{rated} nominal wind speed [m/s]; $P_{\text{WG-max}}$, maximum power of wind turbine [kw]; and P_{furl} power of

* Corresponding author. Tel.: +98 9124798639; fax: +98 2188462066.

** Corresponding author.

E-mail addresses: sm_hakimi@yahoo.com (S.M. Hakimi), tafreshi@eedt.kntu.ac.ir (S.M. Moghaddas-Tafreshi).

Nomenclature

P_{wg_conv}	Power delivered from wind turbines to converter (kw)
P_{wg_el}	Power delivered from wind turbines to electrolyzer (kw)
P_{el_tank}	Power delivered from electrolyzer to hydrogen tank (kw)
P_{tank_fc}	Power delivered from hydrogen tank to fuel cell (kw)
P_{fc_conv}	Power delivered from fuel cell to converter (kw)
P_{conv_load}	Power delivered from converter to load(kw)
P_{ref_fc}	Power delivered from reformer to fuel cell (kw)
P_{comp_tank}	Power delivered from compressor to hydrogen tank(kw)
P_{wt}	Power generated by wind turbines(kw)
P_{load}	Load power(kw)
E_{tank}	Stored energy in the hydrogen tank(kwh)
$\eta_{fc}, \eta_{el}, \eta_{conv}$	Efficiency of fuel cell, electrolyzer, converter
NPC_{index}	Net present cost (the index shows the corresponding component)
K	Single-payment present worth factor
R	Lifetime of project (year)
L	Lifetime of each components (year)
Ir	Interest rate
F_{opt}	Optimal cost (\$)
N_{index}	Optimal number (the index shows the corresponding component)

wind turbine in cut out wind speed [kw]. In this analysis, Bergey Wind Power's BWC Excel-R/48 is considered. It has a rated capacity of 7.5 kw and provides 48 V dc as output. Cost of one unit considered is 19.4 \$k while replacement and maintenance cost are taken as 15\$k and \$75/year. Lifetime of a turbine is taken to be 20 years (20a) [7].

2.2. Fuel cell

Proton exchange membrane (PEM) fuel cell is an environmentally clean power generator which combines hydrogen fuel with oxygen from air to produce electricity. The efficiency of the fuel cell is fed to the program as the input. The equivalent heating value of hydrogen is 3.4 kwh/m³ in the standard conditions and its density is around 0.09 kg/m³. Therefore, the amount of energy yielded per kg by hydrogen is

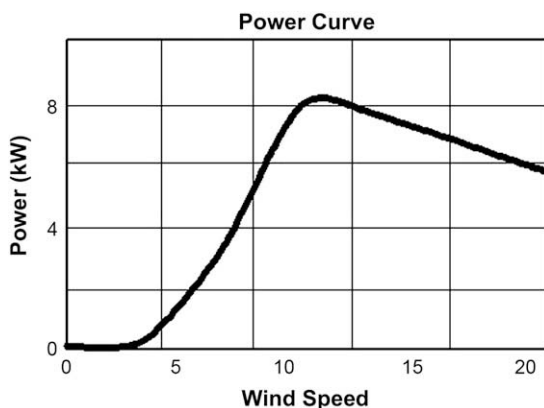

Fig. 1. Wind turbine power versus wind speed characteristic [7].

$$\frac{3.4(\text{kwh/m}^3)}{0.09(\text{kg/m}^3)} = 37.8(\text{kwh/kg}) \quad (2)$$

Therefore,

$$\begin{aligned} &\text{Electricity produced by the fuel cell (kwh)} \\ &= \text{consumed hydrogen(kg)} \times \eta_{fc} \times 37.8 \end{aligned}$$

η_{fc} is the efficiency of the fuel cell.

The capital cost, replacement costs and operational cost are taken as 3\$k, 2.5\$k and \$.02/h for a 1-kw system, respectively. Fuel cell lifetime and efficiency are considered to be 5 years (5a) and 50%, respectively [7].

In this analysis Ballard fuel cell is considered [8].

2.3. Electrolyzer

Electrolysis to dissociate water into its separate hydrogen and oxygen constituents has been in use for decades, primarily to meet industrial chemical needs. Considering an efficiency of 90 percent for the electrolyzer. The amount of energy used to produce 1 kg hydrogen is calculated:

$$\begin{aligned} &\text{Energy consumed by the electrolyzer} \\ &= \left(\frac{3.4(\text{kwh/m}^3)}{0.09(\text{kg/m}^3)/90} \right) \times 100 = 41.97 \text{ kwh/kg} \quad (3) \end{aligned}$$

The weight of hydrogen produced per hour is calculated by dividing the amount of energy flowed from the wind turbine to the 41.97.

$$\text{Hydrogen produced (kg)} = \frac{1 \times P_{wg_el}(\text{kwh})}{41.97(\text{kwh/kg})} \quad (4)$$

In this analysis Avalence electrolyzer is considered [9].

In this analysis, a 1-kw system is associated with 2\$k capital, 1.5\$k replacement and \$20/year maintenance cost and efficiency considered as 90% [7].

2.4. Anaerobic reactor

Anaerobic reactor is a natural process that takes place in the absence of oxygen. The anaerobic reactor provides efficient two-stage digestion of wet biomass. Fig. 2 illustrates this process [10].

The municipal waste is gathered daily and fed to the anaerobic reactor to produce methane.

2.5. Reformer

Hydrogen can be produced from methane using high temperature steam. This process is called steam methane reforming [25]. In this study, MAHLER reformer is considered [11].

It is assumed that the residential area has a population of 2000, and each person produced 600 g waste per day. The hydrogen produced by the waste is constant per day. Furthermore, the hydrogen produced by the waste is 50 kg which equivalent to 1890 kwh.

In this study, anaerobic reactor and reformer are considered as one system. Such that, the waste and hydrogen are its input and output respectively. The relation between the weight of waste and the weight of resultant hydrogen is as follows:

$$H_2(\text{kg}) = 0.0454(\text{waste}(\text{kg})) \quad (5)$$

The capital, replacement and O&M costs for 1 kg hydrogen per day are 1.45\$k, 1.3\$k and \$100 respectively. The lifetime of reformer and anaerobic reactor are 20 years (20a).

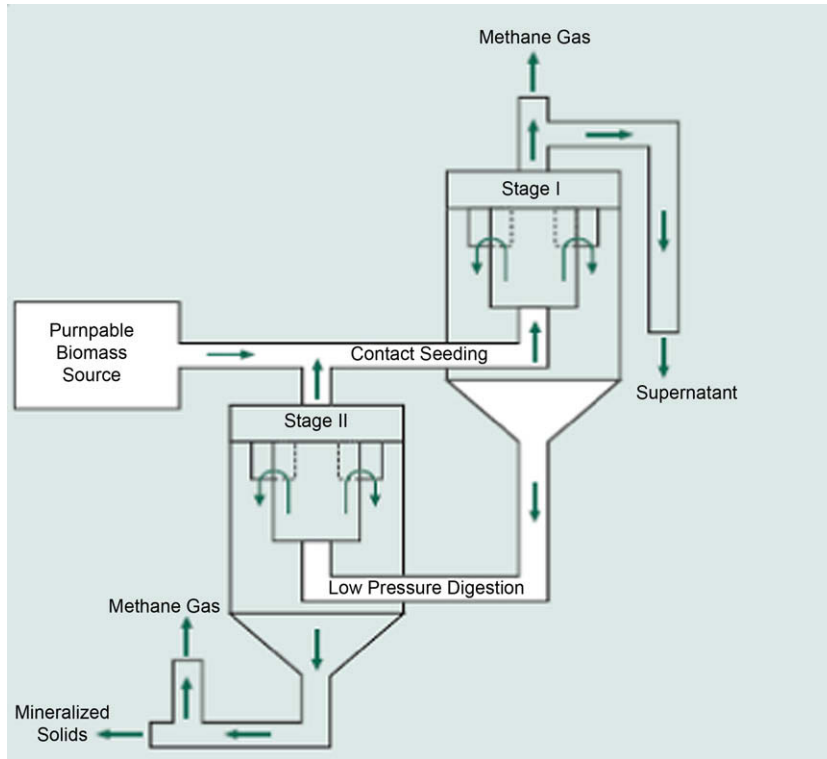

Fig. 2. Anaerobic reactor.

2.6. Hydrogen tank

Primarily, there are three different methods with variable characteristics for hydrogen storage: metal hydrides, liquefaction and high-pressure compression [12].

In this study, we use CH₂ depending on the size of the application.

Cost of a tank with 1 kg capacity is assumed to be 1.3\$k. The replacement and operational costs are taken as 1.2\$k and \$15/year. The lifetime of a unit is considered to be 20 years (20a) [7].

2.7. Power converter

The power electronic circuit used to convert DC into AC is known as the inverter. The DC input to the inverter can be from any of the following sources:

1. DC output of the variable speed wind power system
2. DC output of the fuel cell power system

For a 1-kw system the installation and replacement costs are taken as \$800 and \$750, respectively. Lifetime of a unit is considered to be 15 years (15a) with an efficiency of 90% [7].

2.8. Description of the hybrid system

The hybrid system consists of some wind turbines, some fuel cells, some electrolyzers, some hydrogen tanks, an anaerobic reactor and a reformer (Fig. 3).

It is desirable that the system meets the demand, the costs are minimized and the components have optimal sizes.

We consider three situations for system: A. generation meets demand B. over generation C. over demand [13].

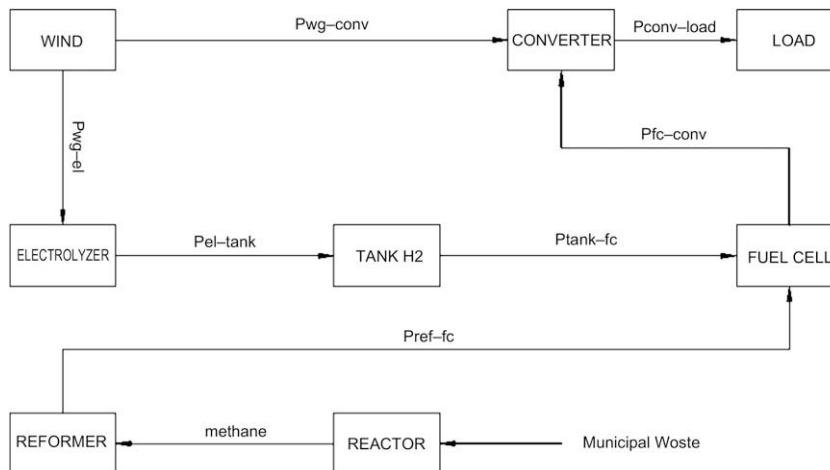

Fig. 3. Schematic diagram of hybrid system.

2.8.1. Generation meets demand

The system configuration Fig. 3 in this situation the power generated by the fuel cell (which is due to the hydrogen produced by the reformer) plus the power produced by the wind turbines is equal to the demand ($P_{wt} + \eta_{fc} \times P_{ref_fc} = (P_{load}/\eta_{conv})$), hence:

$$\begin{aligned} P_{wg_conv} &= P_{wt} \\ P_{wg_el} &= 0 \\ P_{fc_conv} &= \eta_{fc} \times P_{ref_fc} \\ P_{el_tank} &= 0 \\ P_{tank_fc} &= 0 \\ E_{tank(i)} &= E_{tank(i-1)} \end{aligned} \tag{6}$$

It is notable that the time steps are taken to be 1 h in this study.

2.8.2. Over generation

The produced power of the fuel cell (hydrogen produced by reformer) plus the wind turbines power are more than the demand [14].

$$\begin{aligned} P_{wt} + (\eta_{fc} \times P_{ref_fc}) &> (P_{load}/\eta_{conv}) \\ P_{wg_conv} &= (P_{load}/\eta_{conv}) - (\eta_{fc} \times P_{ref_fc}) \\ P_{wg_el} &= P_{wt} - P_{wg_conv} \\ P_{el_tank} &= \eta_{el} \times P_{wg_el} \\ P_{tank_fc} &= 0 \\ P_{fc_conv} &= \eta_{fc} \times P_{ref_fc} \\ E_{tank(i)} &= E_{tank(i-1)} + P_{el_tank(i)} \end{aligned} \tag{7}$$

2.8.3. Over demand

The demand is more than the power generated by the fuel cell (hydrogen produced by reformer) and wind turbines ($P_{wt} + \eta_{fc} \times P_{ref_fc} < (P_{load}/\eta_{conv})$).

Thus the fuel cell is fed by the hydrogen tank.

$$\begin{aligned} P_{wg_conv} &= P_{wt} \\ P_{wg_el} &= 0 \\ P_{el_tank} &= 0 \\ P_{fc_conv} &= (P_{load}/\eta_{conv}) - P_{wg_conv} \\ P_{tank_fc} &= (P_{fc_conv}/\eta_{fc}) - P_{ref_fc} \\ E_{tank(i)} &= E_{tank(i-1)} - P_{tank_fc(i)} \end{aligned} \tag{8}$$

The waste is fed to the anaerobic reactor, daily. The reactor produced a constant volume of methane in each hour. The methane is converted to hydrogen by the reformer, the volume of the produced hydrogen is determined by the produced waste and the size of the anaerobic reactor and the reformer are constant.

2.9. System cost

There are many ways to calculate the economic viability of distribution generation and energy efficiency projects. The capital and replacement costs, the operation and maintenance costs must be combined in some manner so that a comparison may be made with the costs of not doing the project. In this project we don't need fuel cost because of not using fuel.

We choose Net Present Cost (NPC) for calculation of system cost.

2.9.1. Net Present Cost

The Net Present Cost (NPC) of each component is defined as [11]:

$$\begin{aligned} NPC &= N \times \left(\text{capital cost} + \text{replacement cost} \times K \right. \\ &\quad \left. + \text{operation maintenance cost} \times \frac{1}{CRF(ir, R)} \right) \end{aligned}$$

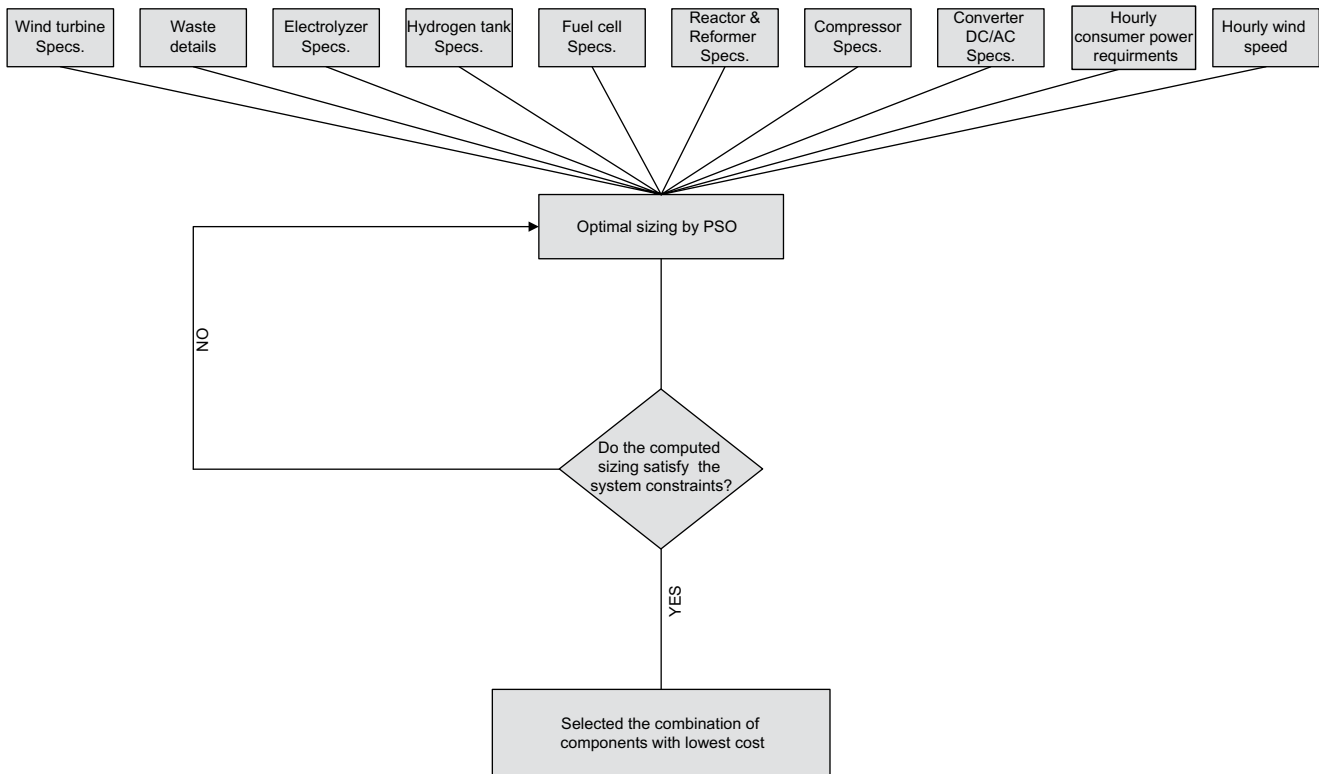

Fig. 4. Flowchart of the proposed optimization methodology.

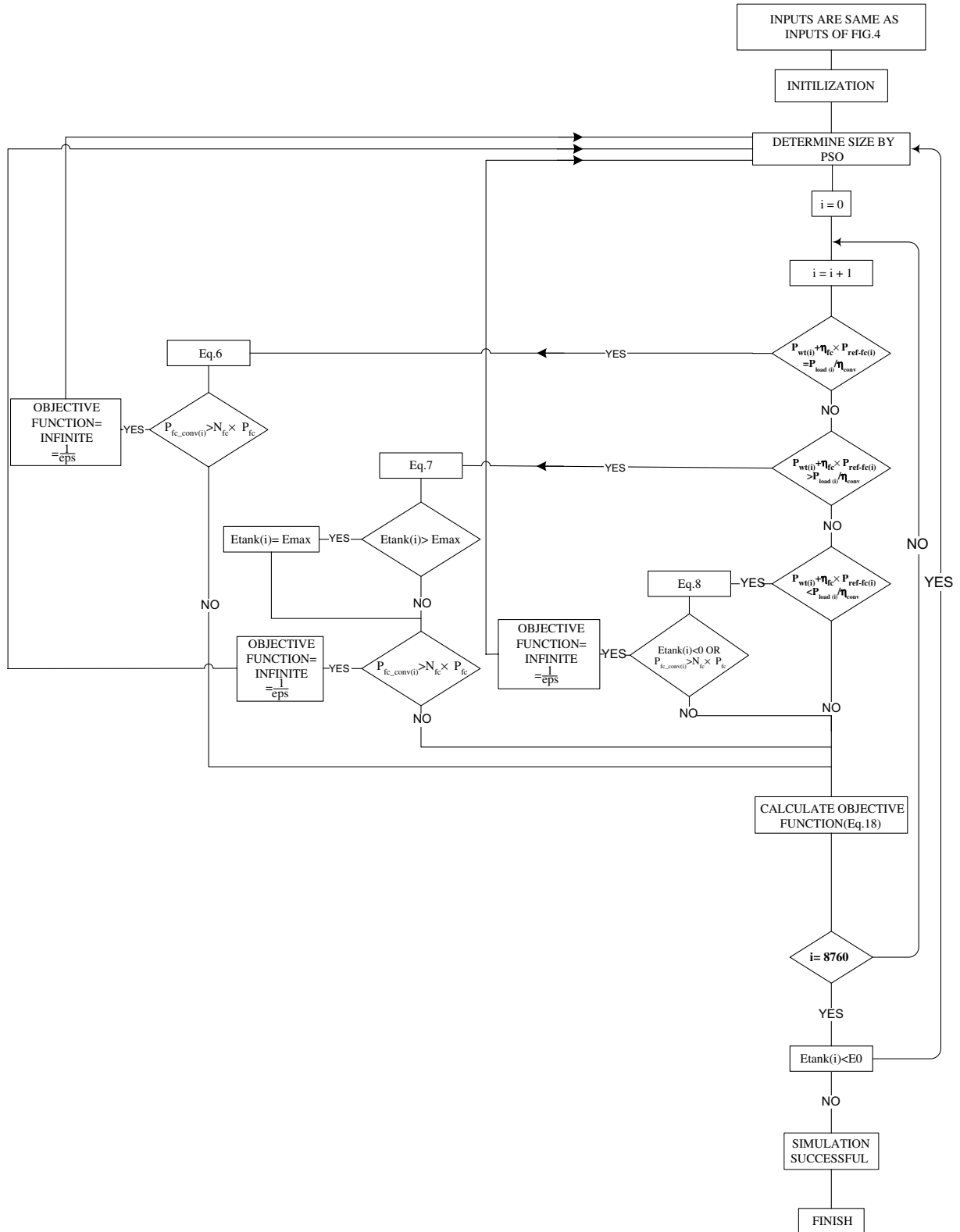

Fig. 5. Flowchart of the algorithm simulating the hybrid system.

$$CRF(ir, R) = \frac{ir(1 + ir)^R}{(1 + ir)^R - 1} \tag{10}$$

$$K = \sum_{n=1}^Y \frac{1}{(1 + ir)^{L \times n}} \tag{11}$$

$$Y = \left\lfloor \frac{R}{L} \right\rfloor - 1 \text{ if } R \text{ is dividable to } L \tag{12}$$

$$Y = \left\lfloor \frac{R}{L} \right\rfloor \text{ if } R \text{ is not dividable to } L \tag{13}$$

N is the optimal number of each component.

2.9.2. The objective function

The objective function is the sum of all net present costs [15].

$$NPC = NPC_{w\text{g}} + NPC_{\text{el}} + NPC_{\text{tank}} + NPC_{\text{fc}} + NPC_{\text{refractor}} + NPC_{\text{conv}} \tag{14}$$

The objective function must be minimized. Such as minimization is done by PSO algorithm in this paper.

2.10. Particle swarm optimization

Particle swarm optimization was introduced in 1995 by Kennedy and Eberhart [16]. Although several modifications to the original algorithm have been made to improve its performance [17–21] and adapt it to specific types of problems [22–24], a parallel version has not been previously implemented. The following is a brief introduction to the operation of the PSO algorithm. Consider a swarm of p particles, with each particle's position representing a possible solution point in the design problem space D . For each particle i , Kennedy and Eberhart proposed that its position X^i be updated in the following manner:

$$X_{k+1}^i = X_k^i + V_{k+1}^i \tag{15}$$

With a pseudo-velocity V_{k+1}^i calculated as follows:

$$V_{k+1}^i = w_k V_k^i + c_1 r_1 (P_k^i - X_k^i) + c_2 r_2 (P_k^g - X_k^i) \tag{16}$$

Here, subscript k indicates a pseudo-time increment, P_k^i represents the best ever position of particle i at time k and P_k^g represents the global best position in the swarm at time k . r_1 and r_2 represent uniform random numbers between 0 and 1. To allow the product $c_1 r_1$ or $c_2 r_2$ to have a mean of 1, Kennedy and Eberhart proposed that the cognitive and social scaling parameters c_1 and c_2 be selected such that $c_1 = c_2 = 2$. The result of using these proposed values is that the particles overshoot the target half the time, thereby maintaining separation within the group and allowing for a greater area to be searched than if no overshoot occurred. Particles draw their strength from their cooperative nature, and are most effective when cognitive (c_1) and social (c_2) coexist in a good balance, i.e. $c_1 \approx c_2$. If $c_1 > c_2$, each particle is much attracted to its own personal best position, resulting in excessive wandering. On the other hand, if $c_2 > c_1$, particles are more strongly attracted to the global best position; causing particles are to rush prematurely toward optima. For unimodal problems with the smooth search space, a larger social component will be efficient, while rough multi-modal search spaces may find a larger cognitive component more advantageous.

We assumed $c_1 = c_2 = 2$, $w = 0.7$ and took a population size of $p = 60$ and the number of iterations of the algorithm was $g = 500$.

PSO algorithm is faster and less complicated than other methods such as genetic algorithm or ant colony algorithm in contrast to randomness of other methods.

3. Optimization procedure

The inputs of the optimization procedure are the capital costs, replacement costs, operation and maintenance costs of all components, as well as the efficiency, lifetime of components and

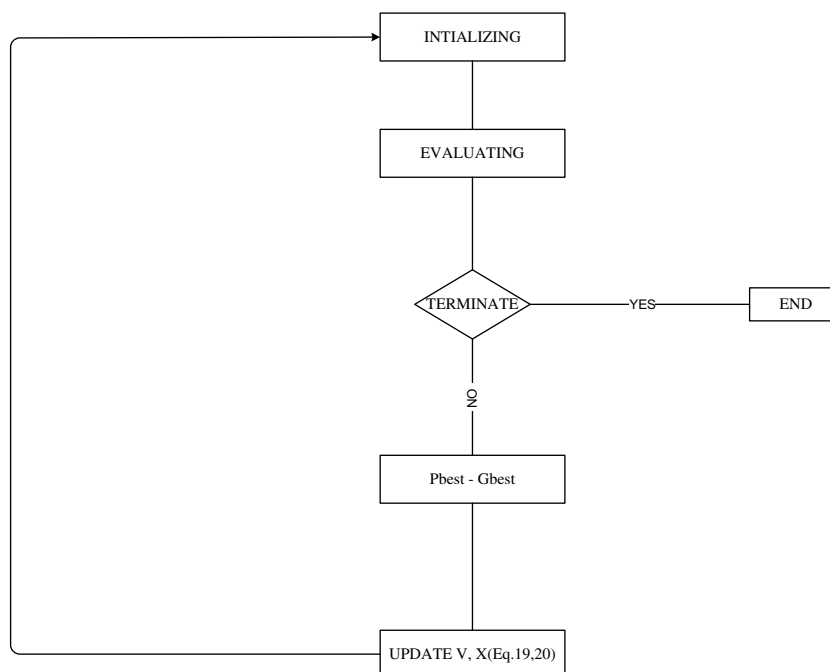

Fig. 6. The PSO optimization process.

lifetime of the project, specifications of all the components and the information on the area's population and produced waste. In this study, the sizes of wind turbines, fuel cells, electrolyzer and hydrogen tank have been optimized. However the values of variables mentioned below are fixed:

Cut-in wind speed (V_{cut-in}), cut-out wind speed ($V_{cut-off}$), nominal wind speed (V_{rated}), the efficiency, lifetime of components and lifetime of the project, interest rate, produced waste, hydrogen produced from waste and the sizes of reformer, anaerobic reactor and compressor.

For the sake of simplicity, we have considered the weekly mean in input data in our simulation. The data are the wind velocity and the demand in every one hour in a day. So, an average of the input data in each hour is calculated during a week. In a year, we have 1248 (52×24) data about the wind velocity and demand. PSO algorithm is initialized with two random vectors X_0, X_1 which are the initial positions of the particles. This procedure is performed for all of the particles (whose number is 60 in this study). Here X_0, X_1 are the sizes of the system, i.e. the variables of the objective function. They should satisfy the constraints of the problem, otherwise they will be chosen again until satisfaction of the constraints. Now, we calculate the objective function in X_0, X_1 and choose one of them which yields a smaller objective function as the best position of the particle and the best position of the group. The next position and velocity of the particle is determined according to Eq. (15), Eq. (16).

In each iteration, the best position of the particle and the best position of the group up to that iteration are calculated, as follows. In each iteration, the objective function is determined for each particle and is compared with the previous values. Thus the best position of each particle is evaluated, and the best position of the group is determined by comparing the best positions of the particles. By Eqs. (15) and (16) the next velocity and position are calculated, and finally, the best group position is the solution of the problem.

This method is not dependent only on the system costs. It also depends on the performance of the system. This means that if the obtained sizes do not satisfy the constraints, they are not selected as optimum sizes.

Some constraints must be satisfied as well. When the power produced by the wind turbines is less than the demand, the constraints are:

The fuel cell's power is then,

$$P_{fc_conv} = (P_{load}/\eta_{conv}) - P_{wg_conv}$$

If the obtained power is more than the optimum size ($P_{fc_conv} > (N_{fc} \times P_{fc})$).

In this case, the fuel cell cannot yield the needed power.

Hydrogen tank's energy in this case is

$$E_{tank(i)} = E_{tank(i-1)} + P_{comp_tank(i)} - P_{tank_fc(i)}$$

If the tank's energy obtained by above equation is less than zero, it means that the tank's hydrogen energy is not adequate to need the demand and the obtained sizes are not acceptable. When the constraints are not satisfied, the objective function becomes $1/eps$ in which $eps < < 1$.

Figs. 4–6 depict the system flowchart, simulation of system, and the flowchart of PSO algorithm respectively.

3.1. Simulation results

The nominal power 7.5 kw for each wind turbines, While it is 1 kw for each electrolyzer and each fuel cell. The size of each hydrogen tank is 1 kg, and the lifetime of the project is 20 years. In this study, the yearly load information and wind speed are considered to be these of Kahnouj site, located in the south-east part of Iran. The wind speed is depicted in Fig. 7. The power of the

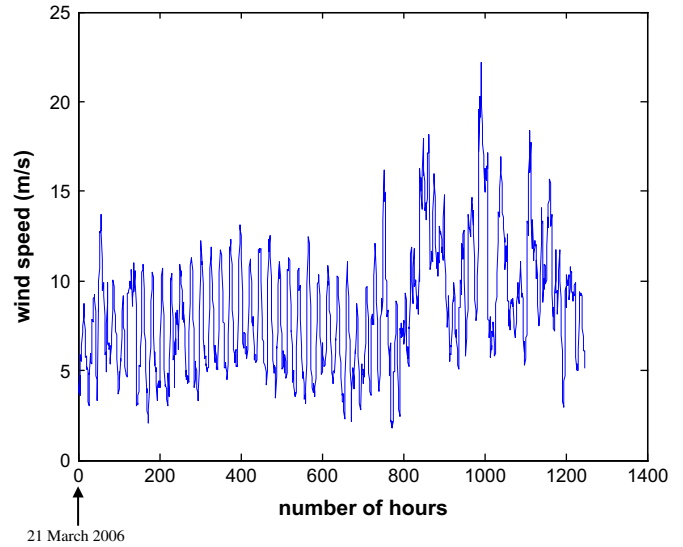

Fig. 7. Wind speed in a year.

wind turbine could be derived by Eq. (1) from the wind speed data. In fact, the output power of the wind turbine is not constant and depends on the wind speed. The optimal size of wind turbines, electrolyzer, hydrogen tank and fuel cell is 687, 2504, 2810, 1222 respectively and the optimal cost is 35.5\$M. Fig. 8 shows the system costs in terms of the iterations.

The sizes of reactor, reformer and compressor are fixed and equal to 750 kg/day, 31.2 kg H₂/day and 50 kw respectively. Results of different scenarios are shown in Fig. 9. As it could be seen (Fig. 9), increasing the interest rate causes the system costs to reduce which seems reasonable. Actually, considering Eq. (10), we realize that increasing the interest rate will result in a reduction in the present cost of the uniform annual payments. Furthermore, according to Eq. (11), an increase in the interest rate, cause single payment present worth to reduce. Consequently, we expect that an increase in the interest rate result in a decrement in those parts of the system costs which include annual or periodical payment (like maintenance costs and costs of replacement of the system component) and henceforth, the total net present cost of the system decreases. It is worth nothing that increasing the interest rate further justifies postponing the investments. This complies with reality, the more

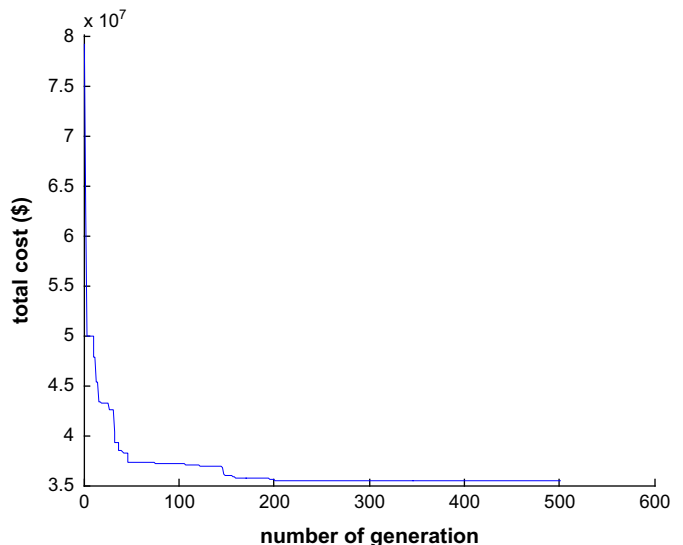

Fig. 8. The optimal cost of hybrid system in terms of the iterations.

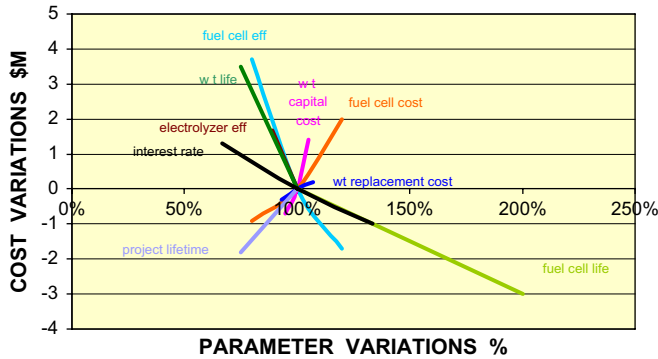

Fig. 9. Spider diagram for sensitivity analysis.

the interest rate increases, the more economically justifiable for the investor to reduce the invested money and postpone the payments to the future.

According to Fig. 9, increasing the efficiency of the fuel cell and electrolyzer causes the system costs to reduce. Moreover the sensitivity of the costs to the efficiency of the fuel cell and electrolyzer is approximately equal. (The slopes are almost equal).

Another point which could be seen in the Fig. 9 is that an increment in the costs of the wind turbine and the fuel cell, causes the system costs to increase, but sensibility of the system costs to increase in the costs of the wind turbine are more (The ratio of the amount of changes in the amount of in the costs of the system to the changes in the costs of wind turbine is more). Since the number of wind turbines is more and an increase in its costs has more observable effects on the system costs.

As it could be seen, if the lifetime of the wind turbine and the fuel cell is reduced, the costs of the system increase. However, due to a bigger number of wind turbine, the sensitivity of system costs to the lifetime of the wind turbine is more (The corresponding slope is more). Furthermore, decreasing the lifetime of the project reduces system costs considerably, since there is no need to the replacement of wind turbines.

Among the considered variable, the sensitivity of system costs to the capital costs of the wind turbines is higher, since their number is more and their costs contribute more to the system costs.

4. Conclusion

In this paper, the optimal sizing and operation strategy of hybrid system are considered. The system consists of wind turbines, fuel cells, an electrolyzer, hydrogen tanks, a reactor, a reformer and DC/AC converters. The hybrid system, which is used in this study, has high reliability because fuel cells are as a backup for wind turbines. Beside, hydrogen tank is fed by both electrolyzer and reformer, which cause increasing of reliability in providing load demand. The main problem of renewable energy source is that they are dependent on environmental conditions. So they could not cover the demand perfectly. Entering storage component solve this problem significantly. In this study hydrogen storage is used to cover the demand desirably. The hybrid system of wind-fuel cell is suitable for Kahnouj due to the following reasons:

1. Appropriate wind speed during the year
2. A huge amount of agricultural waste is available
3. High costs of fuel transition and pollution

Acknowledgment

The authors would like to sincerely thank the anonymous reviewer whose comments significantly enhanced some parts of this paper.

Reference

- [1] Patel MR. Wind and solar power systems. USA: CRC Press; 1999.
- [2] Samaras Z, Zafeiris D. Optimization of a wind-power fuel-cell hybrid system in an autonomous electrical network environment. *Renewable Energy* January 2007;32(1):57–79.
- [3] Nelson DB, et al. Unit sizing and cost analysis of stand-alone hybrid wind/PV/fuel cell power generation system. *Renewable Energy* August 2006;31(10):1641–56.
- [4] Kolokotsa D, et al. Methodology for optimal sizing of stand-alone photovoltaic/wind-generator systems using genetic algorithms. *Solar Energy* September 2006;80(9):1072–88.
- [5] Shahirinia AH, et al. Optimal sizing of hybrid power system using genetic algorithm. Netherlands: IEEE FPS; 2005.
- [6] Ghaemi S, Moghaddas-Tafreshi SM. Optimal sizing of grid connected hybrid power system in Geshm Island in Persian gulf of Iran. Vienna-Austria: IEWT; February 2007.
- [7] Khan MJ, Iqbal MT. Pre-feasibility study of stand-alone hybrid energy systems for applications in Newfoundland. *Renewable Energy* 2005;30(6):835–54.
- [8] <www.ballard.com>.
- [9] <www.avallence.com>.
- [10] A new biomass energy conversion technology yields methane for power generation, office of weatherization and intergovernmental program energy efficiency and renewable energy. U.S. Department of Energy; October 2002.
- [11] <www.mahler-ags.com>.
- [12] Ntziachristos L, et al. A wind-power fuel-cell hybrid system study on the non-interconnected Aegean island grid. *Renewable Energy* 2005;30:1471–87.
- [13] Moghaddas-Tafreshi SM, Hakimi SM. Optimal sizing of a stand-alone hybrid power system via particle swarm optimization (PSO). In: International power engineering conference-IPEC, Meritus Mandarin Singapor. p. 960–965, in press.
- [14] Hakimi SM, Moghaddas-Tafreshi SM. Unit sizing of a stand-alone hybrid power system using model-free optimization. Silicon Valley, USA: IEEE GRC, in press.
- [15] Hakimi SM, Moghaddas-Tafreshi SM. Unit sizing of a stand-alone hybrid power system using particle swarm optimization (PSO). *IEEE ICAL* Aug 2007;18–21:3107–12.
- [16] Kennedy J, Eberhart RC. Particle swarm optimization. In: Proceedings of the 1995 IEEE international conference on neural networks, Perth, Australia, vol. 4. Piscataway, NJ: IEEE Service Center; 1995. p. 1942–8.
- [17] Shi Y, Eberhart RC. A modified particle swarm optimizer. In: Proceeding of the IEEE international conference on evolutionary computation, Anchorage, Alaska. Piscataway, USA: IEEE Press; 1998. p. 69–73.
- [18] Shi Y, Eberhart RC. Parameter selection in particle swarm optimization. In: Porto VW, Saravanan N, Waagen D, Eiben AE, editors. Evolutionary programming VII. Lecture notes in computer science, vol. 1447. Berlin: Springer; 1998. p. 591–600.
- [19] Eberhart RC, Shi Y. Comparing inertia weights and constriction factors in particle swarm optimization. In: Proceedings of the 2000 Congress on Evolutionary Computation, IEEE Service Center, Piscataway, NJ; 2000. p. 84–8.
- [20] Clerc M. The swarm and the queen: towards a deterministic and adaptive particle swarm optimization. In: Angeline PJ, Michalewicz Z, Schoenauer M, Yao X, Zalzala A, editors. Proceedings of the congress of evolutionary computation, Washington DC, USA, vol. 3. New York: IEEE Press; 6–9 July 1999. p. 1951–7.
- [21] LZvbjerg M, Rasmussen TK, Krink T. Hybrid particle swarm optimiser with breeding and subpopulations. In: Proceedings of the third genetic and evolutionary computation conference (GECCO-2001), San Francisco, CA; 2001.
- [22] Fourie PC, Groenwold AA. Particle swarms in algorithm in topology optimization. In: Proceedings of fourth world congress of structural and multidisciplinary optimization, Dalian, China; May 2001. p. 52–3.
- [23] Carlisle A, Dozier G. Adapting particle swarm optimization to dynamic environments. In: International conference on artificial intelligence, vol. 1, Las Vegas, NV; 2000. 429–34.
- [24] Kennedy J, Eberhart RC. A discrete binary version of the particle swarm algorithm. In: Proceedings of the 1997 conference on systems, man and cybernetics. Piscataway, NJ: IEEE Service Center; 1997. p. 4104–9.
- [25] Committee on Alternatives and Strategies for Future Hydrogen Production and Use, National Research Council. The hydrogen economy: opportunities, cost, barriers and R&D needs. National Academies Press; 2004.