

BIG TUNNELS IN BAD ROCK
2000 TERZAGHI LECTURE

by Evert Hoek

ASCE Journal of Geotechnical and Geoenvironmental Engineering
Vol. 127, No. 9. September 2001, pages 726-740.

The Terzaghi lecture was presented at the ASCE
Civil Engineering Conference and Exposition
To be held in Seattle, October 18-21, 2000

Big Tunnels in Bad Rock

By Evert Hoek¹

ABSTRACT: Tunnels of 10 to 16 m span are frequently constructed for hydroelectric or transportation projects and many of these tunnels are excavated in rock masses of very poor quality. When the ratio of rock mass strength to in situ stress falls below 0.2, squeezing of the rock mass becomes a problem that can cause instability of both the tunnel and the face. A method for predicting squeezing conditions is presented and the practical options for pre-reinforcing the face and supporting the tunnel to deal with these problems are discussed. Two case histories are included to illustrate how these pre-reinforcement and support measures can be incorporated into a tunnel design. Brief discussions are also given on water problems in tunneling, the use of tunnel boring machines (TBMs) in squeezing ground and the construction costs for large tunnels in varying ground conditions.

INTRODUCTION

“Rock defects and loads on tunnel supports” by Karl Terzaghi (1946) was a landmark paper in tunneling literature and, for many years, it provided the basis for the rational design of tunnels, particularly those constructed in North America. There are still many valuable lessons to be learned from this work and it is recommended reading for anyone seriously interested in the practical aspects of tunnel design and construction.

The “tunnel supports” discussed by Terzaghi were primarily steel sets and these were designed to support the “rock load” due to the weight of the broken ground resulting from the excavation of the tunnel. This concept is illustrated in Fig. 1 and Terzaghi developed a set of guidelines for estimating the rock load for different geological conditions.

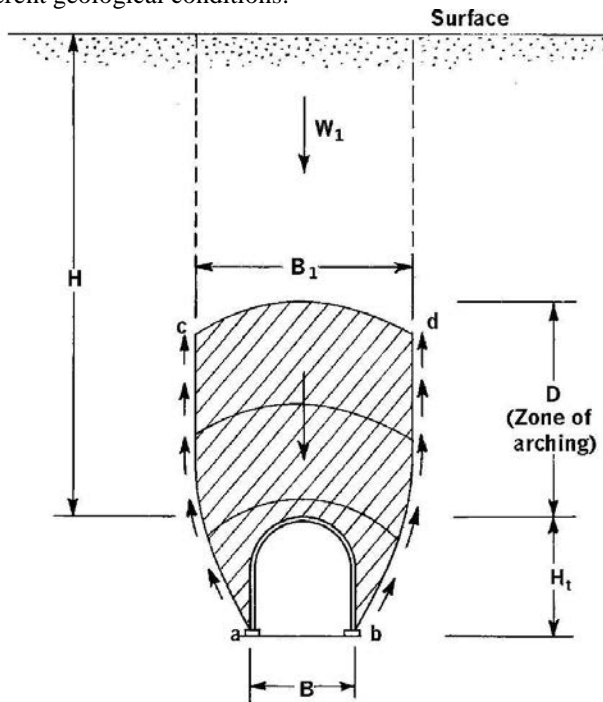

Fig. 1. – Terzaghi’s ground arch concept. Reproduced from “Rock defects and loads on tunnel supports” published in 1946.

¹Consulting engineer, 3414 Emerald Drive, North Vancouver, British Columbia, Canada V7R 3B5. Telephone + 1 604 988 3064, Fax + 1 604 980 3512, Email: ehok@attglobal.net.

An alternative tunnel support design method was developed in Europe and its origins can be traced to a paper by Fenner (1938). This method is based upon the development of a “plastic zone” in the rock mass surrounding a tunnel as illustrated in Fig. 2.

The support pressure p_i in Fig. 2 is that provided by the rock mass through which the tunnel is being advanced. At a distance of approximately one diameter ahead of the tunnel the rock mass is not influenced by the presence of the tunnel and the support pressure p_i equals the in situ stress p_o , corresponding to point A on the ground response curve. As the tunnel advances the support provided by the rock mass diminishes and the rock mass responds elastically up to point B at which plastic failure of the rock mass initiates. The radius r_p of the plastic zone and the radial convergence δ both increase as the support pressure decreases as illustrated in Fig. 2. Eventually, about two tunnel diameters behind the face, the support pressure p_i provided by the face has decreased to zero and the radial convergence δ reaches its final value.

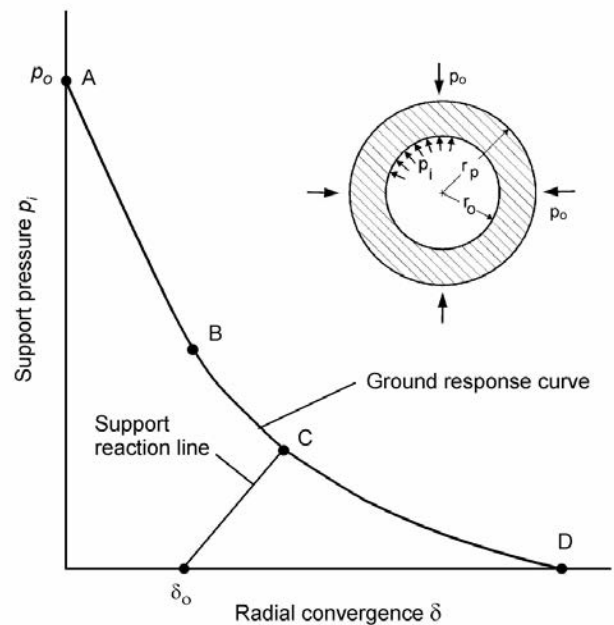

Fig. 2: A tunnel model and ground-support interaction curve for the rock mass surrounding a tunnel.

Tunnel support, which may be steel sets, rockbolts or shotcrete or some combination of these, is installed after the tunnel has converged a distance δ_0 . This support acts like a spring with the support that it provides to the tunnel increasing with convergence of the tunnel. The system reaches equilibrium at point C where the ground response curve and the support reaction line intersect.

Terzaghi (1925) published one of the first solutions for the elasto-plastic stress distributions around a cylindrical underground opening but he did not apply his calculations to the design of tunnel support systems. Between 1938, when Fenner's paper was published, and 1983, there were at least another 21 papers describing alternate solutions for the rock-support interaction analysis. Brown et al (1983) reviewed these solutions and they also published their own analysis. There have been several additional rock-support interaction solutions published since 1983.

The behavior of the tunnel face was not considered in either the Terzaghi "rock load" design method or the rock-support interaction analysis. This omission was not important for relatively shallow, small tunnels since it was usually possible to devise some practical means for supporting the face if this proved to be necessary. However, as both the size of tunnels and their depth below surface increased, the stability of the face became a serious issue. This is illustrated in Fig. 3 that shows the plastic extrusion of a tunnel face as determined by means of an axi-symmetric finite element model. Lunardi (2000) has suggested that understanding and controlling the behavior of the "core" ahead of the advancing tunnel face is the secret to successful tunneling in squeezing ground conditions.

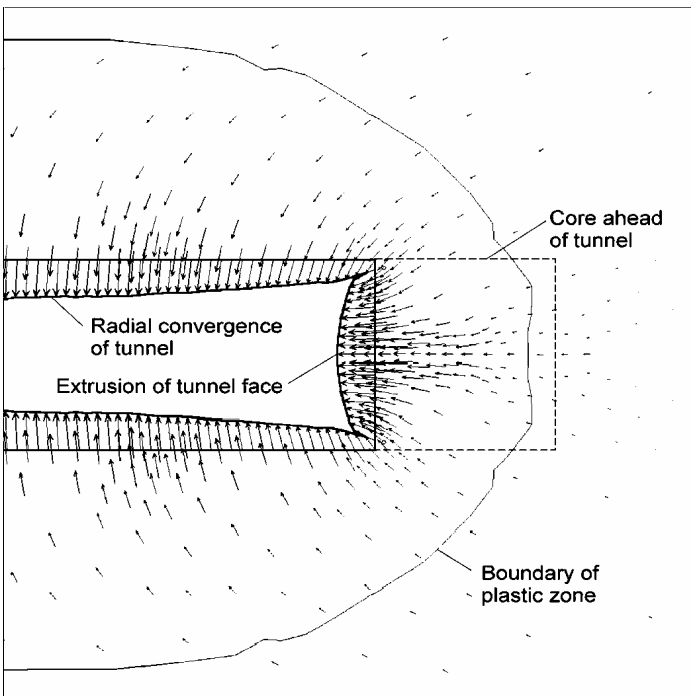

Fig. 3: Section through an axi-symmetric finite element model showing the extrusion of the tunnel face as a result of failure of the core ahead of the tunnel.

TUNNEL FACE STABILITY

The ground reaction curves plotted in Fig. 4 were calculated for an 8 m diameter tunnel using the parameters defined in the figure. Displacements were measured at a point 20 m behind the tunnel face (A) and in the center of the face (B) and these values define the ground response curves illustrated. It is clear that, for this example, the tunnel face follows the same general deformation pattern as the tunnel itself although the displacements are about 30% smaller. Note that, for support pressures greater than 6 MPa, the rock behaves elastically and the displacement curves follow straight lines up to the point (0,12).

The practical consequence of this observation is that, when it becomes necessary, the tunnel face has to be stabilized in order to provide safe working conditions and to ensure that the tunnel can be advanced. It would clearly be of great benefit to the tunnel designer to know the conditions that can give rise to instability of the face and the tunnel and how much effort has to be expended to stabilize both.

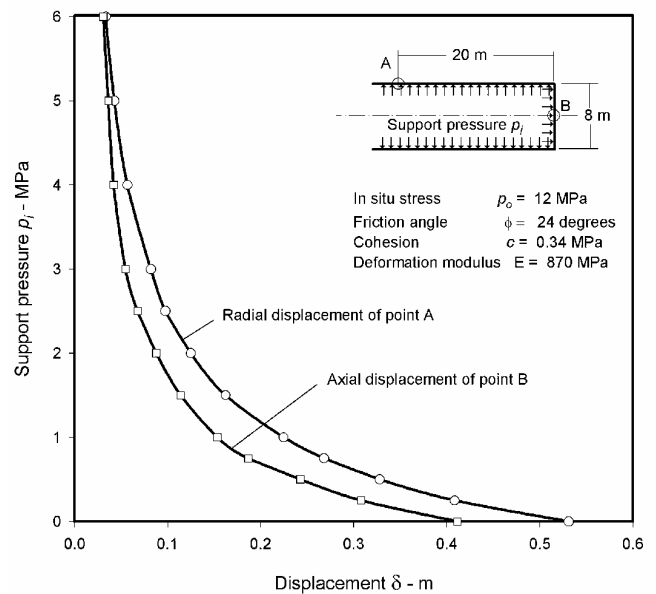

Fig. 4: Ground response curves for an 8 m diameter tunnel in squeezing rock, calculated by means of an axi-symmetric finite element model.

PREDICTION OF TUNNEL AND FACE INSTABILITY

In order to analyze the behavior of the tunnel and its face under a variety of conditions, some means of estimating the properties of the rock mass is required. The system proposed by Hoek and Brown (1980, 1997) is one of the most widely accepted means for assessing rock mass properties and this system will be used here. Hoek and Marinos (2000) have described recent modifications to this system and its application to rock mass of poor quality.

Hoek and Marinos (2000) showed that a plot of tunnel strain against the ratio of rock mass strength to in situ stress provides a basis for estimating the potential for tunnel instability. In this context, strain is defined as the percentage ratio of tunnel wall deformation to tunnel radius. The plot referred to was produced

by carrying out Monte Carlo analyses, using the two-dimensional closed form analytical solutions by Duncan-Fama (1993) and by Carranza-Torres and Fairhurst (1999), for a very wide range of rock mass properties and in situ stress conditions. This analysis was for the tunnel only since neither of these solutions consider the stability of the face.

Similar curves relating strain to the ratio of rock mass strength to in situ stress can be generated for the three-dimensional case by means of the axi-symmetric finite element model² that was used to produce the results presented in Figs. 3 and 4. These curves are plotted in Fig. 5 and they show that the strain increases asymptotically when the ratio of rock mass strength to in situ stress falls below about 0.2. This indicates the onset of severe instability and, without adequate support, the tunnel and the face would both collapse.

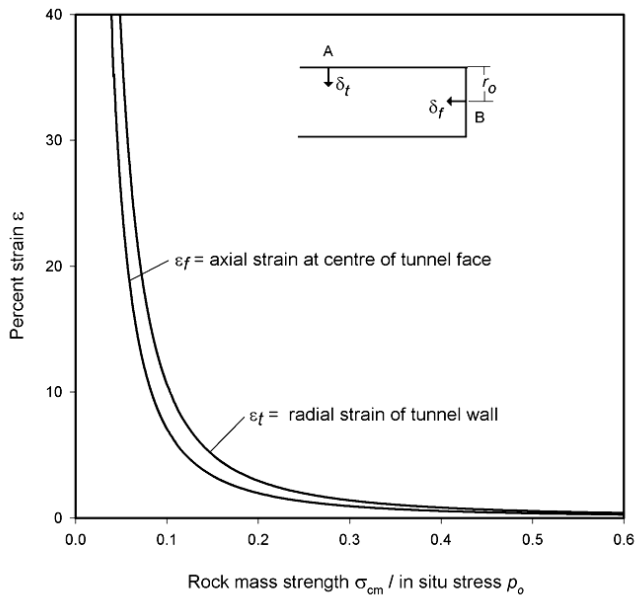

Fig. 5: Relationship between rock mass strength σ_{cm} to in situ stress p_o and the percentage strain ϵ for unsupported tunnels. The strain ϵ_t is defined as the percentage ratio of radial tunnel wall displacement to tunnel radius while the strain ϵ_f is the percentage ratio of axial face displacement to tunnel radius. Note that this analysis is for a circular tunnel subjected to equal horizontal and vertical in situ stresses.

The influence of internal support pressure p_i upon the strain of the tunnel and the face was also investigated by means of the axi-symmetric finite element model. This was done for a range of different rock masses, in situ stresses and support pressures. Curve fitting to the results of these analyses gave the following approximate relationships for the strain of the tunnel ϵ_t and the face ϵ_f and the ratio of support pressure to in situ stress:

$$\epsilon_t \% = 0.15(1 - (p_i/p_o)) \frac{\sigma_{cm}}{p_o}^{-\frac{(3p_i/p_o)+1}{(3.8p_i/p_o)+0.54}} \dots(1)$$

² All of the finite element studies reported in this paper were carried out using the model Phase2. Details of this model are available from www.rocsience.com.

$$\epsilon_f \% = 0.1(1 - (p_i/p_o)) \frac{\sigma_{cm}}{p_o}^{-\frac{(3p_i/p_o)+1}{(3.8p_i/p_o)+0.54}} \dots(2)$$

Note that these relationships probably represent lower bound conditions since they were all derived from axi-symmetric finite element analysis assuming zero dilation of the rock mass. This assumption is considered appropriate for the very poor quality rock masses considered here. On the other hand, the curves published by Hoek and Marinos (2000) were derived for a wider range of mass properties including, in some cases, significant dilation. In addition, for a given set of rock mass properties and in situ stresses, the two-dimensional closed-form solutions predicted larger displacements than the corresponding axi-symmetric finite element analyses.

CASE HISTORIES OF SQUEEZING TUNNELS

Based on field observations and measurements, Sakurai (1983) suggested that tunnel strain levels in excess of approximately 1% are associated with the onset of tunnel instability and with difficulties in providing adequate support. Field observations by Chern et al (1998), plotted in Fig. 6, confirm Sakurai's proposal.

Note that some tunnels which suffered strains as high as 5% did not exhibit stability problems. All the tunnels marked as having stability problems were successfully completed but the construction problems increased significantly with increasing strain levels. Hence, the 1% limit proposed by Sakurai is only an indication of increasing difficulty and it should not be assumed that sufficient support should be installed to limit the tunnel strain to 1%. In fact, in some cases, it is desirable to allow the tunnel to undergo strains of as much as 5% before activating the support.

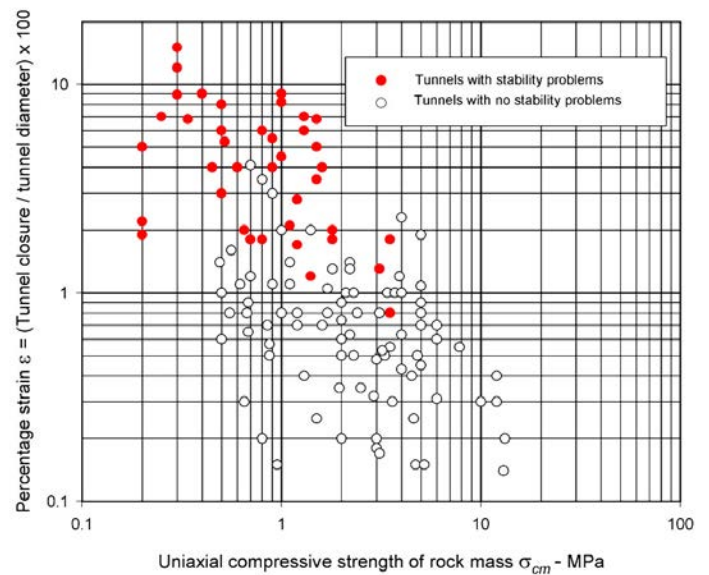

Fig. 6 Field observations by Chern et al (1998) from the Second Freeway, Pinglin and New Tienlun headrace tunnels in Taiwan.

Apart from observations published by Lunardi (2000) there are very few reliable measurements of tunnel face extrusion. Hence, all of the field observations included in this discussion are for radial strain of the tunnel.

One of the problems in interpreting field observations of tunnel squeezing is that of estimating the influence of the tunnel support. It is particularly difficult when the support capacity is exceeded and where steel sets buckle, shotcrete cracks or rockbolts yield. The best that can be done under these circumstances is to plot the observations and to compare them with strain curves for a range of support pressures. This has been done in Fig. 7 that shows observed closures for a number of tunnels in Venezuela, Taiwan and India. Details of the observations are tabulated in Appendix I.

Fig. 7 shows that the observations are in reasonable agreement with the squeezing behavior predicted by Eq. 1. The points marked 1, 2, 5 and 7 are for tunnels in which severe squeezing occurred and where extraordinary steps had to be taken to stabilize the tunnels.

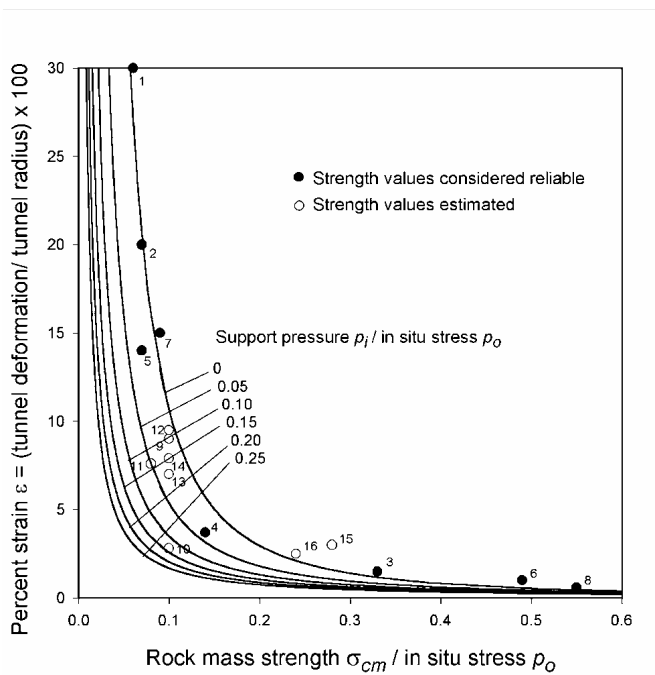

Fig. 7: Influence of internal support pressure p_i upon the deformation of tunnels in weak ground. The numbered points are from case histories listed in Appendix II.

The Yacambú-Quibor tunnel (Fig. 7, point 1) is a 5.5 m span 25 km long water transmission tunnel being excavated through the Andes near the city of Barquisemeto in Venezuela. The maximum cover on this tunnel is 1270 m and a significant proportion of the rock through which it is mined is graphitic phyllite. Construction of this tunnel, regarded by many as the most difficult tunnel in the world, commenced in 1975 and approximately 9 km remains to be excavated in 2000. In 1979 a tunnel boring machine was trapped by squeezing rock during a stoppage in the drive. The machine could not be restarted and the squeezing rock gradually filled all the cavities in the machine structure. The remains of this machine were removed several years later and Fig. 8 shows this excavation in progress. Complete closure of this tunnel occurred in several locations

and a technique was eventually developed to control the stability of the tunnel by installing steel sets with sliding joints that locked after the tunnel had converged about 0.3 m (equivalent to a strain of approximately 6% after the installation of the sets). These sets were fully embedded in shotcrete except for 1 m wide gaps over the sliding joints. After the tunnel face had advanced 5 to 10 m the joints had closed and the sets began to accept load. The gaps were filled with shotcrete to complete the lining. Convergence measurements have shown that these sections are stable and the long-term behavior of this support has been excellent (Sánchez Fernández and Terán Benítez, 1994).



Fig. 8: Yacambú-Quibor tunnel in Venezuela. Mining out the remains of a tunnel boring machine trapped by squeezing of the tunnel during a stoppage of the drive.

Point number 2 in Fig. 7 is for a 10 m diameter hydropower headrace tunnel on the Nathpa Jhakri project in India (Hoek, 1999). In a section of the tunnel passing through a wide fault zone under a cover of 300 m, severe deformations occurred as illustrated in Fig. 9. The deformed section was re-mined under the protection of a forepole umbrella. The remainder of the fault zone was successfully traversed using this method. The installation of the forepoles is illustrated in Fig. 10.

Point number 7 in Fig. 7 is for the 16 m span Mucha highway tunnel in Taiwan (Chern et al, 1998). Inward displacements of the roof and sidewalls of approximately 1.2 m (equivalent to a strain of about 15%) occurred when a fault zone was encountered. The reduction in cross-section of the tunnel meant that re-mining to the original tunnel profile was necessary. This involved heavy support using long tensioned grouted cables that were used to support the failed rock mass while it was mined section-by-section. The re-mined section was stabilized by additional tensioned grouted cables and the final concrete lining was placed as soon as possible after completion of the remedial work.



Fig. 9: Severe squeezing in a fault zone encountered by the 10 m span top heading of the headrace tunnel for the Nathpa Jhakri hydroelectric project in India.



Fig. 10: Drilling unit for the installation of 12 m long 75 mm diameter pipe forepoles to form a protective umbrella under which the headrace tunnel was successfully mined through the fault zone in the Nathpa Jhakri headrace tunnel.



Fig. 11: Re-mining the perimeter of the 16 m span Mucha tunnel in Taiwan after severe squeezing in a fault zone. Photograph reproduced with permission from Sinotech Engineering Consultants Inc., Taipei.

SUPPORT OPTIONS FOR SQUEEZING GROUND

On the basis of the preceding discussion, the curve defined by Eq. 1 can be used to give a set of approximate guidelines on the degree of difficulty that can be encountered for different levels of strain. Since these strain levels are associated with specific ranges of the ratio of rock mass strength to in situ stress, the curve given in Fig. 12 can be used to give a first estimate of tunnel squeezing problems.

For example, during site investigations for a tunnel, one of the rock masses through which the tunnel will be excavated is identified as having strength $\sigma_{cm} = 1.5$ MPa (based upon the methodology described by Hoek and Marinos, 2000). The tunnel will pass through this rock mass at an average depth of 500 m which means that the in situ stress level will be $p_o = 13.5$ MPa and the ratio $\sigma_{cm} / p_o = 0.11$. Fig. 12 shows that this corresponds to a strain of approximately 10% and the tunnel designer should therefore anticipate having to deal with very severe squeezing problems in this section.

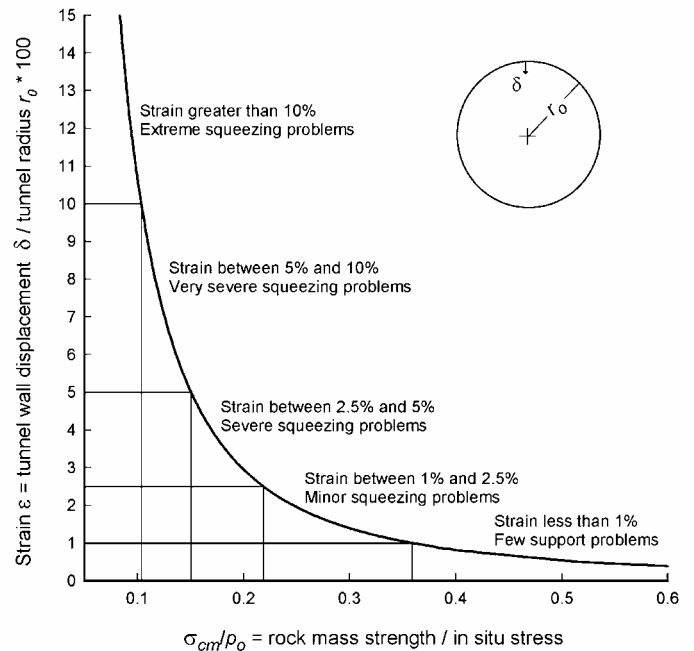

Fig. 12: Tunneling problems associated with different levels of strain.

For strain levels of less than 1% experience suggests that there are few problems with tunnel stability. These strain levels generally occur in hard, strong rocks at relatively shallow depth and the main stability problems are those due to gravity falls of structurally defined blocks or wedges. Support for these conditions is usually designed on the basis of safety for the workmen in the tunnel and rockbolts and shotcrete or light steel sets are commonly used for this purpose. As this type of support has been extensively covered in tunneling literature it will not be discussed further here.

Another type of tunnel stability problem that will not be dealt with in this discussion is that of slabbing, spalling and rockbursts which occur in hard, massive rocks at very high stress levels. These problems have also been discussed extensively, particularly in mining literature.

The primary interest here is to review the options that are available for dealing with squeezing ground conditions and to suggest which of these options may be most appropriate for different levels of strain. In particular, the problem of large tunnels needs to be addressed since such tunnels, with spans ranging from 10 to 16 m, are becoming increasingly common in hydroelectric and transportation projects around the world.

From the preceding discussion it can be appreciated that the stability of the face of a tunnel is a critical factor in driving large tunnels through squeezing ground. Instability of the face not only creates extremely dangerous conditions for the workmen in the tunnel but it also has a major impact on the subsequent behavior of the tunnel. Unless this instability is dealt with in an appropriate manner significant damage may occur in the rock mass surrounding the tunnel due to the formation of cavities from collapse of material at the face or through gaps in the support system. This damage may require time-consuming and expensive treatment once the face has advanced through the fault or, if left untreated, it may cause problems later during the operating life of the tunnel.

If the fault is anticipated, for example by probe drilling ahead of the face, and a well designed plan of attack is developed by the tunnel designer and the contractor, the squeezing problems can usually be overcome. The rock mass surrounding the tunnel may be improved by grout injection, placement of grouted pipe forepoles or reinforcement with grouted fiberglass dowels. While this treatment will be slow and expensive, it is more likely to succeed and to minimize subsequent problems than the more typical approach where no pre-reinforcement is used and where problems are dealt with as they are exposed in the face.

Methods for dealing with face stability in squeezing ground have been developed mainly in Europe to deal with tunneling through the Alps (Schubert, 1996). These methods can be divided into three distinct categories. One of these involves driving small size headings in advance of other portions of the face. This method, which tends to be favored by tunnel designers north of the Alps, relies on the fact that the sequential construction process results in the creation of a very strong shotcrete shell. The alternative approaches, typically used by tunnel designers from south of the Alps, are to drive a tunnel full-face or by top heading and bench excavation, and to rely on reinforcement of the face and the rock mass surrounding the tunnel to stabilize the tunnel. Fig. 13 presents a brief summary of representative options for the control of tunnel face stability and the subsequent installation of support for the tunnel while Fig. 14 shows a typical field installation in which many of the support elements have been incorporated.

All of the approaches illustrated in Fig. 13 have advantages and disadvantages and there are no simple rules for deciding which method is better for a particular set of circumstances. For relatively mild squeezing conditions rockbolts and shotcrete are used as the primary elements in all of these support systems. In the case of the multiple heading method, the face is divided into a larger number of headings as squeezing becomes more severe. This ensures that the outer reinforced shotcrete shell is not overstressed at any stage in the excavation process. The stability of the smaller faces is also easier to control.

For the top heading and bench and full face excavation options, heavier and more closely spaced steel sets are added as the severity of squeezing increases. For very severe squeezing conditions, grouted fiberglass dowels are added for face

reinforcement and forepoles or similar reinforcing elements are used to pre-reinforce the rock mass ahead of the advancing face.

While this pre-reinforcement is very effective in protecting the rock core ahead of the face, it can become a liability once it is exposed in the tunnel. As illustrated in Fig. 14, the exposed ends of the forepoles have to be supported by steel sets installed as close to the face as possible. It is particularly important that foundation failure of the bases of the steel sets is prevented by the provision of some form of footing or anchoring system. A frequent design error is the use of excessively large forepoles that, while they provide good support for the rock mass ahead of the face, tend to overload the steel sets behind the face.

Eventually a point is reached where it is difficult to provide support of sufficient capacity, particularly if extremely severe squeezing is associated with very poor quality rock masses in which rockbolts are ineffective. In such cases it may be necessary to allow the support to yield in a controlled manner so that its capacity is only mobilized after significant displacement. As illustrated in Figs. 2 and 4, this results in a reduction in the support pressure required to stabilize the tunnel and the face.

In the case of the 5.5 m span Yacambú-Quibor tunnel described earlier, very large deformations were accommodated by using sliding joints in the steel sets (Sánchez Fernández and Terán Benítez, 1994). An alternative system is to use support elements that are designed to deform plastically in a controlled manner as described by Schubert (1996).

When a large tunnel is required to deal with high volume hydraulic flow or a two-lane transportation system, the tunnel can be split into two smaller tunnels, which are generally easier to support. This method has been used successfully for crossing wide fault zones.

In very poor ground it is difficult to keep drillholes open and it may be necessary to use self-drilling rather than conventional rockbolts. These are rockbolts fitted with disposable drill bits that are left in place at the bottom of the holes. In extremely poor quality ground, particularly where clay minerals are present, self-drilling rockbolts may be ineffective because of failure of the bond between the grout and the surrounding rock.

The multiple heading method tends to be safer than the full-face method but it places high demands on careful design of details in the support system and on the quality of workmanship required to implement the design. The full-face method carries a relatively high risk since failure of any part of the support system can result in collapse of a large volume of material. On the other hand, when implemented correctly, the method can be very effective.

The final choice of the method to be used for a specific situation depends upon the complex interaction of a number of factors. In addition to safety, cost and schedule considerations, these factors also include the relevant experience of the contractor, the designer and of consultants engaged to assist in the project. The successful implementation of the methods illustrated in Fig. 13 depends more upon experience-based judgment than on theoretical calculations. In particular, the experience of and the authority given to the individual directing the work at the face is crucial, since there is seldom time for lengthy academic discussions when dealing with unstable tunnel face problems. Wherever possible this individual should be an engineer since it is not only experience but also an understanding of the mechanics of rock-support interaction that will dictate the choice of the most appropriate course of action.

Fig. 13: Face excavation and support options for large tunnels.

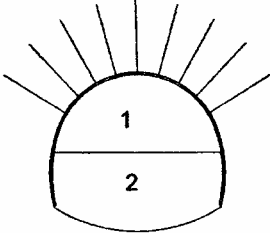
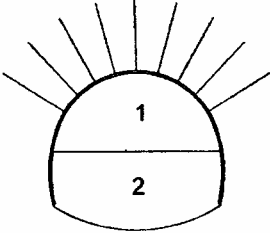
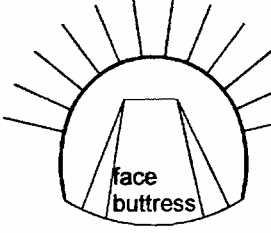
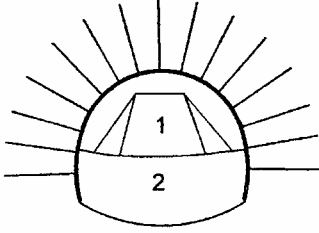
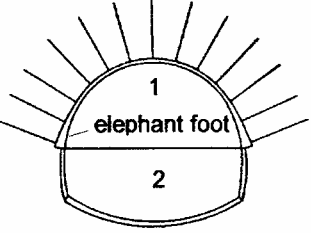
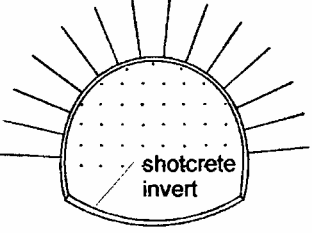
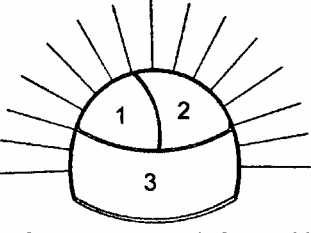
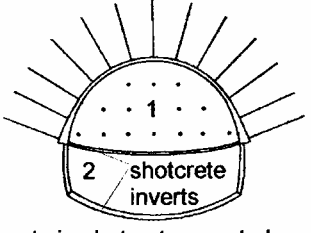
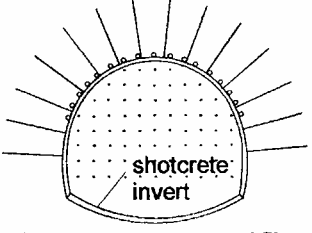
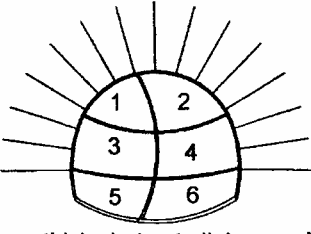
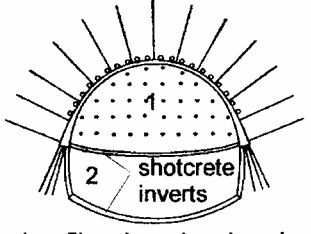
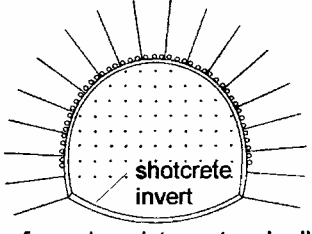
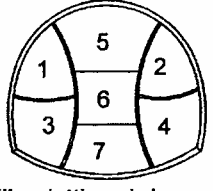
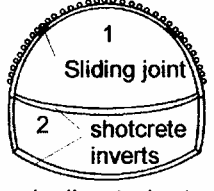
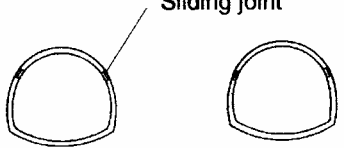
	MULTIPLE HEADINGS	TOP HEADING AND BENCH	FULL FACE EXCAVATION
NO SQUEEZING	 <p>Safety rockbolts in crown with 50 mm thick shotcrete</p>	 <p>Safety rockbolts in crown with 50 mm thick shotcrete</p>	 <p>Safety rockbolts, 50 mm thick shotcrete and face buttress</p>
MINOR SQUEEZING	 <p>Rockbolts, 100 mm thick shotcrete and face buttress</p>	 <p>Steel sets in shotcrete with elephant foot and invert lining</p>	 <p>Lattice girders, shotcrete, fiber-glass dowels grouted in face</p>
SEVERE SQUEEZING	 <p>Partial face excavation, 150 mm thick shotcrete lining and invert</p>	 <p>Steel sets in shotcrete, grouted fiberglass dowels in face</p>	 <p>Forepoles, steel sets, grouted fiberglass dowels in face</p>
V. SEVERE SQUEEZING	 <p>200 mm thick shotcrete linings, self-drilling rockbolts</p>	 <p>Forepoles, fiberglass dowels, micropile foundations for sets</p>	 <p>Dense forepole or jet grout umbrella and face support</p>
EXTREME SQUEEZING	 <p>Central pillar, lattice girders embedded in 250 mm thick shotcrete lining, no rockbolts</p>	 <p>Forepole umbrella, steel sets with sliding joints, close temporary and final inverts</p>	 <p>Split into two smaller tunnels and use steel sets with sliding joints in 250 mm shotcrete</p>

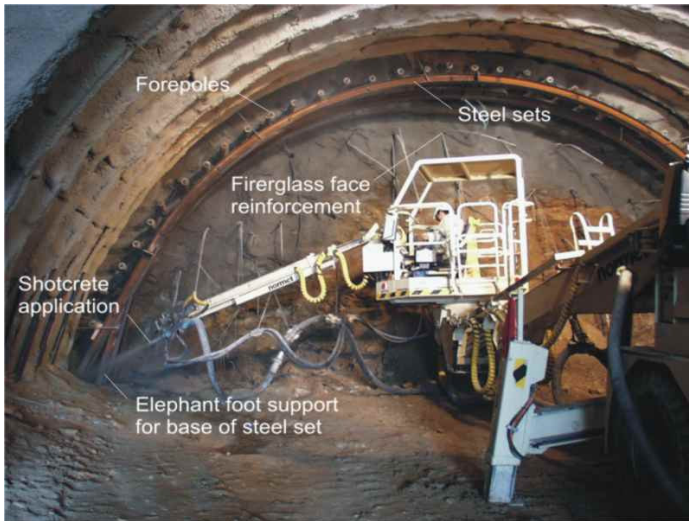

Fig. 14: A top heading excavation with steel sets supporting the undermined portion of a forepole umbrella. Enlarged footings (“elephant’s feet”) have been used to prevent foundation failure at the base of the sets. The sets and the forepoles are fully embedded in shotcrete to form a very strong structural shell. The face is supported by means of grouted fiberglass dowels.

EXAMPLES OF SUPPORT DESIGN

Fig. 15 shows one possible method for driving a tunnel through squeezing ground. In order to illustrate the design procedure that would be used in such a case, a set of calculations is described and comments are given on the assumptions made and the reliability of each calculation step.

The tunnel has an excavated span of 12.15 m and an 11 m span, measured inside the final concrete lining. The cover over the tunnel crown is 44 m and the poor quality flysch in which it is to be excavated has a friction angle $\phi = 23^\circ$, a cohesive strength of 0.06 MPa and a deformation modulus of 308 MPa. The estimated rock mass strength is $\sigma_{cm} = 0.17$ MPa and, for an in situ stress of $p_o = 1.35$ MPa, this gives a ratio of rock mass strength to in situ stress $\sigma_{cm}/p_o = 0.13$. Eq. 1 gives an estimated strain of 7% under these conditions and this suggests that very severe squeezing and face instability problems are likely unless appropriate support measures are implemented.

In this example the friction angle of 23° and this suggests that the rock mass has a low clay mineral content and that its behavior is sufficiently frictional to justify the use of 6 m long 32 mm diameter fully grouted untensioned rockbolts for the tunnel arch and sidewalls and of 12 m long grouted fiberglass dowels for face support. Because of the anticipated face stability problems, a forepole umbrella consisting of 114 mm diameter pipes at 500 mm center to center spacing will be used over an arc of about 140° . These forepoles are 12 m long and successive umbrellas are installed at 8 m spacing, giving an overlap of 4 m between umbrellas.

The pipe forepoles are installed one by one, after each hole has been drilled, and they are fully grouted as soon as possible after installation. Under no circumstances should the contractor be permitted to drill all the holes before installing the forepoles. This can weaken the rock mass and achieve exactly the opposite effect to that desired.

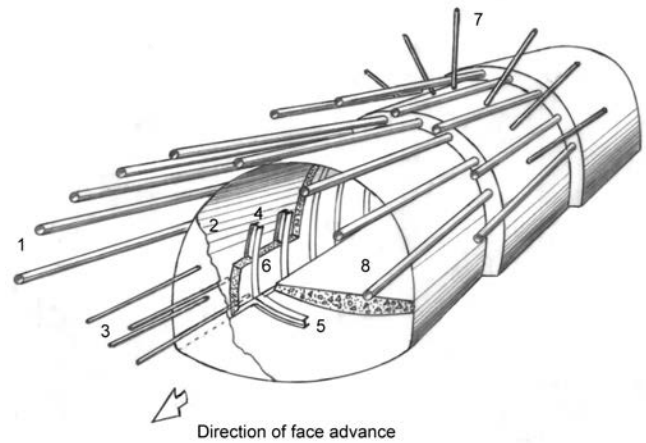

- 1 Forepoles – typically 75 or 114 mm diameter pipes, 12 m long installed every 8 m to create a 4 m overlap between successive forepole umbrellas.
- 2 Shotcrete – applied immediately behind the face and to the face, in cases where face stability is a problem. Typically, this initial coat is 25 to 50 mm thick and it is to prevent deterioration of the exposed rock surfaces.
- 3 Grouted fiberglass dowels – Installed midway between forepole umbrella installation steps to reinforce the rock immediately ahead of the face. These dowels are usually 6 to 12 m long and are spaced on a 1 m x 1 m grid.
- 4 Steel sets – installed as close to the face as possible and designed to support the forepole umbrella and the stresses acting on the tunnel.
- 5 Invert struts – installed to control floor heave and to provide a footing for the steel sets.
- 6 Shotcrete – typically steel fiber reinforced shotcrete applied as soon as possible to embed the steel sets to improve their lateral stability and also to create a structural lining. This shotcrete may be up to 150 mm thick.
- 7 Rockbolts as required. In very poor quality ground it may be necessary to use self-drilling rockbolts in which a disposable bit is used and is grouted into place with the bolt.
- 8 Invert lining – either shotcrete or concrete can be used, depending upon the end use of the tunnel.

Fig.15: Full face tunnel excavation through weak rock under the protection of a forepole umbrella. The final concrete lining is not included in this figure.

A 0.6 m thick final concrete lining, reinforced where necessary, will be placed after completion of the excavation. This lining will be surrounded by an impermeable plastic membrane that will be drained by means of geotextile drainage layers leading the water to drainage pipes on either side of the base of the tunnel excavation.

Fig. 16 illustrates a finite element model that was constructed to investigate the proposed excavation sequence for this case. This model involved 8 stages of excavation and support installation or activation as defined in the table included in the figure.

At this time there are no generally accepted methods for designing forepole umbrellas. These forepoles form a shell that reduces the gravitational stress acting on the rock core ahead of the advancing tunnel face. The correct way to approach this problem is by means of a full three-dimensional numerical

analysis in which the forepoles are installed as structural elements embedded in the rock mass. Suitable programs for such analyses are available but they have not been used yet for systematic studies of the stress distribution and progressive failure of the rock mass under the umbrella. A few studies have been carried out using simpler axi-symmetric models.

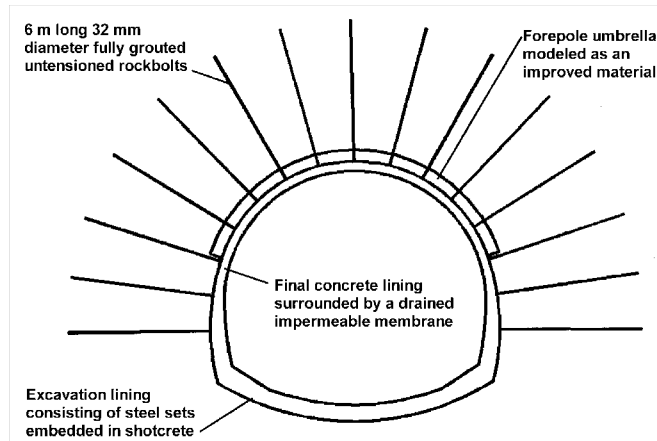

Stage	Support element / force	Comments
1	Forepole umbrella	The forepole umbrella is modeled by improving the properties of a 0.6 m thick zone using a weighted average (based on cross-sectional area) of the properties of the pipes, the grout and the rock mass.
2	Internal support pressure	An internal support pressure of 0.7 MPa is applied to limit the displacement of the tunnel walls to 50% of the total final value. This is estimated to be the displacement before the installation of support.
3	Rockbolts and steel sets embedded in shotcrete	Installation of support consisting of rockbolts and steel sets embedded in shotcrete, modeled by means of beam elements with properties determined from the components.
4	Removal of internal support pressure	Activation of the installed support by removal of the internal pressure to allow the tunnel to deform.
5	Reduction of support capacity of forepoles	As the face advances the capacity of the forepole umbrella is reduced due to the fact that support is no longer available to allow it to act as a fully effective shell and the capacity is reduced to that of the rock mass.
6	Installation of final concrete lining	The final concrete lining is cast in place in the deformed but stable tunnel.
7	Elimination of rockbolts	Over a period of tens of years it is assumed that the rockbolts corrode and that their capacity is eventually reduced to zero.
8	External water pressure on concrete lining	In the event of long-term blocking of the drains the water pressure can build up to its original level. In this case it is assumed that the water pressure could reach a maximum associated with the water table being coincident with the ground surface.

Fig. 16: Finite element model for investigation construction sequence and effectiveness of support.

The fact the no reliable means for designing forepoles exists represents a challenge for the geotechnical research community. Three-dimensional numerical analyses, supported by physical model studies and field measurements of the performance of installed umbrellas, would provide a basis for understanding the complex interaction between these support elements and the deforming rock mass.

In the mean time, in order to provide a logical basis for the design of a forepole umbrella, some form of two-dimensional approximation is generally used. A very crude approach is to assume that a zone of "improved" rock can be used to simulate the forepole arch and this is the approach that has been followed in the example given in Fig. 16. The improvement of rock mass properties is estimated by considering the weighted average (based on cross-sectional areas) of the strength and deformation properties of the steel forepoles, the grout filling and the original rock mass. While this model does not correctly represent the three-dimensional bending strength of the umbrella, it does permit the construction of a two-dimensional model that behaves well numerically. More importantly, the actual performance of tunnels constructed with forepole umbrellas designed in this manner confirms that the improved strength estimates appear to be reasonable.

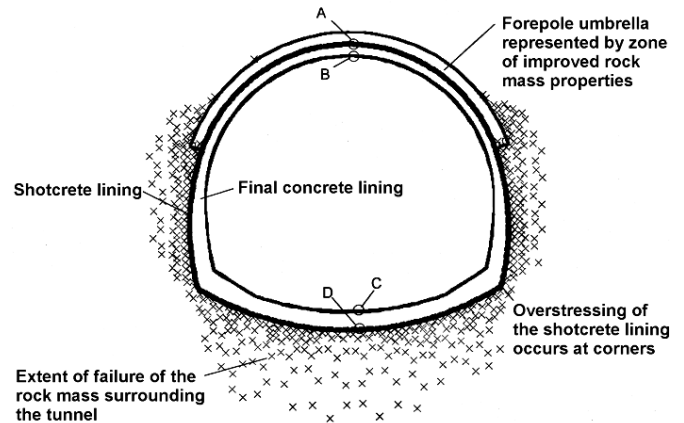

Stage	Displacement - mm				Remarks
	A	B	C	D	
1	0	-	-	0	Installation of forepole umbrella
2	12	-	-	24	Excavation with internal pressure of 0.7 MPa
3	12	-	-	24	Installation of rockbolts and shotcrete lining
4	17	-	-	39	Removal of internal pressure to activate support
5	18	-	-	38	Reduction of support capacity of forepole umbrella
6	19	4	3	37	Installation of concrete lining with deformation due to the self-weight to the concrete
7	19	4	3	37	Elimination of rockbolts (displacements too small to measure)
8	21	1.7	8	42	External water pressure on lining

Fig. 17: Results of the final stage of the finite element model analysis. Note that the rockbolts have been removed in this stage to represent complete corrosion of the steel. In addition, the outer perimeter of the concrete lining is subjected to a uniform external pressure of 0.5 MPa to represent the maximum water pressure that can occur if all drains are blocked.

The results obtained from this model are illustrated in Fig. 17 that shows the extent of rock mass failure around the tunnel. The displacements of the crown and invert, for both the tunnel and the concrete lining, are given in the table included in Fig. 17. It can be seen that the excavation support system comes under full load in stage 4 and that displacements of 17 mm and 39 mm occur at points A and D in the roof and floor respectively. Without support the same model indicated a displacement of more than 4 m at point A in the roof and shows that the failure extends to the ground surface, resulting in a surface settlement of almost 2 m above the tunnel. Hence, the installed support is clearly necessary and, as demonstrated by this analysis, it is effective.

This analysis indicates overstressing of the shotcrete in the two “corners” at the ends of the invert in step 4 of the loading process. The extent of this overstressing does not increase during subsequent loading stages. This behavior is common where a sudden change of curvature occurs and it does not usually give rise to any significant practical problems. In any case the shotcrete will be reinforced, either with reinforcing bars or with steel fiber reinforcement in the shotcrete itself. Hence, the overstressing will result in the formation of plastic hinges with a high residual load-carrying capacity. The heavy concrete lining section in these locations can easily accommodate any weakness in the shotcrete lining.

This analysis does not include the contribution of the fiberglass face reinforcement that would probably be used in this case, as illustrated in Fig. 17. While it is possible to make crude estimates of the effectiveness of this reinforcement, on the basis of the axi-symmetric analysis used to produce Fig. 4, this is seldom done because there is no simple way to incorporate these estimates into a two-dimensional analysis. The current method used to choose the capacity and density of the face support is to make it roughly equivalent to the rockbolt pattern used in the tunnel walls. The length is generally the same as that of the forepoles.

In this example, the final concrete lining is un-reinforced and the analysis indicates that the stresses induced in the lining are well within allowable working loads, even under the condition of full external water pressure. In finalizing the lining design, it would also be necessary to check for any possible adverse effects from eccentric loading or thermal stresses.

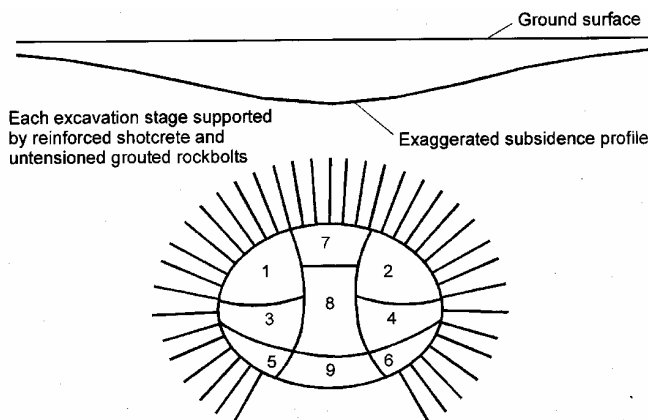

Fig. 18: Excavation and support stages for an underground station of the Athens Metro. Temporary support consists of double wire mesh reinforced 250 - 300 mm thick shotcrete shells with embedded lattice girders or steel sets.

Another example of a large excavation in very poor quality rock is illustrated in Fig. 18. This is a 16.5 m span excavation for one of the underground stations of the Athens Metro, described in a paper by Kavvadas et al (1996). The cover over the excavation crown is 15 to 20 m and the principal problem is one of surface subsidence rather than failure of the rock mass surrounding the openings. The rock mass is poor quality Athenian schist and the multiple excavation and support stages illustrated in Fig. 18 are designed to ensure that a continuous reinforced shotcrete shell is created. This ensures that the deformation of this rock mass is kept to a minimum.

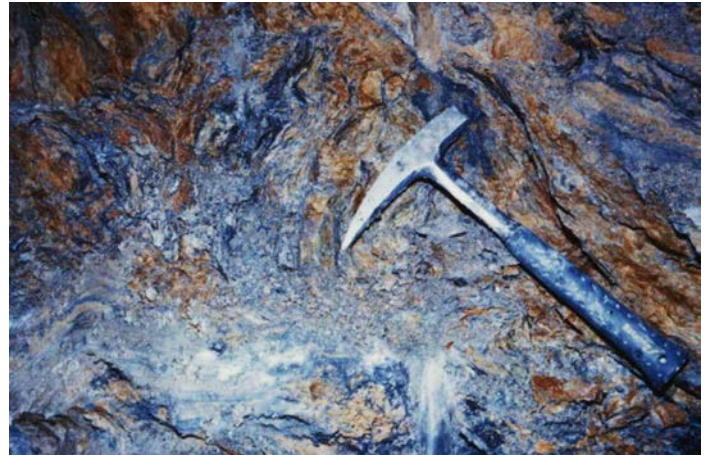

Fig 19: Appearance of the very poor quality Athenian schist at the face of the side heading of the Olympion station illustrated in Fig. 20.

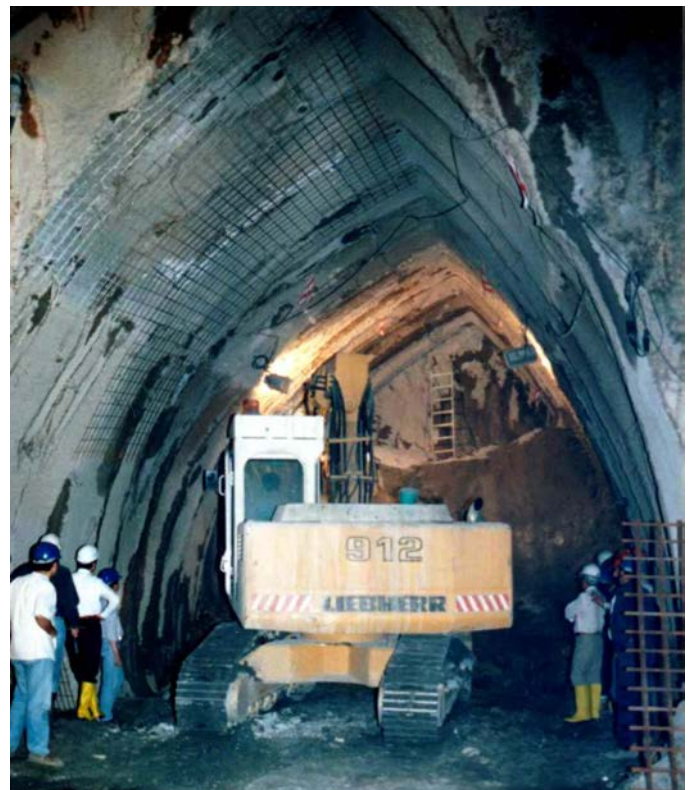

Fig. 20: Side drift in the Athens Metro Olympion station excavation.

The Academia, Syntagma, Omonia and Olympion stations were constructed using the method illustrated in Fig. 18. During the construction of the Omonia station, the maximum vertical displacements of the surface above the centre-line of the station amounted to 51 mm. Of this, 28 mm occurred during the excavation of the side drifts, 14 mm during the removal of the central pillar and a further 9 mm occurred as a time dependent settlement after completion of the excavation. According to Kavvadas et al (1996), this time dependent settlement is due to the dissipation of excess pore water pressures that were built up during excavation.

The appearance of the rock mass in one of the Olympion station side drift excavations is illustrated in Fig. 19 and Fig. 20.

HANDLING WATER IN TUNNEL CONSTRUCTION

The presence of water can cause significant problems during tunneling as a result of strength reduction due to either physical deterioration of the components of the rock mass or the reduction of effective confining stress due to pore water pressure. The physical deterioration of the rock mass can usually be estimated by tests carried out under conditions as close as possible to those anticipated underground. Appropriate support measures can then be designed to accommodate this strength reduction or to seal rock types such as shales that are particularly sensitive to moisture change.

In the case of water pressure, the tunnel itself generally acts as a drain during construction and hence these pressures are not usually a problem. However, if water is trapped behind an impermeable fault zone or similar geological barrier, the water pressure may cause a rock mass strength reduction as described above. In addition, a sudden release of this water pressure can give rise to dangerous operating conditions in the tunnel. Where such water barriers are anticipated it is generally prudent to use probe-holes ahead of the face in order to gain as much advance warning as possible.

The design of tunnels in impermeable rock masses should include a full effective stress numerical analysis.

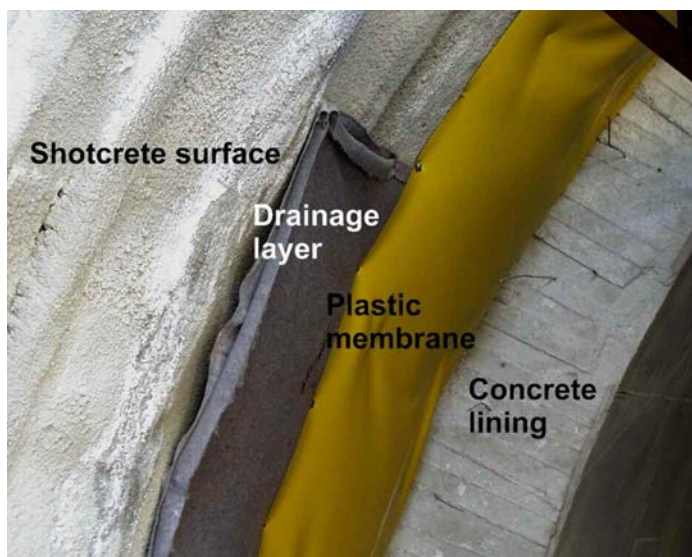

Fig. 21: A final concrete lining backed by a plastic membrane and a geotextile drainage layer in a large transportation tunnel.

A plastic membrane backed by a geotextile drainage layer generally surrounds the final concrete linings for most transportation tunnels. This layer leads water into drainage pipes in the base of the tunnel from where it flows under gravity to one of the portals. This system usually works well and the design of the concrete lining can be carried out on the assumption that there is no external water pressure. There are, however, special circumstances in which drainage is not permitted and where the water table has to be allowed to return to its pre-tunneling level. For example, in tunneling under national parks or environmentally sensitive areas, this is a common requirement. Under these conditions the final concrete lining must be designed to carry the full water pressure. This type of design consideration was included in Fig. 16.

In water transmission tunnels the concept of a “leaky” lining is sometimes accepted. In areas of very high external groundwater pressure the lining is intentionally punctured by drain holes so that the pressure difference across the lining is minimized. This is obviously only possible where the internal pressure is lower than the external pressure and where the quality of the external water entering the system is acceptable.



Fig. 22: The occurrence of large volumes of water can give rise to difficult construction problems in tunnels.

One of the most difficult problems to deal with in tunneling is that of very large quantities of water such as illustrated in Fig. 22. The geotechnical problems discussed above are not an issue here but rather the problem is simply dealing with the piping and pumping capacity required to handle the volume of water. This problem can be even more severe when the water temperature is high as a result of geothermal activity and when it is essential to pipe the water away from the face as quickly as possible in order to reduce the temperature and humidity at the working face. It may also be necessary to supply cooling in the form of refrigerated air or loads of ice dumped at the face to lower the temperature to an acceptable level. There are no theoretical solutions to these problems; it is a matter of organization and having appropriate and adequate resources available on site.

SQUEEZING AND TUNNEL BORING MACHINES

The photograph reproduced in Fig. 8 may give the impression that tunnel boring machines (TBMs) are unsuitable for use in squeezing ground conditions. This is by no means the case since, if the squeezing conditions are recognized in advance, machines can be designed to deal with this problem. Dowden and Cass (1991) and Babendererde (1989) have described machines where the outer shield consists of a number of blades, each one of which is supported on hydraulic rams so that the blade can move independently in both axial and radial directions. The machine advances by a “shuffle-shoe” process that is capable of accommodating squeezing. A machine of this type, illustrated in Fig. 23, was used to excavate a pilot tunnel for the Freudenstein tunnel in Germany.

Face instability is not generally a problem because, when the machine is stationary, the presence of the cutting head provides effective face support. When the machine is advancing, any squeezing is excavated as part of the cutting process. The final lining generally consists of pre-cast concrete segments that are placed directly behind the machine. If necessary, compressible elements can be incorporated into the joints of the segmental lining in order to accommodate squeezing of the tunnel behind the machine.



Fig. 23: Blade shield tunnel boring machine for squeezing ground conditions. The shield consists of parallel blades that are supported on hydraulic rams that can operate independently. Photograph provided by Dr Siegmund Babendererde.

TUNNEL EXCAVATION AND SUPPORT COSTS

It can readily be appreciated that the costs associated with these special tunnel excavation and support methods can be high. Fig. 24 summarizes typical tunnel costs (in 1999 US\$) for large tunnels in difficult ground. These costs are for excavation and support only and do not include the cost of final concrete lining or the tunnel fittings (ventilation, lighting, rails, roadway etc.). These costs were incurred in major projects currently under construction in various parts of the world and, while every care was taken to ensure that the information is as accurate as possible, the reader should exercise care in using this

information since local conditions may give rise to significant variations in costs. In particular, costs associated with change orders and claims can give rise to very much higher costs than those indicated in Fig. 24.

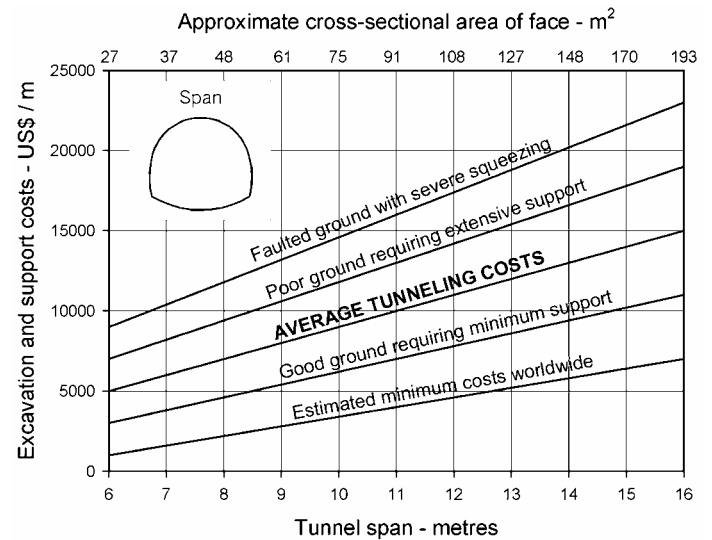

Fig. 24: Approximate costs for tunnel excavation and support (1999 US\$). These costs do not include concrete lining, tunnel fittings or tunnels driven by TBMs.

CONCLUSIONS

The demands of infrastructure development have increased demands for the construction of large tunnels in rock masses of very poor quality. Problems with stability of the both the tunnel occur when rock mass strength is less than one fifth of the in situ stress level. A method for estimating the severity of squeezing problems that occur under these conditions is presented. Case histories of tunnel squeezing are discussed and various support options for controlling the stability of the face and the tunnel are summarized. Two practical examples are included to demonstrate how some of these support options can be incorporated into a tunnel design. The use of tunnel boring machines (TBMs) in squeezing ground and the costs of large tunnels in various ground conditions are briefly reviewed.

ACKNOWLEDGEMENTS

Dr Mark Diederichs acted as a sounding board and reviewer during the preparation of this manuscript and his assistance is gratefully acknowledged. Special thanks are also due to Dr Siegmund Babendererde, Professor Paul Marinos, Professor Michael Kavvas, Mr Nikos Kazilis, Dr Nikos Koronakis, Dr Piergiorgio Grasso, Professor Sebastiano Pelliza, Dr Trevor Carter, Dr Walter Steiner, Professor Wulf Schubert, Professor Bhawani Singh and Dr J.C. Chern who have generously shared their ideas and experience in many discussions on tunneling. The useful comments made by the ASCE appointed reviewers of this manuscript are gratefully acknowledged. Finally, the author thanks his wife, Theo, for proofreading of the manuscript.

APPENDIX I – CASE HISTORIES OF SQUEEZING TUNNELS

Tunnel name, location and rock type	Depth H - m	σ_{cm} - MPa	σ_{cm}/H	Tunnel span - m	Closure - m	Strain ϵ %	Comments
1. Yacambu-Quibor, Venezuela (graphitic phyllite)	600	1.0	0.06	5.5	5	>30	Extreme squeezing, stability controlled by yielding steel sets (Sánchez Fernández and Terán Benítez, 1994).
2. Nathpa Jhakri headrace tunnel, India (fault zone)	300	0.6	0.25	10	2	20	Severe squeezing, stability controlled by forepole umbrella (Hoek, 1999)
3. Maan headrace tunnel, Taiwan (sandstone / shale)	200	1.6	0.33	6.5	0.1	1.5	Mild squeezing with local shotcrete damage (Chern et al, 1998)
4. Maan project, Adit A, Taiwan (sandstone / shale)	200	0.7	0.14	6	0.22	3.7	Large squeezing with severe support damage (Chern et al, 1998)
5. New Tienlun headrace tunnel, Taiwan (fault zone)	400	0.7	0.07	6.5	0.9	14	Severe squeezing with local tunnel collapse (Chern et al, 1998)
6. Mucha tunnel, Taiwan (sandstone / shale)	110	1.4	0.49	16	0.16	1	Stable tunnel (Chern et al, 1998)
7. Mucha tunnel, Taiwan (fault zone)	120	0.28	0.09	16	2.4	15	Severe squeezing with local tunnel collapse (Chern et al, 1998)
8. Pengshan tunnel, Taiwan (sandstone / shale)	140	1.9	0.55	12	0.01	0.11	Stable tunnel (Chern et al, 1998)
9. Maneri-Uttarkashi power tunnel, India (metabasics)	800	2*	0.1	4.75	0.43	9	Severe squeezing, damage to sets and concrete lining (Goel et al, 1995)
10. Chibro-Khodri tunnel, India (crushed red shale)	280	0.7*	0.1	3	0.01	2.8	Moderate squeezing, stabilized by circular steel sets (Singh et al, 1992)
11. Giri-Bata tunnel, India (slates)	380	0.8*	0.08	4.2	0.3	7.6	Large squeezing with deformation of steel sets (Singh et al, 1992)
12. Giri-Bate tunnel, India (phyllites)	240	0.7*	0.1	4.2	0.38	9	Severe squeezing with buckling of steel sets (Singh et al, 1992)
13. Loktak tunnel, India (shale)	300	0.7*	0.1	4.8	0.34	7	Large squeezing, supported by rock bolts, shotcrete and sets (Singh et al, 1992)
14. Maneri Bhali Stage I, India (fractured quartzite)	350	1*	0.1	4.8	0.38	7.9	Large squeezing with buckling of steel sets (Singh et al, 1992)
15. Maneri Bhali Stage II, India (sheared metabasics)	410	3*	0.28	7	0.2	3	Mild squeezing (Singh et al, 1992)
16. Maneri Bhali Stage II, India (Metabasic rocks)	480	3*	0.24	2.5	0.06	2.5	Mild squeezing (Singh et al, 1992)

* Estimated from descriptions provided by authors and from personal experience of Indian rock types.

APPENDIX II – REFERENCES.

Babendererde, S. (1989). "Fortschritte beim mechanischen Vortrieb großer Tunnelquerschnitte." *Eisenbahntechnische Rundschau*, Oktober, 1989, 621-623.

Brown, E.T., Bray, J.W., Ladanyi, B., and Hoek, E. (1983). "Ground response curves for rock tunnels." *J. Geotech. Engrg., ASCE*, 109(1), 15-39.

Carranza-Torres, C., and Fairhurst, C. (1999). "General formulation of the elasto-plastic response of openings in rock using the Hoek-Brown failure criterion." *Int. J. Rock Mech. Min. Sci.*, 36(6), 777-809.

Chern, J.C., Yu, C.W., and Shiao, F.Y. (1998). "Tunnelling in squeezing ground and support estimation." *Proc. Reg. Symp. Sedimentary Rock Engineering*, Taipei, 192-202.

Dowden, P.B., and Cass, D.T. (1991). "Shielded TBM's – matching the machine to the job." *Proc. R.E.T.C., Seattle*, 787-801.

Duncan-Fama, M.E. (1993). "Numerical modeling of yield zones in weak rocks." *Comprehensive rock engineering*, J.A. Hudson, ed., Pergamon, Oxford, 2, 49-75.

Fenner, R. (1938). "Untersuchungen zur erkenntnis des gebirgsdruckes". *Gluckauf*, 74, 681-695 and 705-715.

Goel, R.K., Jethwa, J.L., and Paithankar, A.G. (1995). "Tunnelling through the young Himalayas – a case history of the Maneri-Uttarkashi power tunnel". *Engrg. Geol.*, 39, 31- 44.

Hoek, E. (1999). "Putting numbers to geology – an engineer's viewpoint". *Q. J. Engrg. Geol.*, 32, 1-19.

Hoek, E., and Brown, E.T. (1980). "Empirical strength criterion for rock masses". *J. Geotech. Engrg., ASCE*, 106(9), 1013-1035.

Hoek, E., and Brown, E.T. (1997). "Practical estimates of rock mass strength." *Int. J. Rock Mech. Min. Sci. & Geomech. Abst.*, 34(8), 1165-1186.

- Hoek, E., and Marinos, P. (2000). "Predicting tunnel squeezing problems in weak heterogeneous rock masses." *Tunnels and Tunnelling International*. In press
- Kavvadas M., Hewison L.R., Lastaratos P.G., Seferoglou, C. and Michalis, I. (1996). "Experience in the construction of the Athens Metro." *Proc. Int. Symp. Geotechnical Aspects of Underground Construction in Soft Ground*, R.J. Mair and R.N. Taylor, eds., City University, London, 277-282.
- Lunardi, P. (2000). "The design and construction of tunnels using the approach based on the analysis of controlled deformation in rocks and soils." *Tunnels and Tunnelling International special supplement, ADECO-RS approach*, May 2000.
- Sakurai, S. (1983). "Displacement measurements associated with the design of underground openings." *Proc. Int. Symp. Field Measurements in Geomechanics*, Zurich, 2, 1163-1178.
- Sánchez Fernández, J.L., and Terán Benítez, C.E. (1994). "Túnel de Tránsito Yacambú-Quibor. Avance actual de los trabajos de excavación mediante la utilización de soportes flexibles aplicados a rocas con grandes deformaciones". *Integral approach to applied rock mechanics*, M. van Sint Jan, ed. Editec, Santiago, 1, 489-497.
- Schubert, W. (1996). "Dealing with squeezing conditions in Alpine tunnels." *Rock Mech. Rock Engrg.* 29(3), 145-153.
- Serafim, J.L., and Pereira, J.P. (1983). "Consideration of the geomechanical classification of Bieniawski." *Proc. Int. Symp. on Engineering Geology and Underground Construction, Lisbon 1(II)*, 33-44.
- Singh, B., Jethwa, J.L., Dube, A.K. and Singh, B. (1992). "Correlation between observed support pressure and rock mass quality". *Tunnelling Underground Space Tech*, 7(1), 59-74.
- Terzaghi, K. (1925). "*Erdbaumechanik auf Bodenphysikalischer Grundlage*." Franz Deuticke, Vienna, Austria, 212-214.
- Terzaghi, K. (1946). "Rock defects and loads in tunnel supports." *Rock tunneling with steel supports*. R.V. Proctor and T.L. White, eds., The Commercial Shearing and Stamping Co., Youngstown, Ohio, 17-99.